



Wind Industry in Germany

Economic report
An overview of the
German wind industry

Companies
Leading companies present
their products and services

Industry directory
Around 400 addresses –
easy access to the right contact

2021



INTERNATIONAL

Wind Industry in Germany

2021

BWE INDUSTRY REPORT



Editorial



Dear readers,

Dear readers,
The wind energy sector is set to experience another boom. For years, Germany has been a key anchor market for the industry. The market cuts in the period 2018 to 2020, caused by law, are therefore not only very difficult for Germany but also for European energy and climate policy. Despite the significant reduction in new installations, Germany was still ranked third in Europe in 2019 in terms of capacities (second for offshore wind, fourth for onshore wind). This underscores the importance of the German market.

Today the situation has changed. Policy-makers have woken up, impressed above all by the many millions of young people around the world who are demonstrating for more climate protection under the banner of Fridays for Future. In Germany and Europe, climate protection has gained importance. In view of the challenges ahead, Germany has agreed to phase out coal and amended key legislation: Although the new Renewable Energy Sources Act 2021 could still be more ambitious, it does at least set some clear goals. In Europe, the European Commission is backing the Green Deal, and the European Parliament is demanding a 60% reduction in greenhouse gas emissions. Framework conditions are changing in a positive way with respect to climate protection, and with this for renewables.

Wind energy will be the workhorse in the modern, CO₂-free energy industry. In Germany, we overtook coal as an energy source in 2019. In 2020, we will be seen to take a big leap in terms of energy

production. We are at the heart of the new energy world and are taking on an ever greater share of responsibility.

The German wind energy market is about to stage a comeback. The rising number of approvals is one of the building blocks, which the sector has worked hard and mostly independently to achieve. Repowering old turbines that are no longer covered by the funding model of the Renewable Energy Sources Act needs to become another building block. While the current turbine stock has an average capacity of 1.8 MW, newly approved turbines have an average capacity of 4.2 MW, indicating the enormous potential of repowering. Germany is the largest repowering market in the world, which offers huge opportunities to the manufacturing industry as well as industrial customers.

Policy-makers have taken a wait-and-see approach to the energy market over recent years. Other economic sectors were more in focus. Now those responsible are recognising the need to act. If this succeeds – and the first signs are encouraging – we can stage a comeback. The sector is ready for it. We want Germany to re-discover its strong economic role and to speed up implementation of the zero-emission energy sector.

Yours faithfully,

Hermann Albers,
President, German Wind Energy
Association (BWE)

The wind industry can be a cornerstone of green recovery



Ben Backwell,
CEO, Global Wind Energy Council (GWEC)

Wind power is one of the fastest growing industries in the world, with over 650 GW of capacity now installed worldwide and new markets emerging to open up new opportunities globally for this clean energy technology. Driving this growth are market-based mechanisms like auctions, innovations in technology and business models, growth of the corporate PPA market, as well as an increase in policy ambition from governments – but is this enough to accelerate growth to the levels needed to decarbonise our energy system and remain on a 1.5°C pathway?

While 2020 was expected to be a record year for wind energy with 76 GW of new installations forecasted, the impacts of the COVID-19 crisis have temporarily slowed down growth, but the wind industry can emerge stronger than ever if the right policies are put in place. There is broad consensus that wind and renewable energy can play an important role in helping economies to stimulate economic recovery in the wake of the COVID-19 pandemic, with many voices calling for a ‘green recovery’.

But governments so far have been slow to introduce concrete measures to promote green recovery, and measures that have been taken vary wildly by region and country. Failure to act promptly risks missing the opportunity to unlock hundreds of billions of dollars in investment in the energy sector, while the world heads into a deeper-than-necessary economic recession.

The COVID-19 pandemic has demonstrated how governments in almost every country can take decisive action to keep economic life going when faced with a global crisis; now they need to act equally decisively to deal with the climate crisis and transform our energy sectors for good.

Wind power has already proven itself as a clean, scalable, and affordable renewable energy source around the world – and should be seen as a cornerstone of economic recovery. Ultimately, it is on all of us as an industry to ensure that policymakers recognise the enormous potential for wind power and other forms of renewable energy to drive sustainable jobs, investment and development around the world.

Focused, Innovative and Interactive

The year 2020 has been extremely challenging for many industries and their trade events, which are such important marketplaces. The wind energy sector is not an exception. We have all had to face up to the new situation and adapt. At first we postponed WindEnergy Hamburg to December; but today we have to accept that the current travel restrictions are making it impossible to hold an international trade event at our exhibition centre.

Therefore the world's leading wind industry expo will take place as a purely digital event in 2020 – the first digital trade fair we have ever held in Hamburg. For us this means reinventing the entire trade fair concept while immersing ourselves more deeply into the accelerating transformation of the trade fair sector.

Our new, state-of-the-art digital platform offers exhibitors and industry visitors many innovative features allowing them to get informed, share ideas and experiences, and do business. Furthermore, during WindEnergy Hamburg Digital, the two "WindTV"-streams will present WindEurope's Premium Conference as well as open programming for participants to learn and share expertise in a more creative and effective manner than at a conventional online event. A wide range of topics will be addressed, such as ways to develop new markets, permitting

procedures, community engagement, electrification, renewable hydrogen, the latest technologies, and the wind energy supply chain.

I am both eager to experience this entirely new WindEnergy Hamburg, and confident that it will fulfil its mission. As for the future, I am looking forward to seeing well-filled exhibition halls here in Hamburg once again, since nothing is more important than face-to-face interaction when it comes to building mutual trust and closing deals.

We all prefer looking each other in the eyes, touching exhibits with our own hands, and experiencing a trade fair with all our senses. This physical experience is irreplaceable. But as digital options are getting more refined and powerful, we will be able to use them to supplement our exhibitions at many levels, highlighting exhibitors all year long, and connecting even more people over a longer period of time.

WindEnergy Hamburg will continue to be the world's foremost meeting of the wind industry, and despite the unusual circumstances it will be able to present itself as the sector's key innovation platform. I am looking forward to this year's WindEnergy Hamburg and to welcoming you to this exceptional trade event!



Bernd Aufderheide,
President and CEO,
Hamburg Messe + Congress

Content

Economic report



THE GERMAN MARKET

Slight recovery in terms of expansion – pressure to act remains high 13
The industry is demanding that the planned government measures for more turbines be implemented.

CONTINUED OPERATION

Exploiting the potential of existing wind turbines 16
Older turbines could play an important role, for example in the production of green hydrogen.

NEW REVENUE MODELS

Electricity supply contracts cannot replace the German Renewable Energy Sources Act (EEG) 19
Long-term power purchase agreements (PPAs) between producers and consumers are becoming increasingly popular as a new revenue model.

DISMANTLING AND RECYCLING

Wind turbines are recyclable 23
Individual and system components can then be resold or reused.

GLOBAL MARKET

Increasing global expansion – Covid-19 clouds forecasts 26
More wind turbines were installed around the world, including in Europe, in 2019 than in 2018, which makes it the second-best year to date.

INTERVIEW with Ben Backwell, CEO GWEC “Despite the crisis ...” 29

Map of the world 33

THE LABOUR MARKET

The number of jobs continues to decline 34
Companies within the industry partially blame the German Federal Government and the current tendering system for this.

THE WETIX MOOD BAROMETER

A positive long-term assessment for the international wind industry 37
Results of the “WindEnergy trend:index” (WETix).

OFFSHORE

Limited expansion, positive outlook 40
The production of green hydrogen could provide a further boost for the industry.

PLANT ENGINEERING

Front runner dethroned, turbines continue to grow in size 43
In today’s still tense market situation, manufacturers are continuing to focus on efficiency through larger rotors, taller towers and increased rated power output.

DIGITALISATION

Artificial intelligence for the wind industry 49
The use of artificial intelligence is opening up additional ways to reduce costs and avoid downtime.

Briefly asked



The sector is driven by its actors. We have asked entrepreneurs of the German wind industry about their most important innovations, strategies and markets. Read their answers on **pages 15, 31, 46 and 51.**

Companies



Companies with innovative projects 52
 These pages are dedicated to companies whose new products, processes or methods ensure the continued development of the wind industry.



Manufacturers 90
 German manufacturers have a high share of the world market, reaching an export rate of 60 to 70 percent. The technology and efficiency of their turbines set standards and are sought-after globally.



Suppliers 102
 Manufacturers of wind turbines from all over the world buy systems and components in Germany. Years of experience of the operational side together with specific research and development projects are much in demand everywhere.



Start-ups 72
 Start-ups are entering the market with new ideas. A selection is presented on these pages. Be inspired by their innovative power.

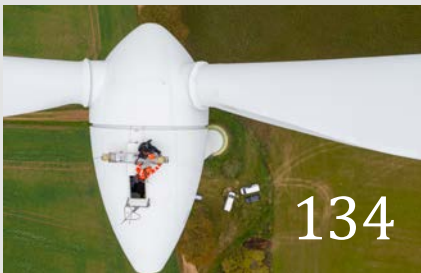

Service and logistics 134
 Planning, finance, transport, construction and marketing. The fields of planning and operation of wind turbines are a continuous growth market in Germany.



Associations 210
 BWE and GWEC are the voice of the national and international wind industry. The companies in the wind industry meet in the advisory boards of the BWE and he passes on technical knowledge to experts and newcomers alike.



Industry directory 218
 Almost 350 addresses of leading companies in the wind industry.

Companies A-Z 252
 Imprint 259
Category overview 261
 An overview of all categories is inside the back cover page.

ECONOMIC REPORT:

The German Wind Industry

Germany currently has about 30,000 wind turbines on its territory, corresponding to an installed output of almost 60,000 MW. Around 135,000 people are employed in the sector.

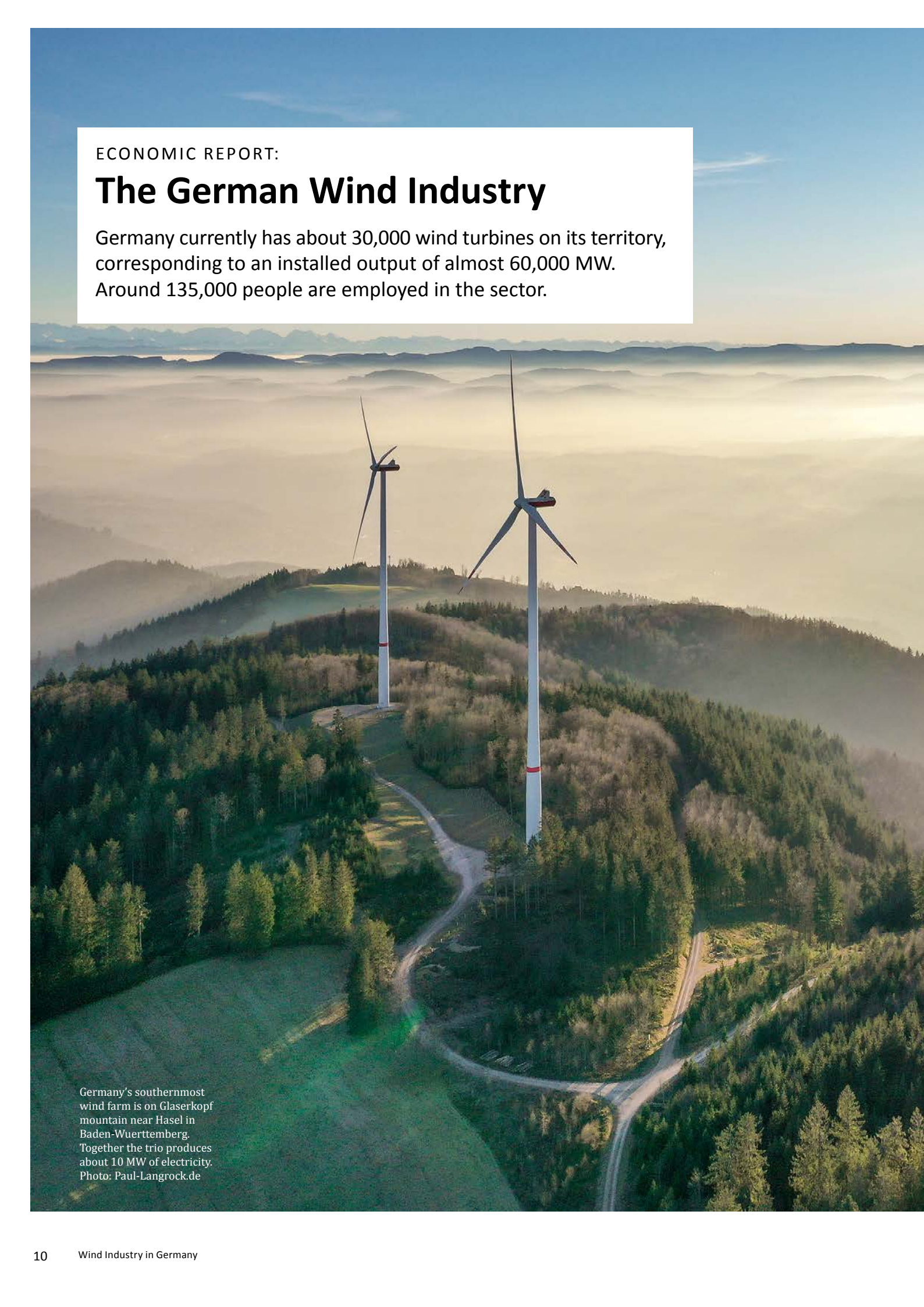

Germany's southernmost wind farm is on Glaserkopf mountain near Hasel in Baden-Wuerttemberg. Together the trio produces about 10 MW of electricity. Photo: Paul-Langrock.de





Meerhof wind farm in North Rhine Westphalia with a newly erected Enercon EP3 turbine next to an E-53.
Photo: Ulrich Mertens

THE GERMAN MARKET

Slight recovery in terms of expansion – pressure to act remains high

The number of new onshore wind turbines increased in the first half of 2020. By contrast, 2019 was the weakest year in terms of expansion since the introduction of the EEG. The industry is demanding that the planned government measures for more turbines be implemented.

There is still no real progress in the expansion of onshore wind energy in Germany. 178 wind turbines with a total rated output of 591 megawatts (MW) were installed in the first half of 2020. Although this was more than double the number of turbines as in the same period last year (86 turbines, 287 MW), it was still the second weakest half-year in the past 15 years. The figures were compiled by consultancy Deutsche WindGuard on behalf of the German Wind Energy Association (BWE) and the German Engineering Federation VDMA Power Systems.

Most new turbines are located in North Rhine-Westphalia, Brandenburg, and Lower Saxony. 40 turbines (124 MW) were installed as part of a repowering programme, 88 old turbines with a rated output of 84 MW were dismantled between January and June. According to Deutscher WindGuard, 29,456 onshore wind turbines with a total rated output of 54,418 MW are currently producing clean electricity in Germany.



29.456
onshore wind turbines
produce **54,418 MW**
of clean electricity
in Germany.

Expansion rate insufficient to meet climate targets

The associations are expecting an increase of at least 1500 MW for 2020 as a whole. The figure for 2019 was 1078 megawatts (325 turbines), the lowest level since the introduction of the EEG in 2000. Despite this slight recovery, the situation for the industry remains serious. The collapse of the German market has already resulted in redundancies in many companies. The low level of new construction is also pushing the German government's climate targets into the distant future. Lengthy approval procedures, a lack of space and complaints from residents and

environmentalists are among the reasons for the slow expansion. According to BWE President Hermann Albers: "Major obstacles to the expansion of onshore wind energy must now finally be removed. Only then will it be possible to expand renewables and achieve the climate protection goals." The processing of the Federal Ministry for Economic Affairs and Energy's onshore wind task list is, according to Albers, "more urgent than ever".

The Ministry presented a list of measures in October 2019 aimed at accelerating the construction of new wind turbines, for example by simplifying planning and approval procedures. However, many of the 18 points are still to be addressed. The German federal government passed a draft of a so-called Investment Acceleration Act in August 2020, the intention of which is to simplify approval procedures for wind farms. For example, the suspensory effect of legal action against wind farms is to be eliminated. In addition, the Higher Administrative Court or the Administrative Court will deal directly with the legal actions in future.



Erecting a V150-4.2 MW Vestas turbine at Neukirchen wind field in Thuringia. Photo: Jan Oelker

“The fact that lawsuits against approved wind turbines will no longer lead to the suspension of construction or planning in future” says Albers “is an important step in terms of planning security for operators and local authorities. We welcome the fact that the German federal government intends to make an initial contribution towards speeding up planning procedures. Shortening the appeals process has already proven its worth

in infrastructure projects. It ensures a judicial review and avoids protracted blockades in the court processes”.

However, Albers points out that more new approvals are needed first and foremost in addition to security for projects already approved. “We’re therefore calling on the federal government to implement the task list for onshore wind power in addition to the draft law that

has now been passed. We expect the government to act quickly and consistently whenever it is able to”.

Because the EEG funding for around 15,000 onshore wind turbines with a total rated output of around 16 gigawatts will end by the mid-2020s, BWE and VDMA Power Systems are also calling for “a clear repowering strategy geared towards the energy transformation”.

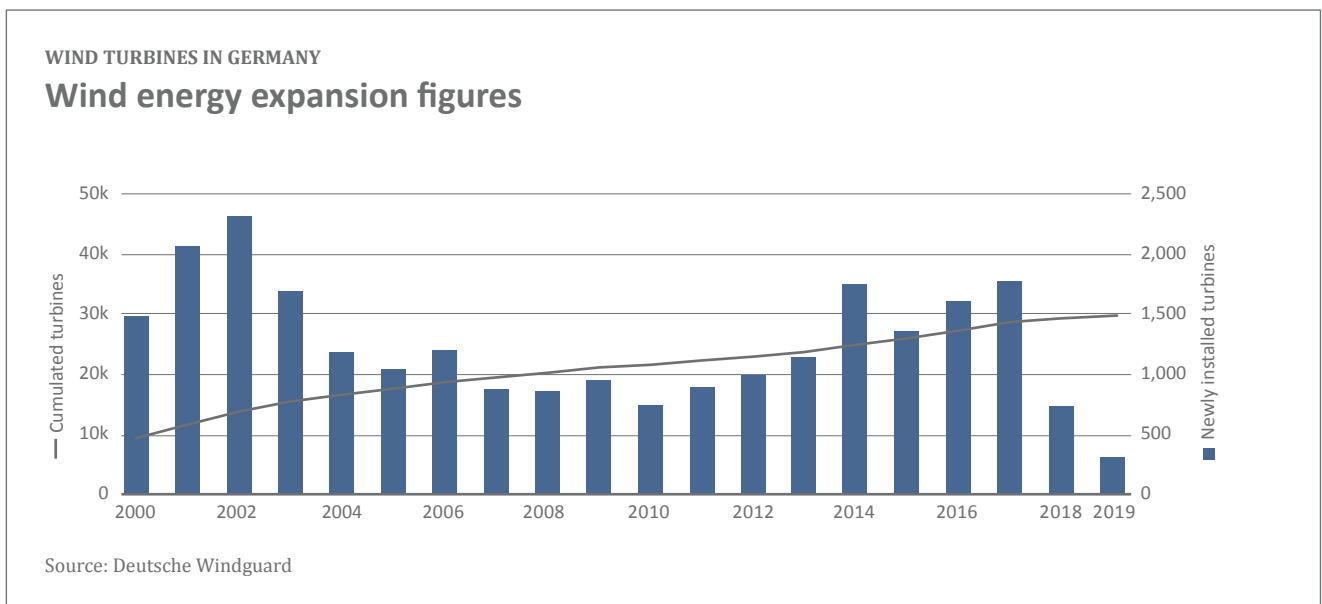

Question #1: “Which **actors** have a particular responsibility for promoting the German wind industry?”

“Public acceptance of wind energy is strongly influenced by what it looks like in the countryside. Innovative beaconing concepts such as the ARC-SIRIL in combination with reliable transponder-based demand-controlled night-time identification systems are a logical step towards improving this situation.”

OLAF SCHULTZ, Geschäftsführer,
Lanthan GmbH & Co. KG



“More sites, faster approval processes, quick repowering and fair framework conditions provided by a new EEG are important prerequisites for re-establishing onshore wind as a strong pillar of the energy transition. This is what politicians at all levels need to ensure if we are to reach climate policy goals.”

DIRK GÜSEWELL, Head of Project Development, EnBW
Energie Baden-Württemberg AG



“Asset managers have started to utilise the advantages of digitalisation. Thus, they are still at the beginning, which is why numerous assets still have an enormous potential for optimisation!”

MORIS GABRIEL, CCO,
greenmatch AG



“The energy turnaround is one of the most ambitious projects of our time. Due to the expiry of the subsidized remuneration within the EEG and political uncertainties, the industry is now facing enormous challenges.

In connection with the set climate targets, it is equally important to utilize existing capacities through repowering and the lifetime extension of wind turbines after 20 years.”

MARCO SCHAROBE, Partner,
IDASWIND GmbH



“Politicians, whose task is to clear the backlog of permits caused by overlong procedures and legal blockades. We are part of a powerful industry that can and wants to push forward with the energy transition.”

BJÖRN WENZLAFF, CEO,
Windwärts Energie GmbH

CONTINUED OPERATION

Exploiting the potential of existing wind turbines

The Covid-19 pandemic is making it considerably more difficult to continue operating wind turbines that will fall outside the EEG as of 2021. Yet older turbines could play an important role, for example in the production of green hydrogen.

Assuming that they could not be replaced by new, more efficient systems through repowering, when the subsidies granted under the German Renewable Energy Sources Act (EEG) end for thousands of wind turbines in 2021, the best option in terms of the energy transition and the German government’s climate targets would be for them to remain connected to the grid and to continue to produce green electricity. In most cases, the financial sense of their continued operation depends on the price at which electricity is traded on the commodity markets, which is where the electricity from the wind turbines has to be sold. Due to the prevailing low prices – according to Agora Energiewende, the

electricity price on the futures market exchange in 2019 was 4.7 cents per kilowatt hour (kWh) on average - this is only worthwhile when the maintenance and operating costs are low. This means that all costs must be reduced as far as possible.

The situation has worsened considerably due to the Covid-19 pandemic. In some cases, the price of electricity has fallen to below 2 cents due to the low demand. Operators of old wind turbines are therefore faced with considerable problems when it comes to demonstrating that continuing operations are economically viable. According to studies, the turbine operating costs amount to 2.64 to 5 cents

per kWh produced, with the price strongly dependent on the type of turbine and the location quality. The situation resulted in various stakeholders, such as the state of Lower Saxony or the green electricity provider Naturstrom, presenting different ideas for the follow-up funding of old turbines. Lower Saxony’s Energy Minister Olaf Lies advocates an optional fixed price of 4.34 cents per kilowatt hour for a maximum of seven years, which, as he explains: “would ensure the continued operation of the old turbines where repowering is not an option, whilst at the same time helping to achieve the climate targets for 2030”.

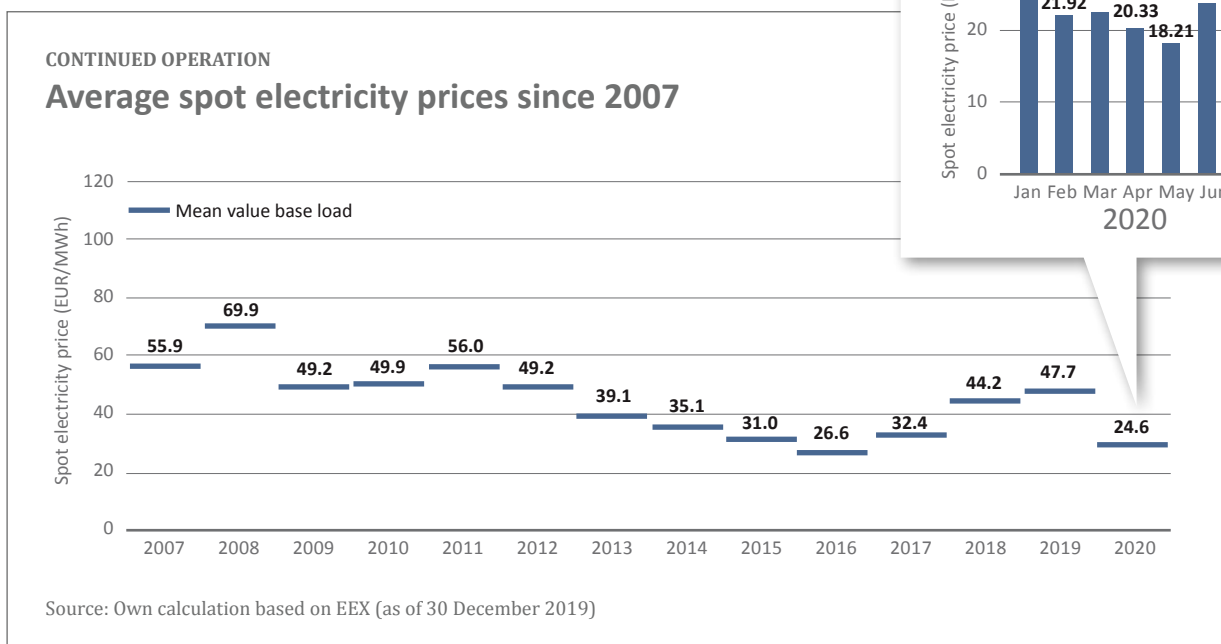



Heubusch wind farm near Meerhof. Photo: Ulrich Mertens

One potential solution: follow-up funding combined with fixed prices

Naturstrom's proposal envisages a charge of 3.2 ct/kWh, and, as Naturstrom board member Oliver Hummel explains: "depending on the size and location of the turbine, there would be various premiums and discounts in addition to this basic charge. Larger turbines at the best possible locations would receive 2.2 ct/kWh, whilst the upper limit for smaller ones at poorer locations would be 4.5 ct/kWh. In addition, the model would be limited to two years and would allow for a monthly switch to unrestricted marketing to energy traders. Not least, given the increasing demand for electricity due to electromobility and heat pumps", he continues, "we will very soon

"Until a comprehensive repowering strategy has been implemented, action must be taken now to avoid a disorderly reduction of existing capacities."

be needing more rather than less green electricity in Germany. In a situation like that, simply abandoning old plants to the vagaries of Covid-19 and shutting them down would be the opposite of what is needed".

Whilst the Federal Ministry for Economic Affairs and Energy does not recognise the need for follow-up funding, the German Wind Energy Association (BWE) is open to the measure: "Until a comprehensive repowering strategy has been implemented", BWE President Hermann Albers explains, "action must be taken now to avoid a disorderly reduction of existing capacities. Economic strategies are needed for turbines that will successively fall outside of the EEG system from 2021

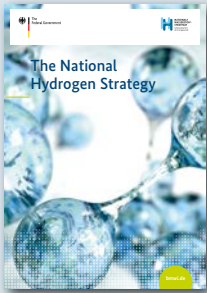

The National Hydrogen Strategy

By tabling the National Hydrogen Strategy, the Federal Government is providing a coherent framework for the generation, transport and use of hydrogen, encouraging the relevant innovations and investment. The Strategy sets out the steps that are needed to meet the German climate targets, create new value chains for the German economy and foster energy policy cooperation at international level.

It focuses in particular on the following goals:

- Establishing hydrogen technologies as a core element of the energy transition in order to decarbonise production processes using renewable energies
- Creating the regulatory environment for the successful market launch of hydrogen technologies
- Strengthening German companies and their competitiveness by supporting R&D and technology export surrounding innovative hydrogen technology
- Securing and shaping the future national supply of CO₂-free hydrogen and its derivatives

Source: www.bmwi.de

“The post-EEG turbines, for which EEG funding will gradually be phased out in the coming years, should be integrated as a first step.”

onwards. We cannot afford to lose CO₂-free production capacity”. The German Renewable Energy Federation (BEE) sees great potential for the production of green hydrogen using post-EEG wind turbines, as the German federal government’s National Hydrogen Strategy is heavily reliant on green hydrogen produced using renewable energies. According to the BEE, the total electricity demand will be 20 terawatt hours.

BEE President Simone Peter comments: “The post-EEG turbines, for which EEG funding will gradually be phased out in the coming years, should be integrated as a first step. Closely related to the production of green electricity, there is an immense dormant potential for the production of green hydrogen, which could be tapped without having to wait for the approval of new renewable plants. An appropriate regulatory framework is required now to achieve this. If these existing turbines are put to work, green hydrogen could be produced at an industrial scale as early as early 2021. You simply pool the turbines and get on with it”.

Numerous companies have also appeared on the scene in recent years, which support the operators in continuing operations or purchase their plants to continue operating them themselves.



Nordex lattice tower wind turbine at Lichtenau wind farm in Asseln. Photo: Ulrich Mertens

NEW REVENUE MODELS

Electricity supply contracts cannot replace the German Renewable Energy Sources Act (EEG)

Even in Germany, long-term power purchase agreements (PPAs) between producers and consumers are becoming increasingly popular as a new revenue model, especially in relation to the continued operation of wind turbines. However, according to experts, the EEG remains indispensable for the further expansion of wind energy.



A Power Purchase Agreement (PPA) ...

The success of the energy transition is due to the German Renewable Energy Sources Act (EEG): the fixed feed-in tariff paved the way for a major expansion, which in turn resulted in a rapid rise in the development curve for renewable technologies over the past 20 years and a rapid reduction in costs. Onshore and offshore wind turbines generated about 73 billion kilowatt hours of green electricity in the first half of 2020 – a new record. However, the industry is also searching for revenue opportunities beyond EEG payments, for example, through marketing platforms where renewable energy producers can sell their electricity directly to end users.

... is a long-term electricity supply contract between a producer and a consumer in the industrial, commercial or distribution sectors. A PPA provides protection for both parties over several years: the electricity producer is protected against falling and the consumer against rising electricity prices. However, much depends on the precise details in the contract.

Another option, so-called Power Purchase Agreements (PPAs), have also become increasingly common in Germany in recent years. In 2019, according to financial services provider Bloomberg New Energy Finance, clean energy PPAs totalling 19.5 gigawatts were signed in 23 different countries, the majority in the USA. This represents a 40 percent increase over the previous best figure from 2018 (13.6 GW).

More PPAs have also been signed in this country. For example, the Danish energy company Ørsted announced in early December 2019 that they had concluded the “world’s largest PPA” for the Borkum Riffgrund 3 wind farm in the North Sea with the chemical company Covestro, a

materials manufacturer based in Leverkusen which will “purchase 100 megawatts of green electricity at an indexed fixed price over 10 years starting in 2025”. As Martin Neubert, Executive Vice President and CEO of Ørsted Offshore, stated: “Our agreement with Covestro represents the first concrete step towards securing stable revenues for some of the electricity generated at the Borkum Riffgrund 3 wind farm, which is being constructed and operated without subsidies”.

Carbon dioxide as a new raw material: At this production plant in Dormagen, Covestro produces an important plastics component that is made with up to 20 % carbon dioxide. Photo: Covestro



Further PPAs were also concluded last year for onshore wind turbines which will no longer benefit from the EEG subsidy as of 2021. Hanse Windkraft, for example, announced that they had concluded a PPA for wind energy with Stadtwerke München (the Munich municipal utilities) and Siemens. Hanse Windkraft is a subsidiary of Stadtwerke München and specialises in

buying up wind farms which it then continues to operate. According to a statement by Hanse Windkraft: “Siemens will receive a large portion of the green electricity it needs for its new campus in Erlangen from wind turbines that will no longer be eligible for funding under the EEG as of 2021”.



Transparent, sustainable and forward-looking: Siemens is building a campus in southern Erlangen, which will be a research laboratory, administrative headquarters and meeting place at the same time. Photo.: KSP Architekten/Siemens AG

The topping-out crown for the first module of the Siemens Campus Erlangen has been set. Photo: Siemens AG



PPAs: additional costs compared to remuneration instruments

According to an analysis by the German Institute for Economic Research (DIW), although in an ideal world, PPAs are beneficial to both parties and experts also confirm their immense potential for Germany, they are not an appropriate replacement for the current EEG remuneration model and for the promotion of the expansion of wind energy, which has recently suffered a severe slump. “There are two drawbacks to long-term electricity contracts for new investments in renewable energies”, say the authors of the report: First, the risk of default on the part of the electricity consumer makes

⚡
20,9
TWh of electrical energy
(roughly equivalent to the annual electricity production of two nuclear power plants) was generated by wind power alone in Germany’s most profitable month to date (February 2020).

it difficult to obtain favourable funding for the projects, which raises the capital costs; this in turn increases the overall costs, particularly in the case of capital-intensive renewable energies. Second, financing costs increase for the electricity consumer because rating agencies deem long-term electricity contracts to be liabilities, which affects creditworthiness”. Privately secured long-term electricity contracts would therefore result in additional costs of around 29 percent compared to secure remuneration instruments. “That amounts to around 3 billion euro per year for 2030.”

For large German steel companies as well as for the major energy providers “concluding the privately secured PPAs necessary for the switch to 100 percent renewables would far exceed their financial power”. PPAs could “play an important role in extending the service life of existing renewable energy plants”, the DIW experts conclude. “However, they can only be used extensively for major new investments at a considerable additional cost”.

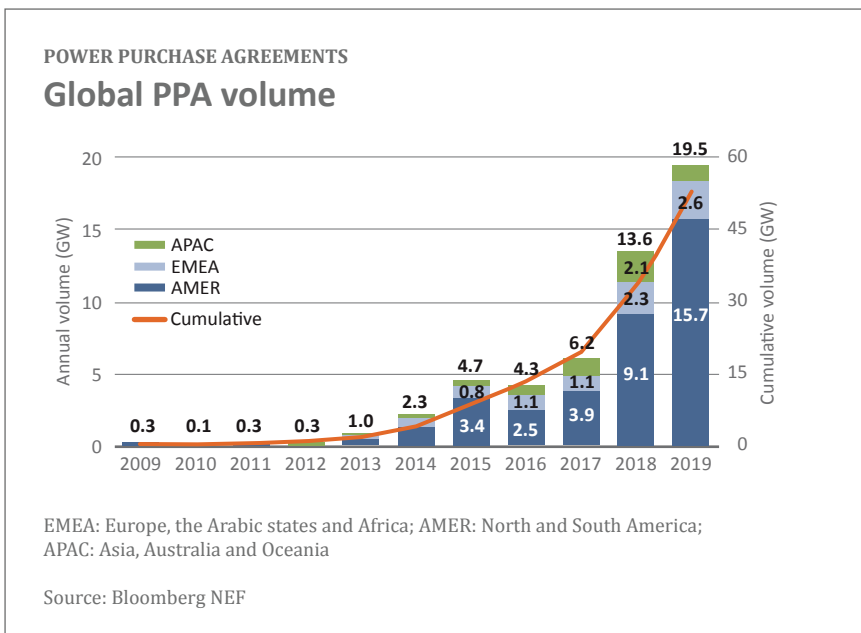

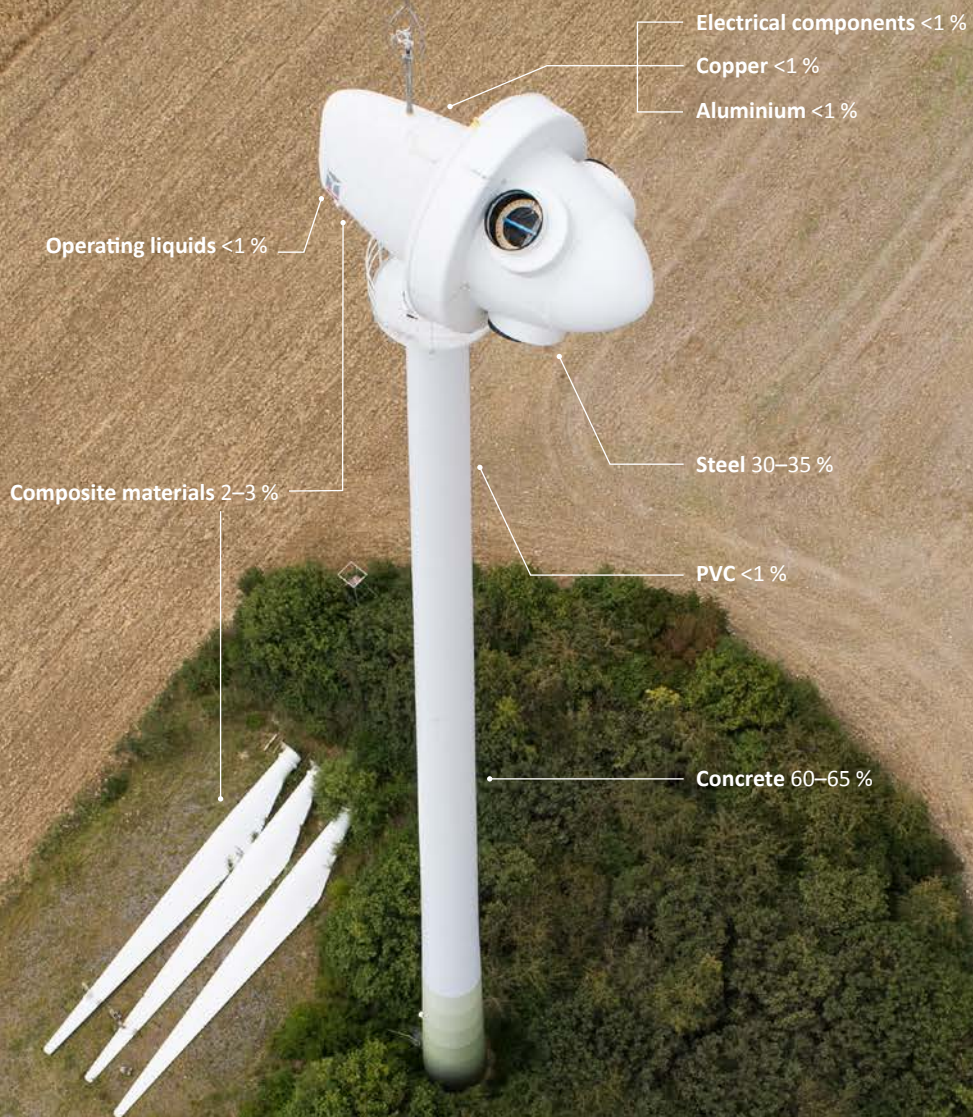

Proportion of construction materials in the total weight of a wind turbine (as a percentage)

Source: own graphic, based on data of Veolia Deutschland GmbH

DISMANTLING AND RECYCLING

Wind turbines are recyclable

Wind turbines can be dismantled without problems. Individual and system components can then be resold or reused. Recycling the machines, which are mainly made of steel and concrete, also presents no problems.

Wind turbines that reach the end of their service and operational life need to be dismantled. The same applies when a replacement by a new, more powerful turbine is planned as in the case of so-called repowering. The approval procedure already stipulates that wind turbines must eventually be completely dismantled and the grounds upon which they are erected be restored to original condition. In view of the fact that, as of 2021, thousands of turbines will no longer be eligible for subsidies under the German Renewable Energy Sources Act (EEG – see p. 16), the issue of dismantling is set to become increasingly relevant.

As the German Wind Energy Association (BWE) explains: “The dismantling conditions are usually outlined in the building permit and clarified in the lease agreement”. Federal state legislation regulates “the form in which the building permit authorities ensure compliance with this mandatory requirement”. In some federal states the dismantling costs must be covered by a surety prior to the start of the project.

Secondary market for old systems not very lucrative

There is a secondary market for old turbines. They can be sold abroad, for example, where they can continue to produce electricity. However, as experts point out, the market is changing: older mid-sized

turbines are already failing to finding buyers and revenues from their sale are also decreasing. This trend is all the more likely to continue if more turbines are dismantled as of 2021. Operators, therefore, will incur costs for dismantling and disposal as standard practice.



The dismantling of a wind turbine at Eisenhof/Meerhof wind farm. . Photo: Ulrich Mertens

“Put it on the market early”



BERND WEIDMANN,

founder and managing director of the online marketplace wind-turbine.com, talks about the secondary market for wind turbines.

How does the secondary market work?

Primarily via online platforms that bring buyers and sellers together. It is important to consider who is actually behind the ads – brokers or operators? Turbines are almost exclusively purchased abroad.

Which components are easiest to resell?

Often it is gearboxes, control elements, transformers, switch cabinets and generators from different manufacturers. Some systems which use permanent magnets also use neodymium, an extremely valuable raw material. Our advice is not to dispose of this material carelessly. There is great demand for it on the market and thus the potential of minimising dismantling costs.

Is there a demand for complete systems?

Yes, the trend is for 1.5–3 MW turbines. Smaller systems are often sought after as a way of acquiring large components or replenishing spares holdings.

Many more will be offered for sale as of 2021 ...

That’s correct: prices for complete systems will certainly fall, hence our tip to offer systems and large components for sale at an early stage. It can take several months to conclude a sales contract.

Turbines are always dismantled with the aid of a crane, whereby the individual components are dismantled one-by-one from top to bottom, taking due account of occupational safety and environmental aspects, starting with the rotor blades and the nacelle. Concrete towers can be dismantled either with the aid of a wrecking ball or so-called demolition shears. Blasting is another suitable option, also for the foundations. Furthermore, it is possible to use a jackhammer attached to an excavator instead of the shovel to break up the foundations, which detaches the concrete from the steel reinforcement, after which the metal and concrete can be recycled separately. The concrete, for example, can be crushed to a certain size in a crushing plant before being used to construct such things as access roads to new wind turbines.

Rotor blades that are not to be resold or used as spare parts are cut into transportable pieces on the ground and transported away for further processing. If water is used during the cutting process, any dust or sludge is collected at source. Other components, such as gears or bearings, can also be refurbished and reused as used spares. The use of used spare parts is particularly useful in

continued operation plants, which need to be run as cost-efficiently as possible. All other materials and components are recycled. According to the BWE, “80 to 90 percent of the components, such as the metal-bearing turbine components, the electrical system in its entirety as well as the foundations and tower (steel, copper, aluminium and concrete components), can be recycled in established recycling cycles”.

Currently, the composite materials from which the rotor blades are made continue to present a recycling challenge. They usually consist of glass fibre or carbon fibre reinforced plastics. However, as the BWE points out, these are “nothing new for the recycling industry, as boat hulls, aircraft parts and other fibre composite components are also disposed of. In addition to thermal recycling, the industry is also putting a lot of work into the development of new raw material recycling concepts”.



The broken up foundations of a wind turbine at Elisenhof/Meerhof wind farm. Photo: Ulrich Mertens

GLOBAL MARKET

Increasing global expansion – Covid-19 clouds forecasts

More wind turbines were installed around the world, including in Europe, in 2019 than in 2018, which makes it the second-best year to date. However, many more would have been needed to meet the European climate targets.

Whilst the expansion of onshore wind energy in Germany slumped to its lowest level in 20 years in 2019, the year was described as “a great one for the wind industry” by the international umbrella organisation Global Wind Energy Council (GWEC). With 60.4 gigawatts (GW) installed on- and offshore around the world, it was the second-best year ever after the record year 2015 during which 63.8 GW were installed. The proportion of onshore wind energy production capacity installed in 2019 was just under 54.2 GW, whilst over 6 GW was installed offshore, which

represents an increase of 19 percent compared to 2018. According to GWEC’s annual Global Wind Report, the primary expansion drivers were China, the USA, the UK, India, and Spain, who together were responsible for 70 percent of new installations worldwide in 2019. “The Asia-Pacific region”, the report states, “continues to lead global wind energy development, accounting for 50.7 percent of new installations around the world last year, followed by Europe (25.5 percent), North America (16.1 percent), Latin America (6.1 percent) and Africa and the Middle East (1.6 percent)”.



Project in Sheyang, Jiangsu, China. Photo: Goldwind





Project in Dabancheng, Xinjiang, China. Photo: Goldwind

Expansion forecast lowered due to the Covid-19 pandemic

In terms of total installations, Germany ranks third behind China and the USA, followed by India and Spain. Together, these countries have installed 72 percent of the world’s wind turbines (with a total rated output of 651 GW). The GWEC expects the global expansion of onshore production capacity to reach 55 GW in 2020, which is roughly the same as in 2019. The association has revised its forecast downward due to the Covid-19 pandemic: installations were initially expected to total 70 GW, 28 GW of which would have been in Asia, 16 GW in North America and 10 GW in Europe.

“Climate neutrality and the Green Deal require Europe to install over double the volume of new wind power capacity as in 2019 every year.”

According to WindEurope, Germany was the European leader in the construction and commissioning of new wind turbines in the first half of 2020 with a total installed capacity of 587 megawatts (MW), followed by France with 494 MW. In Europe as a whole, a total of 5.1 GW of wind power was installed during this period (3.9 GW onshore and 1.2 GW offshore). The European total during the same period in 2019 was 15.4 GW – a 27 percent increase over the previous year. This, according to WindEurope, was enough to cover 15 percent of Europe’s electricity consumption. However, as Giles Dickson, CEO of WindEurope, points out, this proportion of wind energy is far from sufficient: “Climate neutrality and the Green Deal”, he explains, “require Europe to install over double the volume of new wind power capacity as in 2019 every year. This expansion needs to be driven by both offshore and onshore wind energy plant, which requires a new approach to planning and approvals and further investment in electricity grids. The national energy and climate plans for 2030 are of crucial importance in this context, and the EU must ensure that these are ambitious and implemented in a consistent manner”.

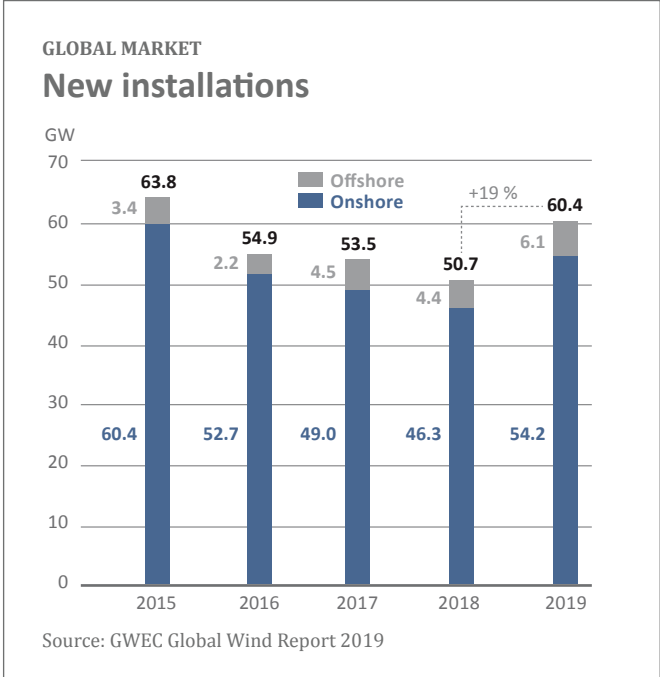

The high level of growth in global wind energy represents an opportunity for German companies. It is not only wind turbine manufacturers who, due to the faltering order situation in Germany, have been focusing increasingly on international markets for some time now. Project developers and service providers are also operating successfully abroad.

“Despite the crisis, 2020 has been an impressive year for the wind industry, especially for the offshore industry ...”

Mr. Backwell, how has 2020 been for the wind industry so far?

We expected 2020 to be a record year for the wind industry, with 76 GW of new capacity forecasted to be installed this year. The COVID-19 crisis has caused supply chain disruptions, delay of auction and projects, as well as economic uncertainty, which has impacted this original forecast.

However, compared to other energy sources, such as coal and oil where we have seen both a decrease in demand and fluctuating prices throughout the crisis, wind power will emerge from this crisis in a solid position. According to GWEC Market Intelligence, we should only see a decrease of 16 per cent compared to our original forecasts for this year, and the majority of this 16 per cent will be instead allocated to 2020.



AN INTERVIEW WITH
BEN BACKWELL

CEO, Global Wind Energy Council (GWEC)

Despite the crisis, 2020 has been an impressive year for the wind industry, especially for the offshore industry, which has met and even surpassed pre-COVID forecasts to reach astonishing levels of growth.

According to the latest report from BloombergNEF, a total of \$35 billion in offshore wind financings was reported in 1H 2020 – this is a 319 per cent increase from the same time last year. This investment will power 28 offshore wind farms globally, including the largest project ever in the Netherlands and 17 projects in China.

Do you expect emerging markets to become the primary drivers of growth for the wind industry in the coming years, or will growth be distributed evenly?

The key markets currently driving growth in both onshore and offshore wind remain the usual suspects, however, we do expect emerging markets to play an increasingly important role over the next decade to accelerate growth globally.

For onshore wind, China and the US remain the largest markets, together accounting for more than 60 per cent of new capacity in 2019. However, continued stable growth in Europe and the maturing of markets in Asia, Latin America and Africa will be key to sustain growth in the long-term, as installation rushes in both China and the US, which have been driving growth in recent years, will come to a halt by the end of 2021.



For offshore wind, Europe and China remain the largest markets, accounting for 59 per cent and 41 per cent of new installations in 2019 respectively. Yet, there are many promising emerging markets such as Japan, South Korea, and the US which will begin play an increasingly important role by the end of this decade.

Additionally, new technology developments such as hybridisation, floating offshore wind and Power-to-X are increasingly being implemented in both mature and emerging markets to increase the share of wind and other renewables in their energy systems. If policymakers and industry stakeholders embrace these new opportunities, we can accelerate the global energy transition to never-before-seen levels.

Do you think the current economic disruptions will slow the deployment of wind energy in the long term?

While we have seen a slow down of wind power deployment this year, this will not continue long-term and we will already see an uptick of activity in 2021 with installation rushes in China and the US, as well as the construction of projects that were scheduled to be installed in 2020. The fact is that wind power is an affordable and accessible energy source across the world, and investors and even oil and gas companies are waking up to this fact. Throughout the COVID-19 crisis, wind and other renewable energy sources demonstrated their resilience compared to other energy sources, and it is clear that we need to make our energy systems more sustainable and less dependent on fluctuating fossil fuel prices in the case of another crisis.

“From 2015 to 2019 alone, wind energy generated over \$652 bn in investments.”

However, the right policies and fit-for-purpose market design must be in place in order to encourage investment into the wind sector and even the playing field in order to ‘build back better’. Mechanisms such as introducing meaningful carbon pricing, implementing ‘No Harm’ criteria for investment schemes, scaling up green financing for emerging markets, implementation of regulation that provides long-term price visibility, and many more can be important tools for governments to cost-effectively accelerate their energy transition while simultaneously building more resilient economies.

Can wind energy contribute to the global economic recovery?

The wind industry can not only contribute but be a cornerstone for green recovery, allowing governments to renew critical infrastructure for a sustainable future while delivering local jobs, clean and affordable power, creating new investment opportunities and providing energy security to ‘future-proof’ economies long-term.

For starters, wind energy has been a massive source of capital investment – from 2015 to 2019 alone, wind energy generated over \$652 bn in investments. Ramping up installed wind capacity to above 2TW by 2030 would create additional annual investment of \$207 bn or over \$2 tn in total. The wind sector is also a major creator of skilled jobs

and community benefits, with international agencies estimating that direct and indirect jobs in wind energy will more than triple from 1.2 mn in 2019 to nearly 4mn by 2030 if deployment takes place at the necessary rate.

Ultimately, investments in wind and other renewables go much further than investments into fossil fuels in the long-term. The International Renewable Energy Agency (IRENA) estimates that each dollar spent to advance the global energy transition will bring a return of three to eight dollars. In addition, each million dollars invested in clean energy infrastructure creates double the jobs than if this was invested in the fossil fuel sector.

It is clear that wind power can be an important building block of green recovery, but governments need to act fast in order to harness the benefits that the wind industry can offer. In May 2020, GWEC along with signatories representing all the major OEMs, developers, supply chain, investors, and associations signed a statement that calls on governments to place wind power at the heart of their economic recovery plans, providing tangible actions that policymakers can take to realise this ambition. The full statement and more information on how wind power can contribute to a green recovery can be found on the GWEC website (gwec.net).

Question #2: “In which foreign markets is your company particularly active and why?”



“France and Ukraine – two large and very different countries with high energy demand or considerable ground to make up with respect to renewable energies.”

HEINER RÖGER, Geschäftsführer,
NOTUS energy



“We are constantly expanding our foreign activities, recently to the US and Taiwan, often hand in hand with the customer. Always taking into account the economic meaning and qualitative feasibility.”

MATTHIAS BRANDT, Director,
Deutsche Windtechnik AG



“Parallel to the German market, we have aligned ourselves with Scandinavia since 2019. Here Green Wind is gaining experience in a purely market price-driven electricity feed-in system. In addition, after ten years we are now returning to our roots; the company to Denmark, I to Sweden.”

MARTIN KÜHL, Managing Director,
Green Wind Group



“One of our most important foreign markets is North America, where most of the world’s wind turbines are installed, along with China. The North American market is also very open to new technologies and innovations.”

STEFAN BILL, Dipl.-Ing., Managing Director,
REWITEC GmbH



“Apart from our long-standing stable markets in France, Finland, Croatia and Taiwan, Poland and Chile are particularly exciting growth markets at present. We’d also like to establish ourselves in Sweden and Spain to enable our customers to benefit from our usual high quality standards there. Our customers are diverse and we want to be a local partner to investors, wherever that may be. True to the motto “think globally, act locally”, as good operational management is more than sitting in front of a computer screen.”

HENNING RÜPKE, Head of Business Development
International, wpd windmanager GmbH & Co. KG



“With local production facilities in China, India and the USA, Rittal serves the Asian and American focus markets of wind energy.”

FRANZISKA HAIN, Vertical Market Manager Energy,
Rittal GmbH & Co. KG, Rittal GmbH & Co. KG

Onshore 621,421 MW

Additional 2019: 54,206 MW;
Additional 2018: 46,345 MW

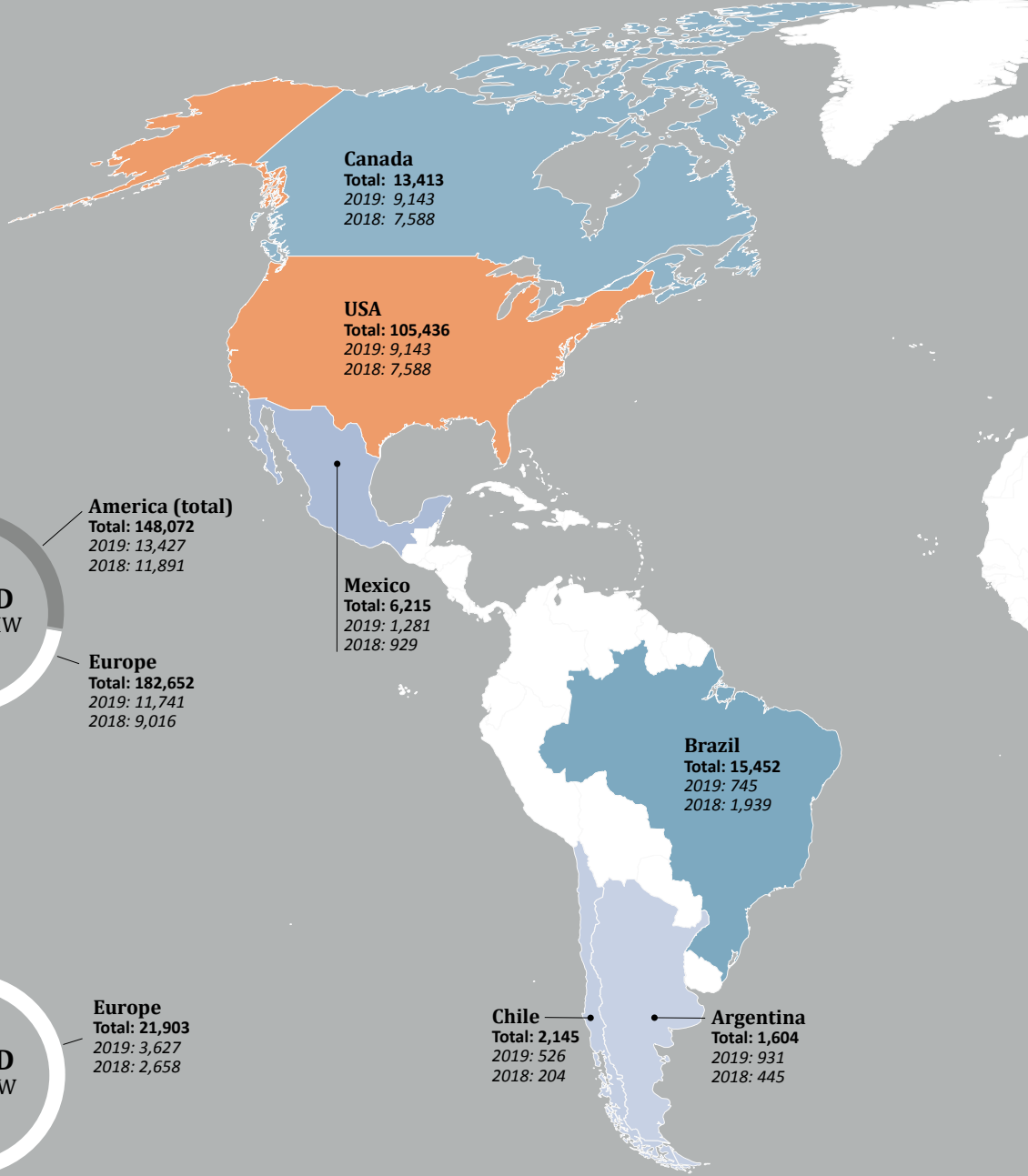
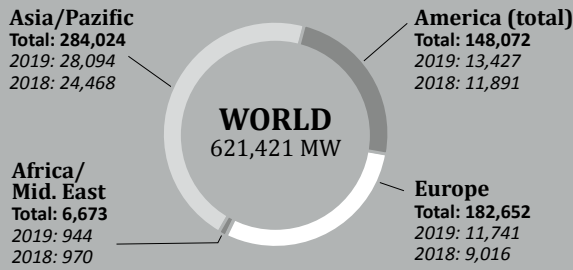

Offshore 29,136 MW

Additional 2019: 6,145 MW;
Additional 2018: 4,348 MW

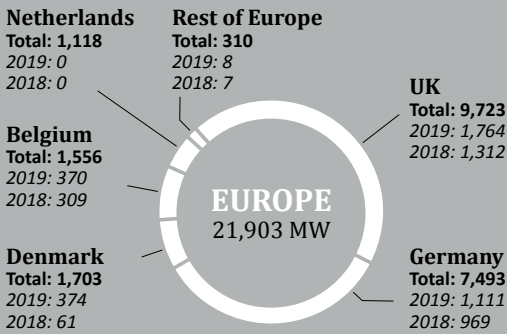
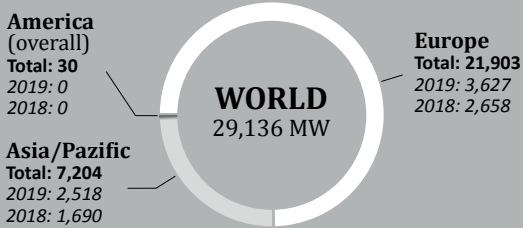

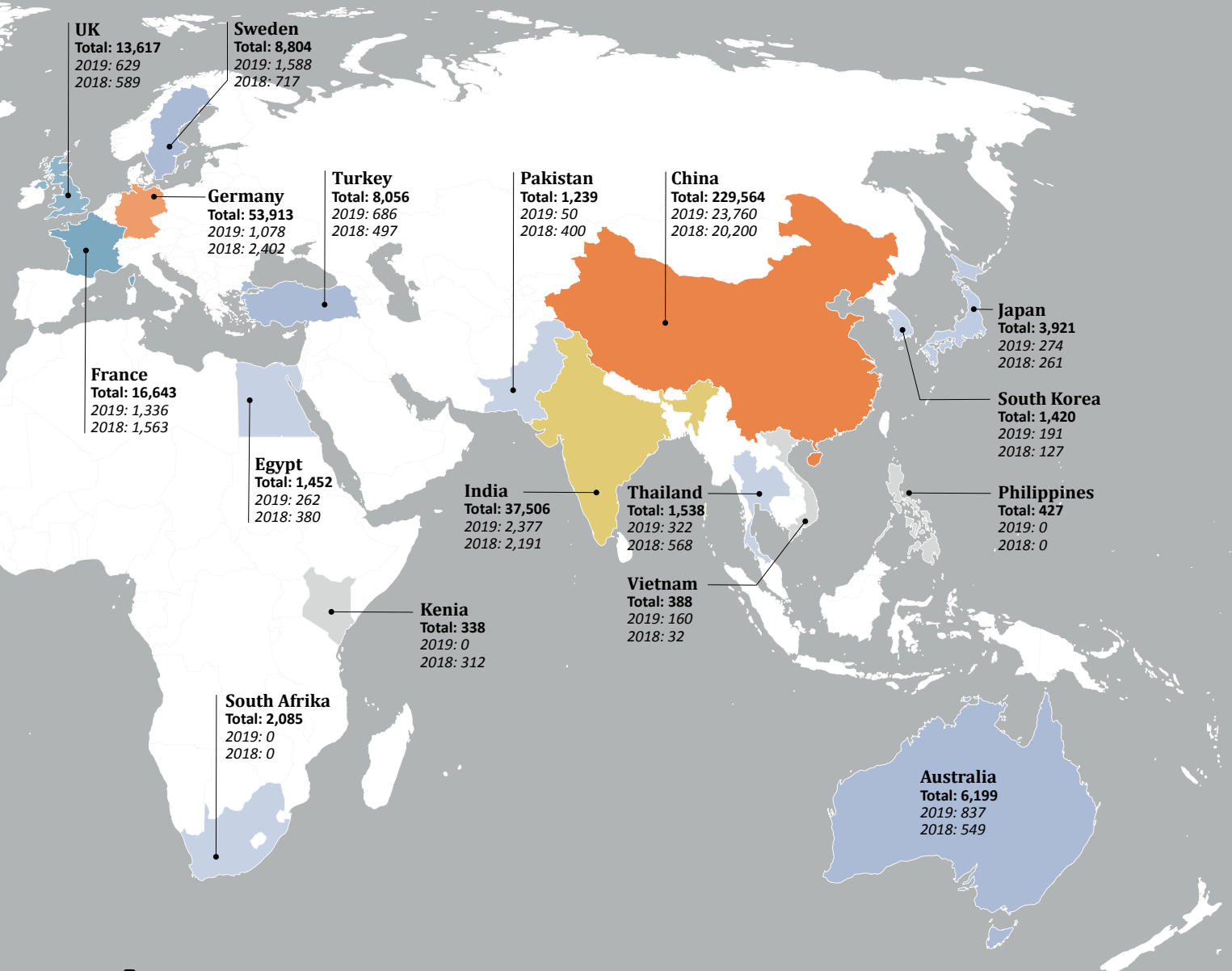

A strong year

Europe, North America and China – these are the markets that drove onshore wind expansion in 2019, achieving a total additional capacity of **54.2 gigawatts**. Despite the global uncertainty due to COVID-19, 2020 is set to be an absolute record breaker.

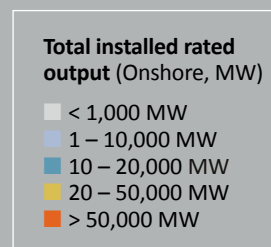

THE LABOUR MARKET

The number of jobs continues to decline

Despite the fact that the employment potential is enormous, ever more people in the wind industry are losing their jobs. Companies within the industry partially blame the German Federal Government and the current tendering system for this.

The drastic slump in the construction of new wind turbines in Germany in recent years (see p. 14) is having an ongoing negative impact on the labour market. According to the Bundesverband WindEnergie (BWE), whilst the wind industry employed 160,200 people in 2016 (133,000 onshore and 27,000 offshore), this number had already fallen to 135,100 in 2017 (112,100 onshore and 23,000 offshore). Officially, more up-to-date figures are not yet available, however the BWE expects further job cuts within the

industry due to falling installation figures. Since the introduction of tenders in 2017, there have also been enormous cost and competition pressures within the market.

Plant manufacturer Enercon announced further major job cuts at the end of 2019: over 3000 jobs, mostly among suppliers, are to be cut by the end of 2020. According to media reports, further job losses have not been ruled out. The company had already shed over 800 jobs by 2018. In September 2019, Vestas also

announced their intention to cut 590 jobs, over 500 of which will be in the rotor blade production sector in Lauchhammer, Brandenburg. They had already announced their intention to lay off 400 employees in Denmark and Germany a year earlier. The situation is once again worsening due to the Covid-19 pandemic: a further 400 workers in Denmark are currently facing redundancy. Nordex and Siemens Gamesa were also forced to cut jobs and, in April 2019, Senvion even had to file for insolvency.

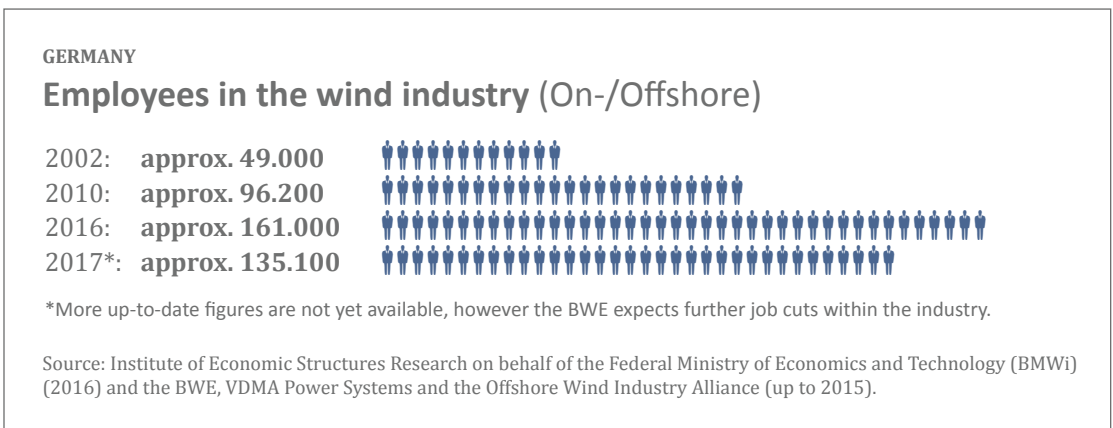

Erection of a Siemens Wind Power SWT 6.0 154 turbine. With a blade length of 75 m, this is the longest rotor blade in the world being installed here.
 Photo: Paul-Langrock.de





Wind farm near Prenzlau, Germany. Photo: Paul-Langrock.de

IG Metall: A bleak outlook

According to a survey of works councils conducted by the IG Metall trade union last year, a quarter of those surveyed expected further staff reductions by the end of 2019. 74.1 percent of them also expect a negative development in the German business sector going forward. Over half the works councils also report difficulties in finding suitable candidates to fill vacancies. According to a written statement by IG Metall, among other things, this is also due to the fact that “the wind industry often only makes the headlines for negative reasons”. As a result, 43 percent of the relevant companies are considering relocating their production abroad, where economic development is regarded as more positive compared with the German market.



43 %
of the relevant companies
are considering relocating
their production abroad.

Meinhard Geiken, then district manager of IG Metall Küste, characterised this clear trend as “alarming” and points out that: “We have already lost thousands of jobs in the wind industry. If politicians and companies fail to implement swift countermeasures, the industry will suffer

the same fate as the solar industry, which, with the exception of a few companies, has disappeared from Germany”. The vast majority (over 96 percent) of the works councils surveyed criticised the fact that there is little or no federal government support for the wind industry. 89 percent think that the tendering system will have “no or only minor positive effects”. “The works councils”, the trade union warns, “view tenders as a major source of increased cost pressure, often to the detriment of the employees”.

There was still no sign that things were easing within the German wind industry in 2020. On the contrary: the Covid-19 pandemic is causing additional problems. However, it has not yet proved possible to predict how the virus will affect the wind energy employment market.

THE WETIX MOOD BAROMETER

A positive long-term assessment for the international wind industry

The **WindEnergy trend:index** (WEtix) has become established as an important mood barometer within the wind energy sector since 2018. Almost 7,000 stakeholders have already taken part in the biannual survey conducted by the wind:research trend and market research institute in collaboration with WindEnergy Hamburg.

Since 2018, the WindEnergy trend-index (WEtix) mood barometer survey has been conducted every six months by WindEnergy Hamburg, the world's leading trade fair for on- and offshore wind energy, in collaboration with wind:research, the leading market research institute for the wind energy sector. The results are analysed and interpreted by wind:research based on know-how gained in various national

and international projects. WEtix asks the participants for their assessment of the current and future on- and offshore wind industry market situation as well as the potential of new technologies and digitalisation. Whilst the mood barometer asks the same questions in each survey round, it is supplemented by additional questions as required based on ongoing market observations, for example on the subject of hydrogen.

The wind energy barometer is highly representative

Both wind:research and WindEnergy Hamburg use their broad network within the industry to address the market participants: over 1,000 stakeholders have already participated in the WEtix online surveys, which means that more than 6,000 industry representatives have already participated in the surveys during

The mood barometer in detail

Survey period	Total participants	Survey completed	Completion rate
1. Survey Q2 2018	1,187	674	57 %
2. Survey Q4 2018	1,655	958	58 %
3. Survey Q2 2019	1,254	817	65 %
4. Survey Q4 2019	1,026	712	70 %
5. Survey Q2 2020	1,156	782	68 %
6. Survey Q4 2020 (As of: 22 September 2020)	1,007	684	68 %
Total	7,285	4,627	64 %

Source: WindEnergy trend:index (WEtix)

How would you assess the global market for the onshore wind industry this year?

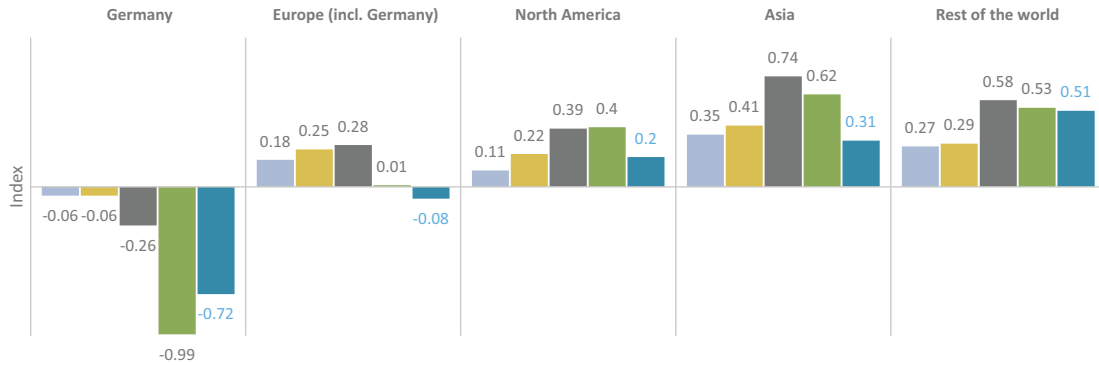

How would you assess the global market for the onshore wind industry over the next two years?

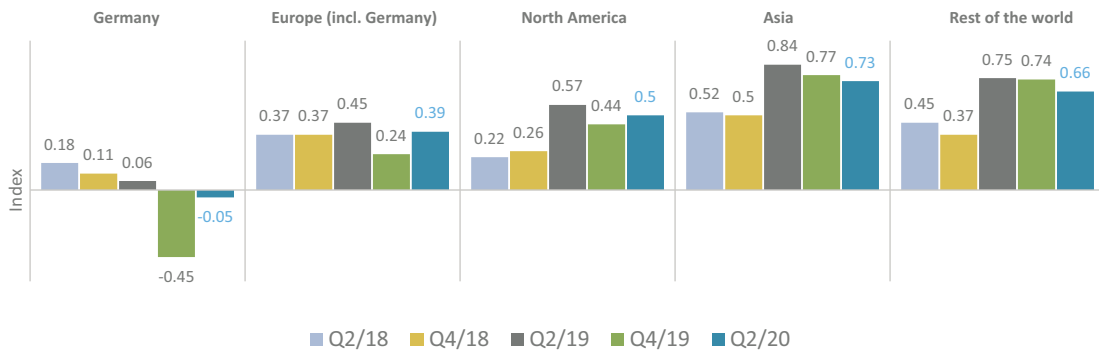

the five survey periods. This has enabled WETix to become established as an important wind industry mood barometer during the past two years, a fact which is also reflected in media coverage of WETix; both national and international newspapers, trade journals or online media report the results and discuss their significance for the industry’s further development.

The surveys are characterised by a high degree of representativeness: the responses are spread broadly across different countries and represent the respective market sizes, including the on- and offshore split. On average, more than 70 % and over 95 % of the market participants surveyed are active in the

German and European markets, respectively. A third of the respondents also focus on the Asian and North American markets, respectively.

The international market situation: mood currently sinking, but positive long-term assessment

The current mood in the international wind market has received a positive assessment for almost every region surveyed – Europe, North America, Asia, and the rest of the world – since 2018. However, the upward trend of the first three surveys (or four for offshore wind energy), has now come to a standstill: in the last two surveys, the current market situation values for the onshore wind

industry sank for Europe, North America, Asia and the rest of the world. The offshore wind energy market, for which the overall assessment continues to be very positive, also saw a decline in the last WETix (5th survey). However, the long-term trend forecast for both the on- and offshore wind industry was still positive to very positive in all regions.

“Problem child” Germany: neutral to negative values in almost all surveys since 2018

Ever since the surveys began in 2018, the German market situation has received neutral to negative values and is performing poorly compared to the other world regions. In particular, the market

estimates for onshore wind energy plunged well into the negative zone. The lowest values were reached in November 2019, when the negative mood more than tripled compared to the previous survey. In the last WETix in spring 2020, the negative trend of the past two years was halted, at least for the time being. Whilst the current mood within the market was once again viewed in somewhat more optimistic terms, the survey participants assessed the development of the onshore

industry as neutral and the offshore industry as slightly positive over the coming two years.

Future opportunities through new technologies and green hydrogen

The possibility of potential savings through the use of new technologies, such as larger turbines or floating foundations, has been rated as medium to high since the WETix was launched. With

regard to the potential of green hydrogen, over half of the respondents in the spring 2020 survey estimated the probability as high to very high that production will play a major role for wind energy over the next three years.

Information about WETix and wind:research can be found at www.windresearch.de.

How would you assess the global market for the *offshore* wind industry this year?

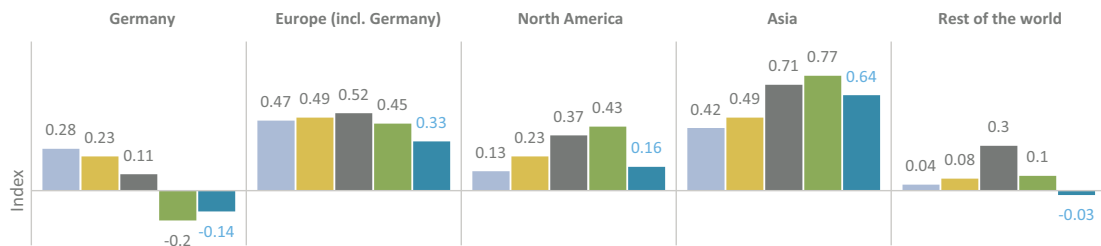

How would you assess the global market for the *offshore* wind industry over the next two years?

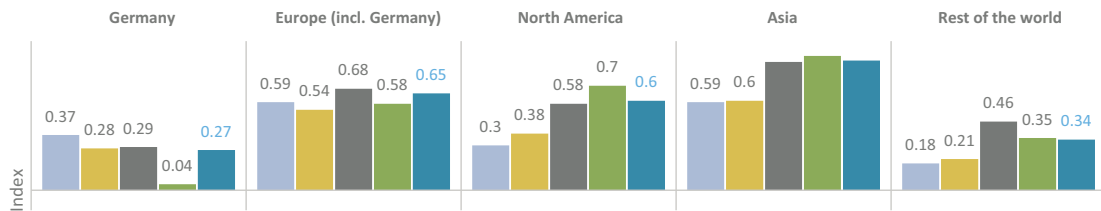

How would you assess the potential for further savings through technology (e.g., larger turbines, floating foundations)?

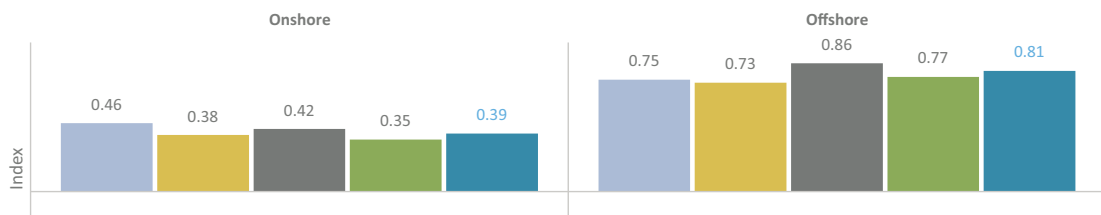

Source: WindEnergy trend:index (WETix)

■ Q2/18 ■ Q4/18 ■ Q2/19 ■ Q4/19 ■ Q2/20

OFFSHORE

Limited expansion, positive outlook

Very few new turbines had been built off the German coast by mid-2020. However, the German government has increased the expansion targets for 2030 and 2040. The production of green hydrogen could provide a further boost for the industry.



Only 32 new wind turbines in the North Sea and Baltic Sea with a total rated output of 219 megawatts (MW) were connected to the German grid in the first half of 2020. As of 30th June, this increased the total rated output of the now 1501 turbines to 7760 MW according to Deutsche Windguard. For comparison: 160 turbines with a total rated output of 1111 MW went online in 2019; in 2018 it was 136 turbines with a total rated output of 969 MW. According to WindGuard analysis, only 15 of the 32 new turbines (101 MW) were erected in the current year; the others had already been erected in the previous year. In addition, no new foundations for future turbines were installed in the first half of 2020. With the newly built facilities, the German government's expansion target had already been met in the first half of the year.

According to industry organisations German Wind Energy Association (BWE), the Federal Association of Offshore Wind Farm Operators (BWO), the German Engineering Federation VDMA Power Systems, the sector network WAB and the Offshore Wind Energy Foundation: "For a long time



497 MW
The total rated output of Germany's currently largest offshore wind farm "Hohe See" (North Sea).

we have been warning that an expansion gap is imminent, not least because of the long lead time for offshore wind farms. Now we are in the middle of it. The current challenge is to keep this expansion gap as short as possible and to strengthen the domestic market for offshore wind energy in a sustainable and permanent manner". They demand an economically efficient remuneration system for future offshore projects in addition to the fastest possible tender process for the available areas.



A day at Nordsee One wind farm draws to a close. The technicians are waiting for the WINDEA Four to take them back to the shore at Norddeich. Photo: Ulrich Mertens

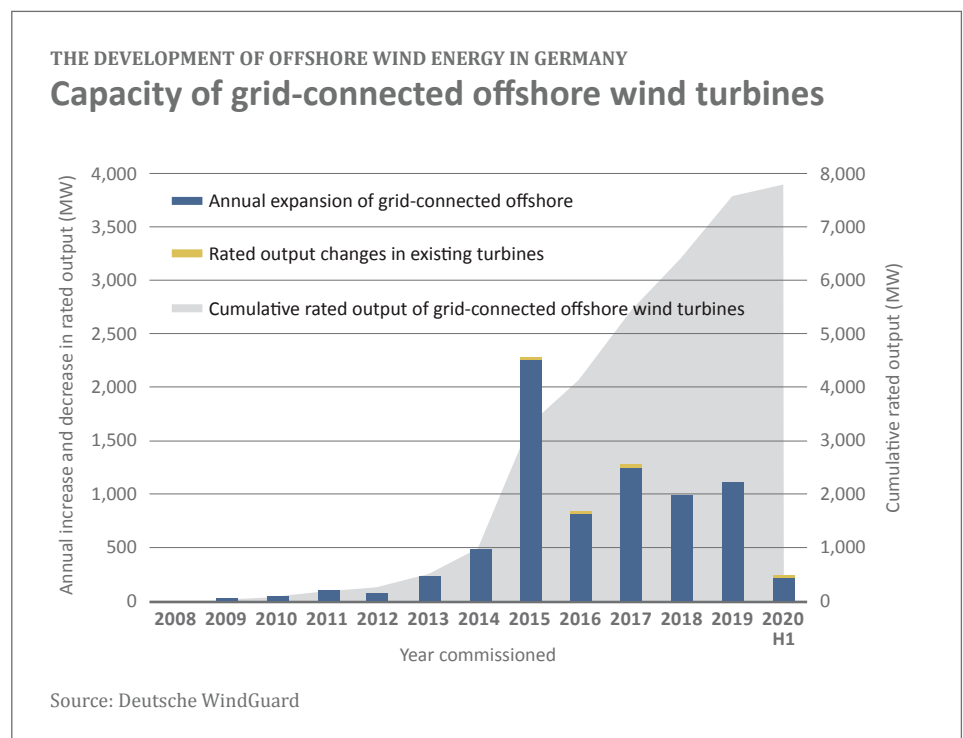



Service work at Nordsee One wind farm. Material is hoisted from the WINDEA Four to the work platform. Photo: Ulrich Mertens

Industry representatives: pro stakeholder diversity, contra speculative bidding

Criticism is being levelled at the German government’s planned design of tenders for the construction of new wind farms. Because bids of 0 cents to remunerate a kilowatt hour of electricity were received in the past, there will now be a so-called second bid component, whereby the Federal Network Agency will determine the willingness of 0-cent bidders to pay an offshore grid connection fee to be paid to the transmission system operator responsible for the connection. The government hopes that this process will reduce the cost of electricity and lead to a greater market integration of offshore wind energy. However, industry associations and the five northern German states fear that this will increase the cost of electricity generation and put stakeholder diversity at risk. As the Association of Municipal Enterprises (Verband der kommunalen Unternehmen) explains, the procedure “continues to generate speculative bidding, in which only major stakeholders can engage”. Opponents of the model advocate an alternative differential model, which would guarantee a minimum electricity price. If a certain price is exceeded, the excess proceeds would be paid back into the EEG account.

Despite these uncertainties, the industry can see the future in a positive light. In early June the Federal government passed an amendment to the Windenergie-auf-See-Gesetz (WindSeeG - Wind Energy at Sea Act), which envisages that the expansion target for offshore wind energy will be increased to 20 gigawatts (GW) by 2030; the target to date has been 15 GW. The intention is to have installed 40 GW by 2040. The offshore wind sector had long been calling for an increase to the target. In a statement, industry representatives said: “We welcome the fact that setting a target of 20 GW for offshore wind energy by 2030 and 40 GW by 2040 creates long-term planning security, particularly given the low level of new construction projects. The increased expansion targets mean that offshore wind energy will boost climate protection and lead to economic development”.

The government’s National Hydrogen Strategy (NWS) could provide an additional boost, as it requires significantly higher amounts of green electricity. “The NWS presents the opportunity to use about 3 GW of offshore wind energy for the production of green hydrogen. To this end”, the aforementioned organisations demand, “additional areas must be made available and put out to tender as quickly as possible. A system of incentives which includes efficient tax and levy mechanisms must be developed” for a rapid ramp-up of the market for green hydrogen.

As the Global Wind Energy Council (GWEC), the umbrella organisation of the industry, outlined in its Global Wind Report, at over 6 GW of new installations internationally, 2019 was the best year ever for the offshore wind industry. China and the United Kingdom led the way with 2,395 MW and 1,764 MW, followed by Germany in third place.

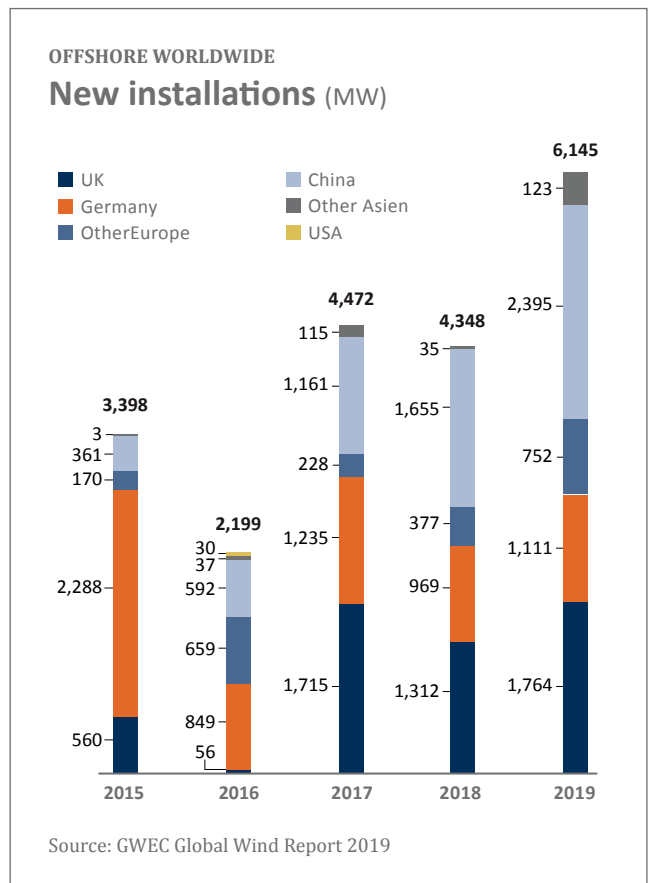

PLANT ENGINEERING

Front runner dethroned, turbines continue to grow in size

Enercon had to surrender the forerunner position in the construction of new onshore wind turbines in Germany to Vestas for the first time in 2019. In today's still tense market situation, manufacturers are continuing to focus on efficiency through larger rotors, taller towers and increased rated power output.

Wind turbine manufacturers have to assert themselves in a difficult market environment.

Cost and competitive pressure have increased enormously in recent years since the introduction of the tendering system and the heavy slump in the German market. The manufacturers are responding to this with increasingly larger, more powerful, and more efficient machines as well as cost-optimised design based on modularisation and standardisation, which increases yields as well as enabling the turbines to be operated at less windy locations.

This development has been confirmed in an analysis by the consultancy firm Deutsche WindGuard, according to which, the average capacity of turbines erected in Germany in 2019 rose to 3.32 megawatts (MW), which is 3 percent higher than in 2018. The average rotor blade diameter was 119 meters, representing an increase of 2 percent over the previous year. The hub height (2019: 133 meters) and total height (193 meters) each increased by 1 percent. According to an expansion analysis carried out by the association Windenergie an Land (FA Wind), 14 percent of the turbines installed in 2019 have a rated output of over 4 MW, whereas in 2018 it was 15 percent. Two thirds of new turbines have a rated output of 3–4 MW.

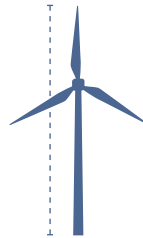

193 m

The average height of newly installed turbines (including rotor blades).

The leading plant manufacturers were able to expand their market positions in 2019. According to FA Wind, 85 percent of all newly erected turbines were manufactured by **Vestas** (119 turbines), **Enercon** (94) and **Nordex** (28). "Last year", according to FA Wind, "the Danish firm Vestas took the lead for the first time with a 44 percent market share, a gain of 18 percentage points compared with the two previous years, whereas the long-time leader Enercon, from Aurich, Germany suffered a significant market share loss." While in 2018 every second new turbine erected in this country was still from



Nordex Delta4000 platform in the Heubusch wind farm near Meerhof, Germany. Photo: Ulrich Mertens

PLANT ENGINEERING

Turbine types frequently put into operation in 2019

Manufacturer	Turbine type	Number
Vestas	V126	39
Vestas	V136	38
Enercon	E-115	29
Enercon	E-141 EP4	28
Vestas	V117	22
Nordex	N131	13
Nordex	N117	13
Vestas	V112	13
Enercon	E-92	13
GE Wind Energy	GE 3.6-137	12

Source: BNetzA, FA Wind (2020): Analysis of onshore wind energy expansion in 2019

Enercon, in 2019, it was only every third new installation. **Nordex** improved by one percentage point compared with 2018. The only manufacturer that built more turbines (16) in Germany last year than in the previous year (6) was **GE**. **Senvion's** share has halved to just 3.5 percent (11 turbines) due to insolvency. Trailing the field are **Eno Energy** (9) and **Siemens Gamesa** (5)¹.

Manufacturers focus on efficiency optimisation

To continue to survive in the market, **Vestas** are currently putting their focus on the so-called EnVentus platform which includes the models V150-5.6 MW and V162-5.6 MW. The intention is to use the platform architecture as the basis for new turbine variants. As stated on the company's homepage, "the result is one versatile platform architecture that

delivers a higher level of robustness and performance with the ability to create an even more finely matched combination of turbines to harness available wind energy in any specific location." Vestas also continues to place its trust in various versions of the proven 4 MW platform.



119 m
Average rotor blade diameter of newly installed turbines.

¹—Source: FA Wind (2020): Expansion analysis by Windenergie an Land in 2019.

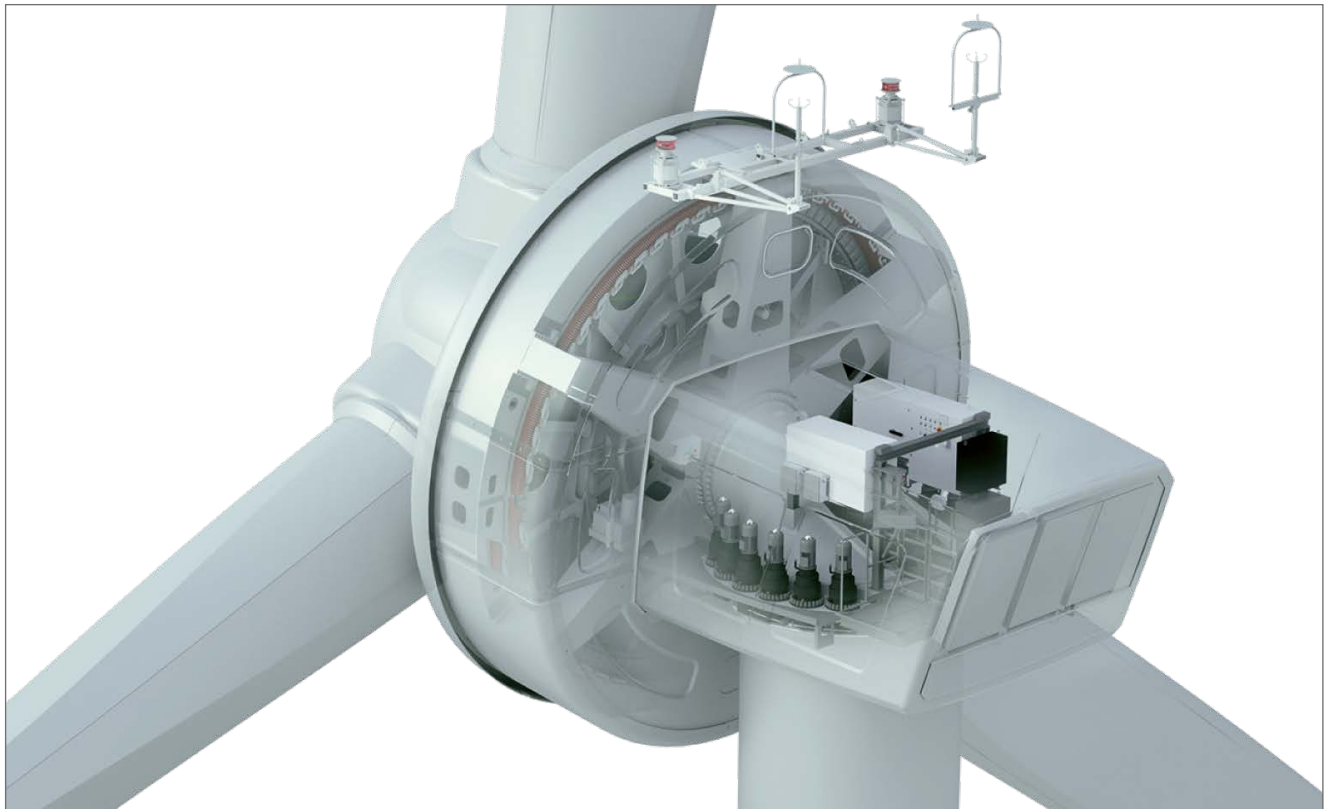

Enercon's flagship – the E-138 EP3 model. Graphic: Enercon



Transporting a 73.3 m long rotor blade for a Vestas V150-4.2 MW to Keula wind farm in Thuringia. Photo: Jan Oelker



133 m

The average hub height of the newly installed turbines.

Enercon’s current flagship products are the E-136 EP5 and E-138 EP3 models. The first number stands for the rotor diameter; both are available in different hub heights. Whilst the EP5 has a rated output of 4.6 MW, the EP3 has a rated output of 3.5 to 4.2 MW, depending on the construction type, and is designed for low wind speeds. Enercon describes the EP3 series as efficient turbines “that comply

with the requirements of a renewable energy system and meet the demands of competitive markets”. The company also produces EP1 and EP2-class models.

In addition to their proven AW3000 platform, **Nordex** is now producing the Delta4000. “With the N149/4.0-4.5”, the company states on its homepage,

“the Nordex Group was the first company to launch a turbine with a flexible rating as part of its core design philosophy and operation strategy. This design approach, combined with a variety of operating modes, makes it possible to adapt each Delta4000 to the grid operator’s individual requirements, local wind conditions and noise restrictions”.

PLANT ENGINEERING		
Average turbine configuration		
Average turbine configuration	New installations in 2019	Change compared to previous year
Rated output	3.317 kW	+3 %
Rotor diameter	119 m	+2 %
Hub height	133 m	+1 %
Total height	193 m	+1 %
Specific ground coverage	302 W/m ²	0 %

Source: Deutsche WindGuard: Status of onshore wind energy expansion in Germany in 2019.

Question #3: “What has been your most important strategic decision within the last two years?”



“For Gram & Juhl it has proven of the past years to combine a very solid ground of experience in our industry with new technologies and approaches – a path to follow. We have taken major steps towards software as a service. During the last two years we have worked on developing cloud solutions and investigated further into how machine learning can be used for our purpose.”

ZABIHULLAH ALEFI, COO/Head of Monitoring, Gram & Juhl GmbH



“One of the most important strategic decisions of the last two years was building up internal knowledge in order to be able to carry out all service work on Senvion 3X products. In addition, more site managers have been trained, so that with these additional site managers we are even better positioned to take on complex projects / main component replacements even more promptly and flexible than in the past.”

SARAH SCHWAB, Managing Director, Connected Wind Services Deutschland GmbH

“The consistent implementation of modifications and upgrades, in order to increase the operational capability and gearbox life expectancy, under consideration of technical and economical aspects“

ACHIM OEBEL, General Manager and Shareholder, Multigear GmbH



“What we have learned over recent years is that we need to be involved locally, that it is important to include residents and to give them more opportunities.”

HEINRICH LOHMANN, Founder and CEO of the MLK Group



“Nölting GmbH has internationalized its network of contacts and developed digital marketing formats in order to emotionalize companies from the renewable energies with moving marketing brands and services.”

VINCENT NÖLTING, Managing Director, Nölting GmbH – EXPERTEN FÜR VERTRIEBSUNTERSTÜTZENDE KOMMUNIKATION



“PNE, as one of the most experienced wind farm developers, now develops into a “Clean Energy Solutions Provider”. We provide solutions for renewable energy projects - regionally, nationally and internationally. In addition to wind, we are developing photovoltaics, power-to-X like hydrogen and services.“

MARKUS LESSER, CEO,
PNE AG



“To no longer align our growth strategy to geographic markets but to our customer’s targets – and thus exploit Ramboll’s global presence and broad expertise“

JOACHIM BINOTSCH, Business Development Manager
Onshore Wind, Ramboll



“According to our holistic advice, we see wind energy more and more as a component within the sector coupling. This requires more complex solutions, for example in the production of green hydrogen, in order to further strengthen the role of renewable energy.“

STEFFEN KÖLLN, Managing Director,
Sterr-Kölln & Partner mbB



“Elpress focuses on nature’s own energy resources and supports the technology for harvesting these for a better and cleaner environment with Wind turbines and Solar power energy sources. We contribute to the industry and the OEMs with more than 60 years of knowledge with complete crimping systems. We design, develop, invent prototypes, test and validate new products according to the highest requirements and tests on the market. In the last 2 years our product series of bi-metallic connectors has been one of the market leader within the majority of the wind turbine manufacture due to the high quality and reliability for long term use. Together with our patented dual crimp technique this ensures a safe and reliable connection.“

HENRIK HØJ RASMUSSEN, Key Account Manager,
ELPRESS GmbH



“An important decision was to bring know-how and decades of experience in sealing technology for large and heavy machine construction into the challenging growth market of wind energy.“

DIPL.-ING. DIETMAR WOYCINIUK, Managing Director,
TECHNO-PARTS GmbH



DIGITALISATION

Artificial intelligence for the wind industry

Digitalisation is becoming increasingly important for the operation of wind turbines. The use of artificial intelligence is opening up additional ways to reduce costs and avoid downtime.

Digitalisation is also making inroads into the wind energy sector.

People in the industry are continuously working on new and innovative ideas to save time and money. Applications range from sensors that monitor the condition of individual turbine components and sound the alarm even before a defect occurs, thus preventing a worse outcome, to drones that fly autonomously through the wind farm inspecting rotor blades for damage, to wind and yield forecasts and electricity demand predictions.

The PiB research project

There is a drive to collect as much data as possible whilst the turbine is operating and to evaluate and use it intelligently. So-called artificial intelligence (AI) is increasingly being used, and not only for predictive maintenance purposes. One example is the University of Bremen's Predictive Intelligent Operation Management to Reduce the Icing Risk of Wind Turbines (PiB) research project, which began in January 2018 and is scheduled to run for three years. Project partners include Energy &

Meteo Systems, a forecasting service provider, the engineering firm Spitzner Engineers and wpd Windmanager.

The project is aimed at reducing downtime in winter due to ice formation on rotor blades as well as the prevention of ice damage, to which end, according to the project description, "a completely new concept for anti-icing systems" is to be developed. "Rather than waiting for the ice report from the sensors installed on the turbines" the aim, going forward, is to make it possible to predict the specific icing risk for each turbine. Wind farm operators should get advance warning of when an ice front is approaching and be able to start the blade heaters accordingly. The intention is to reduce costly downtime, protect materials and prevent damage. Personnel costs could also be reduced, because service teams sometimes have to be deployed before frozen equipment can be re-started.

◀ Autonomously flying drone in wind farm. Photo: Sulzer & Schmid

Rotor blade inspection by drone. Photo: Aero Enterprise





Ice on the rotor of an Enercon E-40 at Breitenau wind farm. Photo: Jan Oelker

Over 20 years' worth of sensor data from 3000 individual turbines from over 20 years –supplied by wpd Windmanager– and meteorological data provided by Energy & Meteo Systems will be evaluated and correlated for use in the underlying forecast model. “To do this”, the project partners explain, “the team will be using data mining technologies, because it would take years or even decades to manually sort and analyse all the data. A range of AI-based methods, such as correlation processes, pattern recognition and neural networks, will be used. By the end of the project there will be a prediction prototype, which is planned to be tested in the winter of 2021. The researchers would then like to be able to derive recommendations for wind farm operators from the data, which could be integrated into a wind farm's operational management software at some point in the future. The researchers predict that wind farms could even communicate with one another in future to warn each other of icy spells.

AI is also used in other applications such as in autonomous drones that inspect rotor blades for damage. AI elements are used by the associated analysis software to identify and categorise defects.

“AI will optimise yields”



HOLGER FRITSCH

Managing Director of Bachmann Monitoring GmbH, shares his thoughts on Artificial Intelligence (AI)

Mr. Fritsch, many marketing departments like to use “AI” as a buzzword. What is real AI and what is hype?

I absolutely understand that marketing departments, and they are not the only ones, like to use the term “AI” to boost their image. This is fine from my perspective, as long as it refers to a global and, as yet, future goal.

Experts are well aware that all current methods of data analysis represent weak forms of AI. Although analysis can be automated, data itself must still be carefully prepared, otherwise it cannot be processed. If this prerequisite is ignored, then data analysis too often becomes a question of “garbage in: garbage out”.

In terms of the wind industry, where and how can AI help improve forecasts and increase yields today?

Even the weak AI models currently available can help tap into considerable potential to optimise operational management (yield optimisation). Still, companies must recognise that the “AI” buzzword cannot remedy structural or entrepreneurial deficits. One essential prerequisite for its successful use, for example, is standardisation.

And where is this all heading?

AI cannot be left only in the hands of mathematicians. On the one hand, it is a question of extensive standardisation, for example through the introduction of RDS-PP (optimisation of wind turbine service). On the other hand, AI must be linked with real life experience from turbine operations. This is the only way to ensure that turbine operations will continue to be profitable in the future. We will be launching further pilot projects in this area next year.

Question #4: “What has been the most important **innovation** in your industry in the last two years and why?”



“Through our cooperation with a well-known vehicle manufacturer HAWART has developed, constructed and manufactured a hydraulic lifting adapter. This new product is a suitable component for transporting large and very long rotor blades by road. Our lifting adapter connects the vehicle to the flange area of the rotor blade. In combination with the self-steering trailer made by DOLL rotor blades are safely transported by land. As an additional feature, a so-called tandem frame was developed on the trailer that carries the rotor blade in two tip frames. We are pleased that several customers have now used this transportation concept.”

DIPL. ING. WILLY B. KÖRNER, CEO,
HAWART Sondermaschinenbau GmbH



“Fail-safe operation of the wind turbine requires knowledge of all construction activities in the park and line connection area. The wind farm operator benefits from the high number of requests via the cross-divisional BIL community portal.”

JENS FOCKE, Chairman of the Board,
BIL eG



“The most important development is the development of Na-NiCl batteries, as the cost is 50 percent lower than with lithium battery cells. Raw materials for this are well available. The battery can be scaled as desired.”

MICHAEL WAHL, Managing Director,
GAIA mbH



“Market and system integration via virtual power plants is the basis for a continued deployment of renewable energies and sector coupling.”

JOSEF WERUM, Proprietor, Managing Director, and
Founder, in.power GmbH



“For our company that would be the continuous development of the SPMT (self-propelled modular transporter) in combination with the bladelifter. This allows us a transportation of the blades through forests or small villages without the need to fell trees or widen roads. It results in a significant cost saving and at the same time represents a more sustainable solution.”

BIRGIT STEIL, Managing Director,
STEIL KRANARBEITEN GMBH & CO. KG



Participation by local residents can also be innovative. The MLK Group's innovative wind farm project is described on p.66. Photo: Delabar/REZ

DRIVERS OF INNOVATION:

Companies with innovative projects

The following pages are dedicated to companies whose new products, processes or methods ensure the continued development of the wind industry. Use the opportunity to get in touch with them and benefit from their innovation.



FORERUNNER FOR YIELD- AND COST-OPTIMISED TURBINE GENERATIONS

ENERCON's new top model E-160 EP5 with permanent magnet generator technology marks the company's entry into the **large rotor class**. ENERCON is developing further turbine types based on it that take account of the increasing cost of energy demands.

ENERCON's new E-160 EP5 turbine type is an important cornerstone of our new product and marketing strategy with which the company intends to win an even greater share of the international market going forward. Many of the currently planned projects around the world are based on this new turbine, which is ENERCON's new top model with the largest rotor diameter in our entire product range – the low wind version of our EP5 platform, which also includes the E-147 EP5 for sites with medium wind speeds and the E-136 EP5 for sites with strong wind speeds. The prototype was installed at the Wieringermeer wind power test site in the Netherlands in July 2020.

The E-160 EP5 prototype, which has a rated power output of 4.6 MW was erected at the test site on a modular steel tower (MST tower) with a hub height of 120 meters. One of the special challenges involved in the installation of the first E-160 EP5 was transporting and handling the rotor blades, which at 78.3 metres, are currently the longest components in ENERCON's portfolio. A new logistics concept was therefore devised in collaboration with the transport service provider, which included trial loading and test drives with the planned transport equipment and a detailed route survey to prepare the direct run of the prototype components from the factory to the



Prototype of the E-160 EP5 in the Wieringermeer wind energy test field in the Netherlands
Photo: Klaas Eissens

construction site in an optimum manner. The Blade Hoisting Device used for single-blade assembly, which is a special mounting device for the rotor blade to be assembled and is attached to the crane hook together with the clamped blade, was also new for ENERCON, as was the Hub Rotating Tool, an assembly tool adapted to the EP5 turbine type for rotating the rotor head during blade assembly.

Meanwhile, WRD, ENERCON's research and development company continues to work flat out on the EP5 programme. "The prototype", ENERCON CTO Jörg Scholle explains, "as constructed in Wieringermeer corresponds to the E1 version". For us, the E1 with its nominal power rating of 4.6 MW represents an initial foray into the large rotor class with permanent magnet generator technology. We're using this variant to validate the technological concept and to measure the turbine under practical conditions. At the same time, the E1 gives us the basis for the development of further variants with higher nominal and rated power outputs".

„The E2 is ENERCON’s answer to our customers’ the ever increasing ‘Cost of Energy’ requirements. Cost pressure is now a determining factor for wind turbine technology in all market regions around the world. Wherever we are, we must submit to the CoE Dictum“

Jörg Scholle, CTO, ENERCON.

This product strategy, which takes ENERCON’s striving for lower “cost of energy” values into account, will take concrete shape in the next step in the form of the previously announced E-160 EP5 E2. The E2 is the next evolutionary step of the E-160 EP5 and provides a significant increase in performance with a rated output of 5.5 MW. At locations with annual average wind speeds of 7.5 m/s at hub height, it will produce more than 21,534 megawatt hours (MWh) per annum. This is an increase of about 9 per cent compared with the E1, which produces about 19,615 MWh per year at the same location.



Cost-optimised rotor hub. Photo: Klaas Eissens

Rough modification history of the EP5 wind turbines:

	LP4 PMG LP4 nacelle TBP / TBM	HP PMG EP5 nacelle TBM	HP+ PMG EP5 nacelle TBM	E-Nacelle
E-136 EP5 4.65 MW	E1			
E-147 EP5 E1: 4.3 MW E2: 5.0 MW	E1	E2		
E-160 EP5 E1: 4.6 MW E2: 5.5 MW E3: 5.56 MW		E1	E2	E3

The developers also have ideas in hand for the post-E2 era. “In terms of research and development”, says Jörg Scholle, “we’re continuously striving to further optimise and simplify turbine design as well as production, transportation and assembly processes with a view to contributing to a further reduction in ‘Cost of Energy’ values. The same applies to the EP5, which is why we are already working on innovative solutions that go beyond the E2 development stage”.



New HP generator, new nacelle design (faster assembly; more common parts). Photo: Klaas Eissens

Project overview

Initiator	Enercon GmbH
Facts and figures	E-160 EP5 Nominal power: 4.6 MW Annual energy yield (average wind speed 7.5 m/s): 19,615 MWh Hub heights: 120 m, 166 m Rotor blade length: 78.3 meters Wind class: IEC IIIa Rotor diameter: 160 m Generator: Direct-drive permanent magnet generator (PMG)
Project status	Mechanical installation completed. Final commissioning at the Wieringermeer site is imminent. R&D measurements to begin subsequently.
Location	Wieringermeer, Netherlands



Are you interested in the project and want to know how your community or your business can benefit from it? Contact us. Our contact can be found in the [company profile on page 93](#) ▶

REDUCED-RADIATION OBSTACLE LIGHTS

To a large extent, public acceptance of wind energy depends on the aviation hazard lighting used. Wind energy in Germany can only expand if this aspect is taken into account

Acceptance by local residents has always been a central guiding principle for Lanthan in our developments and actions. Our successes include the introduction of visibility regulation and, earlier this year, the introduction of demand-controlled night-time marking using transponder technology (BNK). In areas where demand-controlled night-time marking cannot be used, reduced-radiation lighting represents a resident-friendly alternative.

Our “Aviation Regulation Conformal Surface Intensity Reduced Intelligent Lighting” (ARC-SIRIL) addresses our aforementioned guiding principle by means of a different operating principle.

The purpose of obstacle lights on wind turbines is to ensure aviation safety. The international requirements are defined by the ICAO and then specified in national guidelines by the respective states, in Germany, for example, in the Allgemeine

Verwaltungsvorschrift zur Kennzeichnung von Luftfahrthindernissen (General Administrative Regulation on the Marking of Aviation Obstacles).

Usually, the night-time marking of wind turbines involves the use of two medium-power hazard lights and four additional obstruction lights at one or more tower levels. Fire W red is used as a specific solution in both Germany and in some neighbouring countries. Whilst this

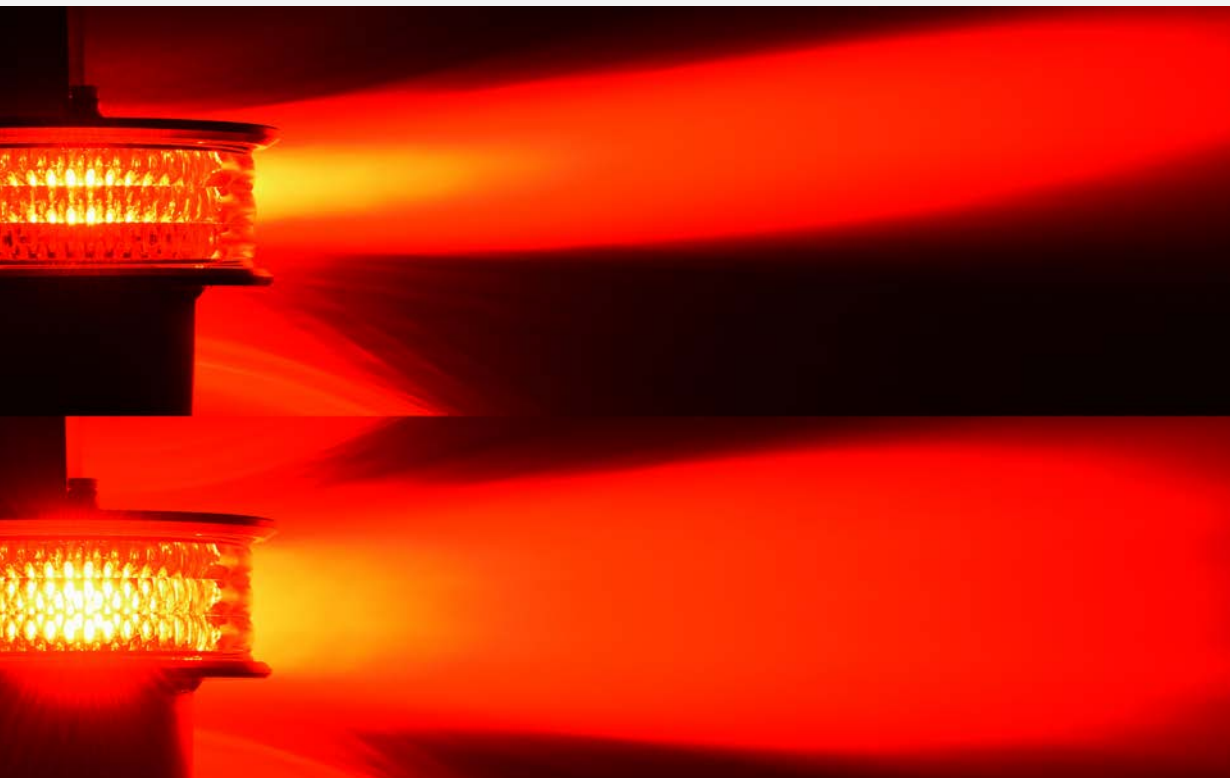

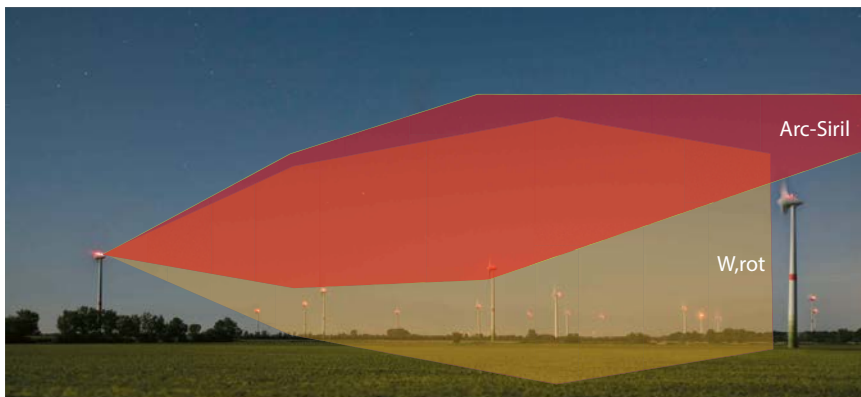

is a much lower intensity lighting system, it has a much greater radiation below the horizon and towards the ground.

To develop our ARC-SIRIL radiation-reduced solution, we first analysed the space to be illuminated. We then determined the optimum light emission based on the interaction between the nacelle and tower lighting. This enabled us to develop the following innovations:

- The navigation obstacle lighting system illuminates the relevant airspace.
- The safety-relevant luminosity of the lighting system is only visible by the pilot.
- Residents living near wind farms are screened from unnecessary light emissions.

Due to the reduced light immissions on the earth's surface during the evening and at night, the wind turbines become almost invisible during this period. The graphic above illustrates the mode of operation.

It is very clear that not only is there less overall immission on the earth's surface, but also that the emission angle does not cover the airspace most relevant to residents, represented here by houses. To residents, the obstruction lights are therefore almost invisible, which makes the flashing of the lights that is criticised by residents irrelevant. However, pilots can still see the wind turbines with unimpaired brightness even from a slightly elevated position.



Conclusion

Reduced-radiation lighting systems are a cost-effective and resident-friendly supplement to demand-controlled night-time marking, which can also be adapted to comply with other national guidelines. The system is installed on a single turbine at Bremer Kreuz and is currently being installed in wind farms in the Paderborn area.

Location Jakobistr. 25A, 28195 Bremen
 Tel.: +49 (0)421 696465-0
 Fax: +49 (0)421 696465-11
 E-Mail: info@lanthan.eu
 www.lanthan.eu



Are you interested in the project and want to know how your community or your business can benefit from it? Contact us. Our contact can be found in the [company profile on page 111](#) ►

BATTERY-POWERED TORQUE WRENCH MAD-S: INDUSTRY 4.0 AND 1 % ACCURACY

M-PT Matjeschk-PowerTools has developed a sensor-controlled battery torque wrench. Integrated into the worker guidance systems **ProTight™** and **BoltPilot®** the tool guarantees maximum process security.

Being the newest development in bolting systems on the market, the battery-powered MAD-S delivers maximum ergonomics, occupational safety and accuracy on all bolted connections in the wind industry. The torque sensor on the MAD-S is located at the gearbox output. Thanks to this unique design the torque accuracy remains unaffected by progressive wear on the gearbox. This is different compared to conventional sensor-controlled bolting tools, where the torque sensor is placed between the motor and the gearbox input. These tools will become less accurate the more they are used: worn gear parts or motor failure have an adverse influence on the bolting accuracy of these tools.

The MAD-S has an accuracy of $\pm 1,0\%$ in a torque range from 70–1.400Nm. More types of up to 7.000Nm are currently under development.



Certified Fastener Engineer (DSV)® Felix Hebestreit and hard-/software developer Peter Mirtschink at a bolt tightening analysis on field.

The benefits of the MAD-S

- Sensor-controlled torque shut-off via strain gauges positioned on gearbox output
- Sensor-controlled angle tightening
- Suitable for bolting according to VDI/VDE 2862-2 category A
- Digital setup menu
- Brushless electric motor
- Adjustable automatic load release
- Including Documentation System and Bolt Check Function

With the help of the Torque Check program, made by M-PT, the MAD-S battery-powered torque wrench is able to check bolted connections without turning the bolt. This prevents overtightening of bolts.



Sensor-controlled battery torque wrench series MAD-S.



Bolting in the worker guidance system ProTight™ with battery torque wrench MAD 20.

ProTight™ worker guidance system

The software on the MAD-S was programmed in cooperation with the development department of ProTight™, adhering to all criteria and requirements of this worker guidance system. ProTight™ software is mostly used by wind turbine manufacturers at their assembly workstations. Depending on the equipment, the bolting result will be visualized on signal lights as PASS or FAIL, or printed as a barcode and placed on the component. Furthermore, the bolting connections can be displayed on the monitor screen as a picture or a video. The ProTight™ software communicates with the bolting tool via Bluetooth and transmits all torque and angle values bolt by bolt.

BoltPilot® for use on site

For construction and maintenance of wind turbines, the sensor-controlled battery torque wrench MAD-S is also equipped with BoltPilot® software. All bolting processes will be documented and saved in the cloud with BoltPilot®. The assembly supervisor can check the recorded bolting values from any location. This facilitates the communication between the assembly supervisor and the technicians on site.

Conclusion

Thanks to the strain gauges being positioned on the gearbox output of the torque wrench an accuracy of $\pm 1,0\%$ is ensured. Progressive gear wear has no influence on the accuracy of the tool, as opposed to competitors' tools. Bolted connections are fastened securely and reproducibly. Wind turbine manufacturers and wind turbine service companies can demonstrate the torque results to their clients and to quality assurance, and if specified, proof that all bolts were fastened within the specified torque range.



Bolting of vertical flange in the tower with sensor-controlled battery torque wrench MAD 7-S.

Torque wrenches with ProTight™ at a glance

- Battery torque wrench MAD (30–7.000 Nm)
- Sensor-controlled battery torque wrench MAD-S (70–1.400 Nm)
- Electric torque wrench MED (65–11.000 Nm)
- Sensor-controlled electric torque wrench MED-S (65–11.000 Nm)
- Electric torque wrench E-RAD BLU (135–16.500 Nm)
- Sensor-controlled electric torque wrench E-RAD BLU-S (135–16.500 Nm)

Project overview

Initiator	M-PT Matjeschk-PowerTools GmbH & Co. KG
Implemented by	M-PT Matjeschk-PowerTools GmbH & Co. KG, De Jaeger Automation BVBA and Texas Controls S.L.
Facts and figures	Development and sale as well as rental of torque wrenches (battery, electric, pneumatic) and hydraulic bolting systems (hydraulic torque wrenches, tensioners and pumps). Repair and calibration of all torquing and clamping systems (also from other manufacturers).
Project status	On the market since April 2020.



Are you interested in the project and want to know how your community or your business can benefit from it? Contact us. Our contact can be found on page 250 ►

MOVING MARKETING – SALES ON THE MOVE

Moving marketing stands for the interactive exchange of knowledge and for **an integrated concept of digital communications**, whereby the recipient interacts rather than simply accepts information.

Moving Marketing Bewegungsbild in 2020

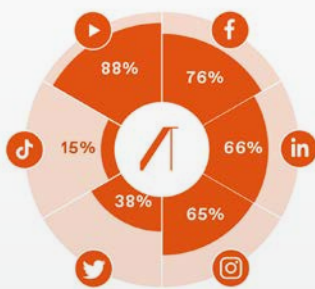

Kanäle



Technik

Marketing and sales – a single unit

Moving marketing brings marketing and sales even closer together. “Touting for business”, the well-known way of acquiring new customers, is proving to be increasingly labour-intensive and, from a marketing perspective, is quite wasteful. Moving marketing fundamentally changes the acquisition of new customers because it is all about “being found”!

Demand-oriented communications

Digital communication channels make it possible to address several target groups at once based on their specific requirements. SEO, SEA, and social media platforms all create high visibility with manageable budgets. At the same time, precise target group marketing can be implemented, and campaign success can be tracked down to the smallest detail. Because of the diversity of the target groups, addressing them can be a major challenge, especially for companies in the renewable energy sector. Nölting GmbH was able to analyse and evaluate this during the past 10 years whilst providing consultancy services to various companies within the sector.

Moving marketing specifically promotes user interactions with the medium, message and content whilst also bundling the most diverse digital social and information media into an overall concept. Gone are the days of boring newsletters with their one-way communications!

The *Moving Letter* provides for interaction between the target group and experts. The *Moving Magazine* makes the message and knowledge digitally tangible. Interactive modules are incorporated into corporate websites. Closely connecting corporate communication media with YouTube, Facebook, Instagram, or LinkedIn is becoming a powerful standard. The relevance of this type of content delivery has been confirmed not least by a Forbes study, which showed that 90 percent of executives in US American companies watch product-related videos on YouTube.



„Move out of your comfort zone“

Vincent Nölting

Moving Marketing Erfolg durch Bewegtbild



Design Communications

Design plays a significant role in *Moving Marketing* campaigns. It is no longer sufficient to transfer images and colour schemes into a design. What is required is the conceptual and technical ability to set corporate communications in motion, in order to provide the user with an experience whilst conveying brand content (UX).

Implementation and advantages

Moving Marketing combines user experience, moving images and design elements with corresponding text. In addition to the technically relevant aspects, fun plays an increasingly important role.

Thus far, technical products and services have mostly been described in a static fact-based manner. *Moving Marketing* provides the means to make complex and subject-specific content accessible to purchasers and decision-makers who lack the necessary technical expertise. A complicated specialist article is transformed into tangible knowledge transfer.

Moving Marketing thus boosts sales through a holistic digital approach and supports long-term success.

Project overview

Initiator	Nölting GmbH, marketing communications specialists
Implemented by	Nölting GmbH & Nölting Network



Want to include *Moving Marketing* into your sales and marketing communications? Get in touch. Our contact details are on page 178. ▶

Conclusion

***Moving Marketing* is the next generation in communications, enabling the varied renewable energy target group both to consume information and connect with it. It conveys emotions and values based on a uniform digital marketing concept.**

EFFICIENT ROTOR BLADE MONITORING

One challenge for wind turbine operators is having to continuously increase the efficiency of their wind turbines. The focus is on the rotor blades, which not only poses the greatest challenges but also offers opportunities.



In recent years, the rotor blade has clearly become the centre of attention in terms of the development of monitoring solutions for wind turbines. On the one hand, operators need to know about events that may damage the rotor blades. On the other, the measured data is increasingly being used for system control purposes. Ideally, therefore, a solution will be used in wind turbines that monitors different areas of the rotor blade and can be expanded in future.

Phoenix Contact Deutschland GmbH's Blade Intelligence system combines lightning measurement, ice detection and load monitoring processes, whereby the system is designed in such a way that operators can select only those functions that they actually need. If they wish to expand the system at a later date, they can do so easily.

“The ice sensors are attached to the rotor blade using adhesive film. They are equipped with a solar cell and memory, which means that they can work self-sufficiently for up to 1000 hours even in regions with less direct sunlight”.

*Oliver Pukall,
Renewable Energies Industry Manager*

Several configuration stages are available for the ice detection function: depending on the requirements and the regional situation, the operator can choose between a simple ice detection system which will stop the turbine when there is ice on the rotor blades or a restart procedure, which will automatically restart the wind turbine when the blades are ice free. The basic system can be upgraded to the restart solution at any time.

The LM-S lightning measurement system has already been installed in many wind turbines and enables the measurement of lightning strikes into rotor blade arresters. Valuable service information can be gained from the collected data and decisions made on the basis of it such as, for example, whether and when a blade needs a closer examination. So, blade maintenance can be better planned, and

the service technicians know what to expect on the wind turbine before they start work. The efficiency of the LM-S can be increased by combining it with other blade monitoring systems, such as load monitoring data, for example, which can identify changes related to the time of the lightning strike. Options such as these significantly improve the analytical possibilities in terms of remote monitoring.

Cost efficient strain gauges have been used to measure loads in wind turbine rotor blades for several years now, which is why Phoenix Contact has integrated them into a housing in such a way that they are robust enough for use in rotor blades even if they are not directly laminated during production. The advantage of this is that defective sensors can easily be replaced. The complete blade intelligence system can also be retrofitted as required.

As with the ice detection system, various upgrades are also available for the load measurement system. An additional inertia metering unit (IMU) in the blade or hub records further data concerning, for example, acceleration, rotation rate or temperature, all of which can be used to monitor the wind turbine.

Conclusion

Our Blade Intelligence System provides operators with greater transparency about rotor blade events such as lightning strikes, ice build-up or conspicuous loads, so they are always informed about the current status. This solution is not only suitable for new plants but can also be retrofitted in older wind turbines. By retrofitting the respective sensors, existing systems can be upgraded to the current state of the art to optimise their performance.

Project overview

Initiator	Phoenix Contact
Implemented by	Phoenix Contact Deutschland GmbH
Facts and figures	Blade Intelligence rotor blade monitoring system comprising lightning current measurement, ice detection and load monitoring
Project status	Development completed, commercially available
Location	The project is not site-specific. The system can be used throughout Germany.



Are you interested in the project and want to know how your community or your business can benefit from it? Contact us. Our contact can be found in the [company profile on page 118](#) ►

REPAIR AND PROTECTION WITH REWITEC

Increasing the service life and efficiency of wind turbine bearings and gears through innovative layer silicate-based additives for oils and greases

REWITEC technology-based product range.



The number of wind turbines worldwide has been increasing continuously for many years as has their rated output and complexity. Whilst the rated output of turbines constructed just a few years ago was only 1 to 2 MW or was even still in the kW range, the current trend is towards much more powerful and larger turbines with rated outputs of 8 MW and more. According to wind turbine manufacturers, this trend is expected to continue in the coming years, which means that the relevant technology will have to do more and more.

The load on mechanical components such as bearings and gears, increases in line with increasing size and performance, which leads to multiple mechanical damages after just a few years of operation, which in turn often require premature and costly part replacements. However,

this situation is not expected to improve, because mechanical components are kept as small as possible for economic reasons, resulting in enormous stress on contact surfaces, which quickly leads to material fatigue and other kinds of damage. This damage can cause a total system failure after a given period, which in turn leads to expensive repairs and undesirable downtime.

REWITEC GmbH, a medium-sized company from Lahnau, and a subsidiary of the English chemical group Croda, provides an efficient solution to this problem, which consists of innovative oil and grease additives with protective and repair properties. In addition to surface protection, the technology in question also reduces friction and therefore temperature in gearboxes and bearings, which significantly increases the efficiency and service life of these components.



3 REWITEC surface modification steps.

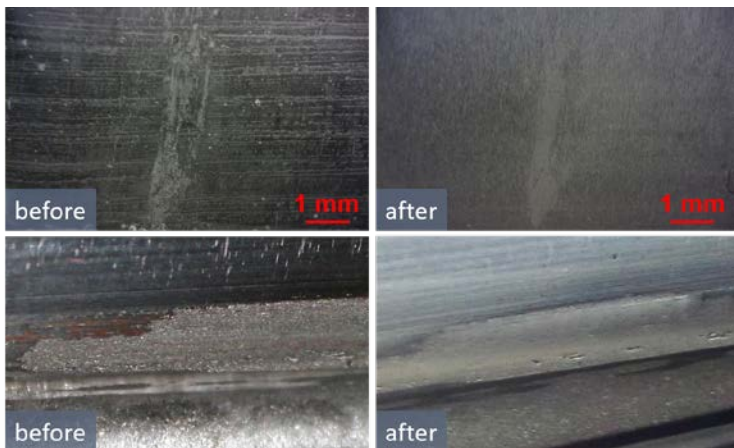

Microscopic (above) and photographic (below) images of a gear tooth flank before and after REWITEC application.

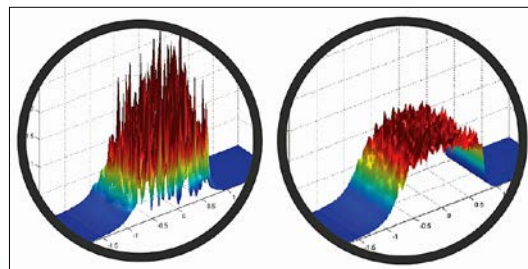

Load distribution on the rough surface before REWITEC application and on the smooth, modified surface after the application.

3 surface repair steps in a main bearing outer ring (before as well as 5 and 12 months after application).



The technology is based on phyllosilicates in the form of micro- and nanoparticles in addition to several other additives that optimise the effect whereby active particles use the lubricant as a carrier medium to reach the surfaces and cover them by means of adsorption. Where necessary, the particles remaining in the lubricant repair the built-up layer, which ensures a lasting and reliable effect. The new, modified surface has a significantly

lower degree of roughness, which leads to a more even load distribution within the system thereby significantly reducing local loads. This innovative technology has been tested in numerous experiments carried out in collaboration with several universities and colleges and is protected by the relevant patents. The product is currently being used successfully around the world, especially in the wind energy sector and this trend is increasing.

Conclusion

The layered silicate based REWITEC additives can optimise surface conditions from a tribological perspective, both in new and older systems to minimise friction, wear, surface roughness and temperature. Modifying the surfaces repairs and protects the components, which leads to a significant increase in the service life, reliability, and efficiency of the equipment.

Project overview

Initiator	REWITEC GmbH
Implemented by	pilot projects with representative turbine types, first main bearing applications with first result analyses
Facts and figures	over 3000 gearbox and bearing applications in wind turbines
Project status	Ongoing
Location	Worldwide



Are you interested in the project and want to know how your community or your business can benefit from it? Contact us. Our contact can be found in the company profile on page 120 ►

SUSTAINABLE PARTICIPATION

Participation opportunities for the neighbours of wind farms must be fair and social. The REZ has developed new concepts in collaboration with wind farms owned by the MLK Group.

In the hood

Wind farms often suffer from the fact that their operators are not based locally and not accessible to local residents. Even community participation projects cannot gloss over this fact. However, provided they are specific and structurally simple, such projects can encourage local residents to come to terms with wind energy and benefit from it. The direct economic benefits regions derive from operating wind farms are often barely tangible. If renewable energies want to be accepted by their neighbours, they need to offer more than trade income taxes and free beer at the local festival.

Wind farm participation concepts are designed to enable local residents to participate in the economic success of a project. In the early years, this objective was achieved through citizen-owned wind farms, a concept which is now moribund in terms of tax income and partly also from an economic perspective. Yet, citizen-owned wind farms are currently returning in a different guise in the form of cooperative and crowd funding models, although the entrepreneurial risk associated with investing in a wind farm is underestimated by most investors.

Socially responsible, specific and low risk

This is why REZ and MLK radically expanded their participation concept. Rather than mere economic participation, a broader spectrum of participation instruments was used. These also take account of social aspects, thus targeting demographic groups with no disposable income or who cannot risk their invested capital.

The MLK participation projects are also designed to be as specific and tangible as possible. Shareholdings in various projects or monies paid to the municipalities, as is the case in Mecklenburg-Western Pomerania and Brandenburg, are not visible to broad sections of the population.

Concrete offers

The projects implemented to date have included reduced tariffs for local power supply, various citizen savings projects with attractive interest rates and direct wind farm participation opportunities. A partnership agreement was also concluded with a day-care centre, which not only included agreements on joint projects, but under which equipment was provided and the daily supply of milk to the day-care centre was ensured. A central aspect of this approach is to provide personal support and to be in regular contact. Although this requires extraordinary efforts on the part of planners, operators, and managers, it is worth it, for both partners.

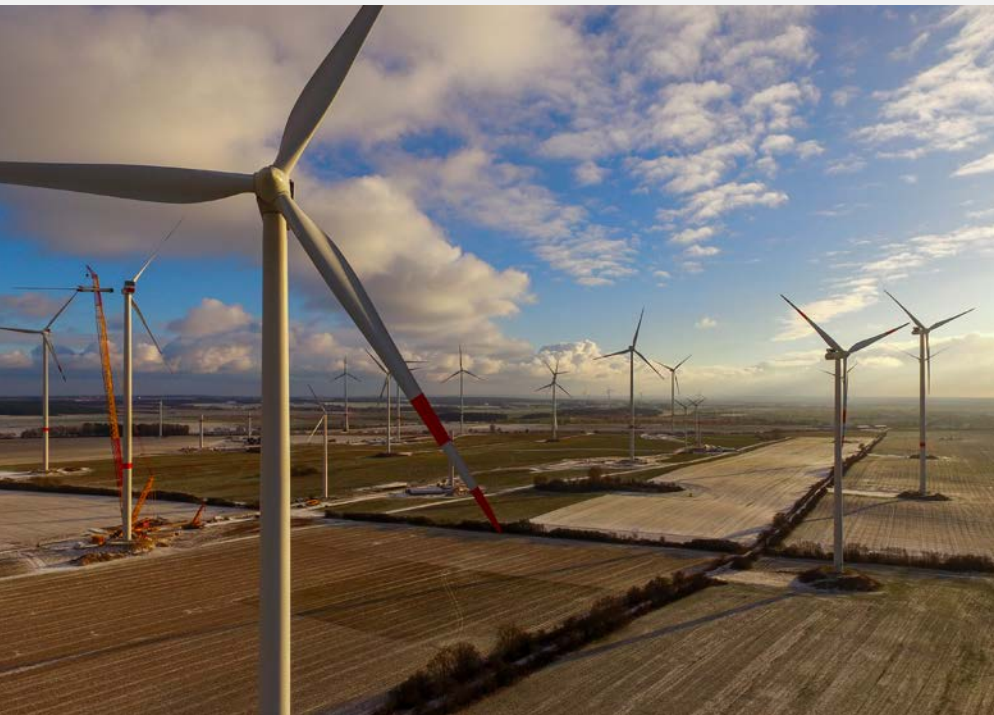

A subsidised neighbourhood electricity tariff was launched at two locations in collaboration with green electricity suppliers. The participating wind farms pay the electricity supplier an annual subsidy of between 156 and 180 euro per annum for each contract. One of the projects also receives a social subsidy of another 60 euro per year. As things currently stand, the local resident tariff is tax-neutral for beneficiaries and does not entail any reduction in unemployment benefits. MLK has also made its funding combinable with the funding of the neighbouring planner ENERTRAG at sites near Prenzlau, resulting in incredibly low-cost offers, despite offering green electricity.



Two citizen savings projects implemented with the DKB (Deutsche Kreditbank AG) in 2017 and 2020, provided a total of 200,000 and 300,000 euro respectively with an annual guaranteed interest rate of 3 percent. The investors were allowed to invest up to 10,000 euro per capita, and the programme was without any discernible risk for the investors because the deposited sums were secured by the bank security fund. The term in each case was three years.

Conclusion

Local participation concepts must take account of local conditions and also include demographic groups with no disposable resources of their own as well as groups with little funding. They should also be used to assume on-site responsibility either through electricity for residents, citizen savings schemes, participation through crowdfunding or collaboration agreements with kindergartens or other social institutions.

„Our objective is to provide effective and fair participation instruments for all residents without risking money.“

Heinrich Lohmann,
founder and managing director of the MLK Group

MLK is currently implementing another crowd-funding project with an interest rate of over 4 percent to enable groups with just a small amount of their own capital to participate in wind farm successes. To minimise the risk for the investors, a wind turbine is used which has already been in operation for about 10 years and whose feed-in is sufficiently secure. Conservative revenue estimates were also used. Again, this project is being supported by the DKB. The digitally designed crowd funding project will also be supplemented by local advertising measures to attract local investors. If necessary, digital laypersons can receive assistance in setting up their financial investment. The invested amounts can be anything from 250 to 25,000 euro, but an asset report must be provided by the investors for investments of 1,000 euro and above.



Project overview

Initiator	MLK Windparks in Brandenburg
Implemented by	Regenerative Energien Zernsee GmbH & Co KG
Facts and figures	<ul style="list-style-type: none"> • Neighbour electricity status: approx. 100 local electricity customers • Effort: between 156 resp. 180 Euros funding/customer • Social tariff (near FFO): an additional 60 Euros • Eligibility group: Neighboring locations add. conceptual and communication effort • Status: ongoing, campaigns approx. every 2 years
Project status	ongoing, campaigns approx. every 2 years

MLK Windparks

Lichtenberger Weg 4, 15236 Jacobsdorf OT Sieversdorf
 Phone: +49 (0)33608 17 99 97
 Email: info@mlk-consult.de
 Web: www.mlk-windparks.de

Regenerative Energien Zernsee GmbH & Co. KG

Bergstraße 1, 12169 Berlin
 Phone: +49 (0)30 224 459 830
 Email: zentrale@rez-windparks.de
 Web: www.rez-windparks.de



Are you interested in the project and want to know how your community or your business can benefit from it? Contact us. Our contact can be found in the company profiles on page 174 and 185. ►

ROBOTIC DATA INTELLIGENCE

Robotic Data Intelligence is the newest innovation in **OneView® SCADA Software**. The feature is designed to automate the cleaning, organizing and reporting stages of data collection.

It is a common staple that, in data science, 80 % of time is spent cleaning and organizing data, with only 20 % spent on analysis. With Robotic Data Intelligence, SCADA International gives you the opportunity to reverse those numbers, and reduce time spent on collecting and cleaning data. The goal of Robotic Data Intelligence is to give access to better data and improve the efficiency of Wind turbines, by automating the cleaning, when collecting data.

Robotic Data Intelligence takes data from multiple sources, cleans it by removing incorrect or duplicated data and fuses into concise and easy to access data, while also formatting it to ease the use of it.

The program is built to accompany features already found in OneView® SCADA. Robotic Data Intelligence works essentially in three stages:

- Automatic Data Enrichment
- Manual Data Optimization
- Advanced Reporting Engine

Automatic Data Enrichment is a patented solution for fusing multiple data sources into coherent and cleaned data. Missing critical events in data from turbines and OEM SCADA systems often cause problems. Therefore, the system is designed to automatically detect missing critical events from time counters in the turbine.

OneView® uses other data sources to “intelligently” cleanup event data. This is especially important when event data is used for generating lost production periods and thus availability.

“Errors in event data are not uncommon, and unfortunately their impact on the data quality can be drastic. Ideally, every single set of an event is followed by a matching reset of the same event. But sometime the reset of an event is missing and the consequence can range anything from a few minutes of data is wrongly calculated to several months of data wrongly calculated.”

Bo Lovmand, R&D Director of SCADA International

From raw data to smart decision making



Robotic Data Intelligence

Complete operational overview
Improved data completeness
Automatic downtime allocation



The solution has been developed with expert knowledge of different types of wind turbines, to give the best view of the turbine's operational situation, regardless of the model type.

The next step is the Manual Data Optimization. A system where it is possible for experts to manually allocate lost time events, before building reports. The final step is the Advanced Reporting Engine. A customizable system, which creates specialized reports on performance regarding production, budget and availability across your fleet of turbines. These reports can be made in different formats, including site and portfolio reports. One of the primary goals of the

reporting engine is to improve the transparency of the availability calculations. The engine must be capable of handling most availability formulas and show how the figures on the report is calculated, and the Advanced Reporting Engine can handle both operational and contractual availability.

It becomes possible to develop optimization strategies, that better utilize the equipment you have at hand, with more time spent on the solution, rather than finding the problems. By optimizing the data received from wind turbines, you can reduce downtime and thereby increase availability.

Collecting and cleaning data is one of the hardest and most time-consuming parts of running a fleet of wind turbines. But it is still vitally important, in order to complete reports and optimize in the future.

Robotic Data Intelligence is a feature, that improves your system's efficiency, by automating a process that would otherwise take many staff hours to complete.

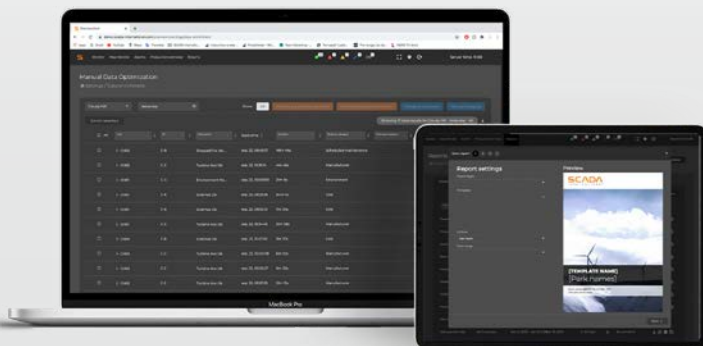

Location **SCADA International A/S**
A. C. Illums Vej 4A
DK8600 Silkeborg
Telefon:+45 (0)9641 9200
E-Mail:scada@scada-international.com
Internet:www.scada-international.com

SCADA
i n t e r n a t i o n a l

Are you interested in the project and want to know how your community or your business can benefit from it? Contact us. Our contact can be found in the **company profile on page 190** ►

PRECISE DETECTION OF LIGHTNING PROTECTION DAMAGE BY DRONE

Until now, lightning protection damage has been difficult to detect and conventional methods are overtaxed. TOPseven solves this problem: autonomously flying drones use special sensors to **locate the defect rapidly, without contact and with pinpoint accuracy.**

Wind turbines are a frequent target for lightning due to their height: every turbine is struck once a year according to experts. There is a risk of massive damage if the lightning protection is defective: the electrical control systems can be damaged by overloading, and, in the worst-case scenario, the turbine could catch fire. Therefore, insurers in particular are demanding regular lightning protection tests.

Previously complex troubleshooting: inside the rotor blade with the endoscopy camera

Professional rope access technicians currently test the lightning protection by measuring the low-impedance current resistance between the interception devices in the rotor blades and the ground connection lug at the base of the tower.

Apart from their limited availability, the most serious challenges are the height of contemporary on- and offshore wind turbines and the length of the rotor blades: the cables required for the tests often have to be up to 100 meters long.

However, the time-consuming process of identifying damage is by no means sufficient: the break in the conductor also has to be localised within the rotor blade. To locate the break between the tip and the root of the blade along its entire length, the experts have to drill holes in the structure and examine the lightning conductor using an endoscopic camera.

A globally unique TOPseven patent solves this problem with the contactless and autonomous drone-supported lightning protection test

Over many years, the Starnberg-based company TOPseven has developed a totally contactless lightning protection test procedure with the aid of an autonomously flying drone.

Various high-frequency signals are fed into the lightning conductor at the root of the rotor blade by a specially developed signal generator. The patented process generates an electric field with different frequencies and matching impedance values. The frequencies used have been approved by the German Federal Network Agency (BNetzA).



„The Starnberg-based company TOPseven gave us a demonstration of an impressive innovative solution for the drone-based inspection of a wind turbine today, which also allows for contactless lightning protection testing for the first time. We have been following this development for a long time and are pleased that today’s test gives rise to the expectation that this patented technology will eliminate inspection bottlenecks in the future and will make them even safer“.

Peter H. Meier
 Head of Wind Service Center
 TÜV SÜD Industrie Service GmbH

The counterpart, which is integrated into the autonomously flying Top7 drone, is a highly sensitive electrical 3D field sensor with an extremely low bandwidth and high sampling rate. If the sensor receives no signal at the tip of the rotor blade or if the signal strength is insufficient, it means that the lightning conductor along the rotor blade is damaged or broken.

The drone then autonomously flies along the rotor blade within just a few minutes and measures the intensity of the electric field, which enables it to identify the point at which the electrical field breaks down in a fully automated manner, thus pinpointing the damage precisely.

Conclusion

Conventional lightning protection inspection methods are overtaxed. The worldwide patented TOPseven process solves the problem: TOPseven’s contactless and autonomous drone-based lightning protection test system is scalable, saves a considerable amount of time and provides precise results in terms of functionality and, in case of breakages, their precise locations.

This makes TOPseven the only supplier to combine a completely autonomous optical on- and offshore wind turbine rotor blade and tower inspection with an advanced contactless lightning protection test system – rapid, precise, and efficient.

TOPseven – Drone Assisted Contactless Lightning Protection Measurement

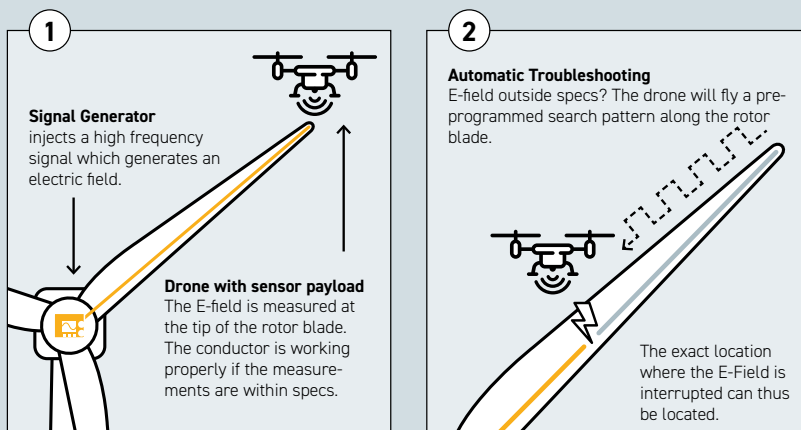

Location **TOP seven GmbH & Co.KG**
 Schiffbauerweg 1
 82319 Starnberg
 Tel. +49 (0)8151 95966-0
 E-Mail: info@TOPseven.com
 www.TOPseven.com



Are you interested in the project and want to know how your community or your business can benefit from it? Contact us. Our contact can be found in the company profile on page 195 ►



The start-up ExaMesh builds data centres in wind turbines, creating a second revenue stream for operators (page 80).
Photo: Manuel Hollenbach.



NEWCOMERS:

Start-ups

Start-ups are entering the market with new ideas.
A selection is presented on the following pages.
Be inspired by their innovative power.

Robotic wind turbine services

Aerones robotic technology is changing the wind turbine maintenance industry by switching away from the less efficient manual services to automated robotic solutions. This way we are able to provide the services FAST and SAFELY.



Aerones has developed a specially designed wind turbine maintenance technology to provide blade services more efficiently in comparison to traditional solutions and does not require having the rope-access technicians working on the blade.

Aerones technology offers safe, efficient, and environmentally friendly maintenance services which substantially decrease the operation and maintenance costs for the wind turbine owners and operators. The solution is based on a special winch system which allows for delivering different kinds of robotic tools (also specially developed by Aerones) for providing the services. The provided services list include:

- Lightning Protection System inspections;
- Visual inspections;
- Drainage hole cleaning;
- Blade cleaning;
- Internal inspections;
- Blade leading edge surface preparation for the following repair.

We are constantly working on improving the current solutions to provide even better services for our customers. At the same time, we are working on new technology development, such as blade painting; filler/coating application; tower cleaning; ultrasound inspections, and other services. Our goal is to provide a full blade service package by the Aerones technology. What is more, we are working on a solution for servicing the offshore wind turbines as well.

The biggest benefits of using Aerones technology are safety, speed, and cost-effectiveness.

Safety: Aerones technology allows for avoiding the need of having the rope-access technicians climbing the blades and allows them to do the same job from the ground by operating the robotic unit on the blade which performs the job instead.



AERONES

Aerones
 Latvia, Riga,
 Katlakalna iela 11, LV-1073
 Tel.: +371 2809 0999
 sales@aerones.com
 www.aerones.com

Founding year	Aerones: 2015 Started in wind industry: 2018
Number of employees	35
Focus	Wind turbine blade maintenance
We are looking for	Cooperation partners for developing offshore solutions



Conclusion

As the wind energy market is growing and wind turbines are becoming bigger, we believe that it is important to find an effective way to keep the turbines in good condition and maximize energy production. Innovation is the solution and Aerones technology could resolve these issues and improve the efficiency of wind turbine energy production in the long term.



Speed: The technology allows for much faster services in comparison to the traditional methods as it is much more mobile and can easily operate in a bigger area. Faster services allow to significantly reduce the downtime of the wind turbine during the services. For example, for the Lightning Protection System inspections, Aerones can provide the services for even up to 4 turbines per day, which is four times faster than by providing the services with the traditional methods. Also, by preparing the leading edge surface with the Aerones technology, we are able to save 2-4 days of the repair process per turbine.

Cost-effectiveness: By providing faster services, the downtime of the turbine is reduced as well, therefore saving the money for the customer in ungenerated electricity during the services. Also, as the services can be done by a robot, there is no need for highly experienced technicians to do the job, thus the costs of the services are lower as well.

The industry is highly interested in using such a solution for the wind turbine maintenance services as there are opportunities to reduce downtime, save money, and reduce the need for direct human labor to do the job. During this year, we have completed several projects for the biggest companies in the wind industry and it is expected to continue the cooperation with those companies in the long term.

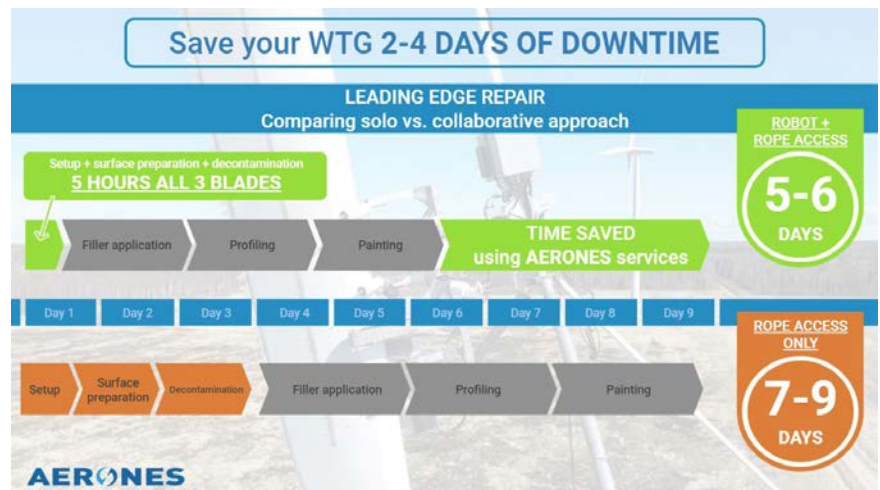

Innovative Condition Monitoring

cms@wind is currently in its 5th year. In recent years, we have established ourselves as a provider of sophisticated solutions that go beyond the range of commercially available condition monitoring solutions.

Almost all newer wind turbines with a rated output above 3 MW already include integrated condition monitoring solutions. Often, the information flow is so complex and the output so diluted that there is no added value to the end user. In 2019 and 2020, cms@wind has increasingly focused on developing solutions to this specific information deficit.

To this end, we extended our simple CMS-mobil solution to the new CMS Universal solution. In addition to the traditional vibration measurement, it is now possible to use this mobile device to measure imbalances and to integrate further measured variables. From traditional temperature measurement to control system signals and traditional analogue input variables, almost anything is possible. The device is completely self-sufficient and can be operated remotely. We customise the device to meet our customers' individual requirements.

CMS Universal is ideally suited for the standalone detection of hidden defects during the warranty period and for the integration of different wind farm systems.

We had to completely revise our previous user interface to make the installation process easier for customers. As with traditional mensuration technology, it is now possible for trained commissioning engineers to adapt measured variables to turbine behaviour on site.



cms@wind GmbH
 Am Diebsteich 31
 22761 Hamburg
 Tel.: +49 (0)40 63797707
 info@cms-wind.de
 www.cms-wind.de

Founding year	2015
Staff	4
Focus	Condition Monitoring for large slow-turning components in drive trains that move at variable speeds
We offer	<ul style="list-style-type: none"> - Independent measurements - Innovative CMS solutions for large slow-turning components in drive trains that move at variable speeds - Optimised for wind energy - Monitoring of slewing bearings, tested up to 4 m
We are looking for	<ul style="list-style-type: none"> - Contracts, new clients, partners - Interesting tasks related to measurement, periodic monitoring, new turbines, old turbines, reference measurements, resonance analysis, relation to other physical parameters - We start where others stop.



User-Interface

Turbine behaviour is displayed directly, rapidly and at high resolution on the monitor. Both the start-up of the turbine and component behaviour can be viewed immediately. To make this possible using inexpensive hardware has demanded a lot from us in recent months.

Defects which have long gone undetected, such as strong elevations when passing through the resonance range during operation, become immediately visible and can be recorded separately by on-site personnel. If necessary, we can provide support via remote access and/or can preconfigure the technology.



Screen output

Following our decision to include MEMS sensors in our online system portfolio in 2018, we have now integrated this sensor technology into our mobile solutions. In addition to traditional mass imbalances, the aerodynamic influence of blade angle deviations can now be measured.

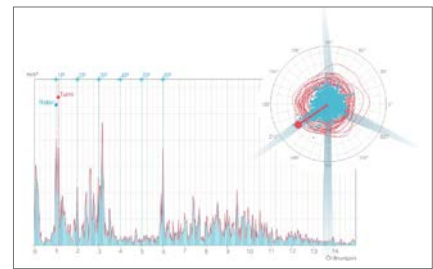

Our core focus is on analysis. We process the database for our customers and are not fazed by large data volumes of up to 20 TB. We then compare the mobile device results with output from established providers.



Conclusion

As a recently established company we cover quite an exciting potpourri of applications and are looking forward to seeing how the wind energy market will develop in the next few years. We are always open to exciting challenges and are receiving more and more orders from other sectors in which we offer CMS development services, especially during the winter months. We have also been using large test benches for wind energy since 2019.

Solar folding roof for infrastructure zones

The **Horizon folding solar roof** is a patented lightweight structure that doubles the area of infrastructure zones without restricting the space below. A meteo-algorithm automatically controls and protects the lightweight construction against storms, hail, and snow.



For the first time ever, the Horizon folding solar roof enables the genuine dual use of infrastructure such as sewage treatment plants, parking, or logistics spaces. On the one hand, the ground, which has already been sealed is used twice, whilst on the other the spaces in question remain fully passable and manageable. Even trucks can drive under the solar folding roof without issues. The lightweight construction technology utilises glass-free modules, Swiss cable car technology and a meteoalgorithm and supports a structural height of 5–7 m above ground and column spacings of up to 30 m. The lightweight solar folding roof is only partially weathertight and is retracted into a protected

position during storms or in the event of hail or snow. Yet, at the same time, this retraction enables crane access to a given area and avoids yield losses due to snow. The pleasant shade keeps vehicles and goods cool in parking and storage spaces and reduces the formation of algae in wastewater treatment clarification tanks.

Dhp technology was founded in 2015 and currently employs 30 people and is managed by the two founding partners Andreas Hügli and Gian Andri Diem. Dhp technology has built a highly automated production line at the company site in Zizers in the canton of Graubünden, Switzerland, and can therefore deliver

The shady solar folding roof enables us to offer our guests who arrive by car even more comfort. I am also pleased that the Kronberg cable car company, has been able to construct this unique power station in collaboration with SAK, thus providing an example of how to implement the Energy Strategy 2050.

Thomas Bischofberger, Chairman of the Board of Directors of Luftseilbahn Jakobsbad-Kronberg AG



dhp technology AG
 www.dhp-technology.ch
 LinkedIn: www.linkedin.com/company/dhp-technology/
 Facebook: www.facebook.com/dhptechnology

Founding year	2015
Staff	30
Focus	Solar folding roof for integrating PV into infrastructure
We offer	A solar folding roof that allows dual use of infrastructure without restricting the primary use.
We are looking for	customers with areas > 1,000 m ² , EU sales partners and investors for growth within the EU

the folding roof component groups, each of which consists of 40 modules, to the project site fully assembled and cabled. Our services include the development, production, installation, and maintenance of the solar folding roof in addition to sales and planning, to which end we collaborate with selected partners. We completed seven projects in sewage treatment plants and one project in a car park between 2019–2020, all in Switzerland, and planning contracts are already in place with various German companies.



The Horizon folding solar roof makes an important contribution to the sustainable use of resources, such as space and soil, through the dual use of infrastructure spaces already in use. It increases the self-sufficiency level of sewage treatment plants by up to 50 % and gives the customer additional financial benefits through the shade. In combination with electro- and hydrogen mobility, the solar folding roof can transform any asphalted surface into a mobility hub and provide the required energy locally in a renewable and economic manner. Having a shade over asphalted surfaces also reduces the urban heat island problem, i.e., local heating of the microclimate which can have harmful consequences for health. Incoming heat is greatly reduced during the day and the retracted solar folding roof allows the residual heat to radiate upwards overnight.

Solar folding roofs can be built to cover an area of approximately 1000 m² or 120 kWp and can be scaled as required, whereby the layout must be rectangular. As with flat roof systems, the monocrystalline PV modules are set at an angle of 10°, which allows optimum use of solar energy regardless of the orientation. The yield loss due to wind is usually less than 3% and implementation requires a standard building permit.



Conclusion

The solar folding roof opens the door to infrastructure-integrated photovoltaics and represents a successful new application for decentralised solar power generation. The first projects have been implemented successfully and are inspiring building owners, operators, and site visitors. For more information about the Horizon folding solar roof please visit www.dhp-technology.ch.

2020+ EEG remuneration going out – computing services revenue coming in

ExaMesh builds data centers in wind turbines and sells the computing power worldwide. Thus we create a second revenue stream for operators and help them to continue producing clean electricity even after 2020.

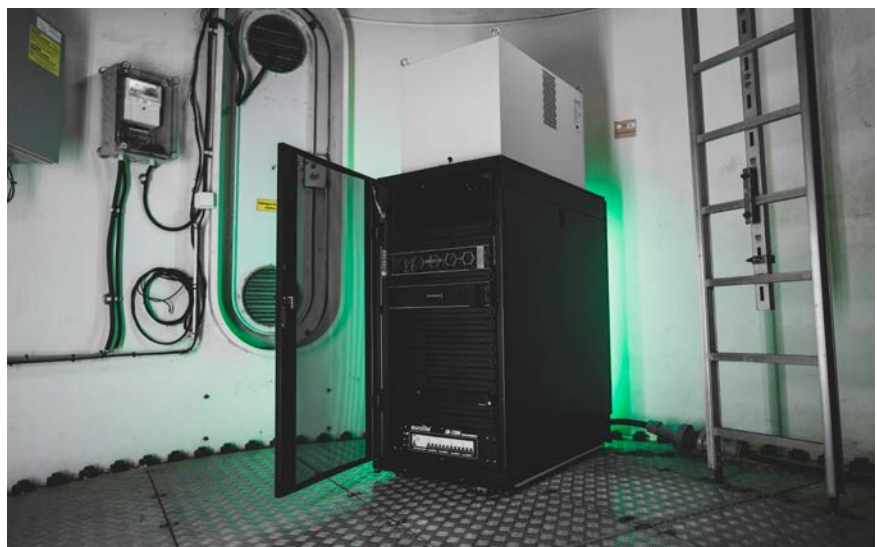

The ExaMesh Edge DC in the base of a wind turbine; Source: ExaMesh; Photo: Manuel Hollenbach

ExaMesh GmbH links climate protection and digitalisation. The EEG subsidies for thousands of RE plants are set to expire at the end of 2020. To be able to cover their plant operating costs, operators need to find solutions to sell their electricity through third parties. The electricity market currently offers no solution. The price of electricity on exchanges is at the bottom, and not only due to the Covid-19 pandemic. The remuneration achievable per kWh output is not sufficient to enable continued operations. Climate change notwithstanding, the market economy is forcing a shutdown.

But the market also offers opportunities: digitisation is booming. There are fears that the available computing power will be insufficient to cover the rapid and constant developments in AI, among other things.

We take advantage of the demand by installing Edge Data Centers (Edge DC) in renewable energy plants. Small, self-sufficient Edge DCs provide computing power where clean electricity is available and computing power is needed for networked mobility, industry 4.0, and agriculture 4.0 and many other applications, available immediately and everywhere, just like electricity.

We are already selling computing power from the renewable energy plants we have equipped to customers all over the world. “AI Docker Instances” our proprietary product, is the first application for the Edge DC’s, and is used by programmers around the globe, from the USA to Germany, China, India, Turkey, and many other countries.

We share the revenue of our computing power with the plant operators. For example, we manage to pay the operator of a 600-kW plant in Saxony-Anhalt with a full-load capacity of 1,000 hours 2 ct/kWh which they produce, although our servers only require about 5 % of the generated electricity.

According to the operator: „together with the sale of the remaining 95 % to our direct marketers we can continue to operate the plant“.

We are also meeting with the approval of the digital sector: our idea won us the Ludwig Maximilian University of Munich’s „Digicon Award“ as well as Deutsche Telekom’s „Hubraum“ Tech Incubator.

EXAMESH

ExaMesh GmbH
www.examesh.de/en

Founding year **2018**

Focus: **EDGE data centers**

We offer **data centers for installation in wind turbines to maximise their profitability**

We are looking for **Trusted partners in the market to upscale our business opportunities and owners of wind turbines open to innovative solutions.**

The future of digitization is decentralisation. Renewable energy operators have occupied some of this area. Partner with us and allow us to use your facilities to enable nationwide digitalisation and to further protect the climate.

When the people in charge of our demonstration project at Telekom asked us whether it was really possible to get the many RE operators excited about this project, we said „YES“. We have decentralised energy, so why shouldn't we be able to do the same with computing power?

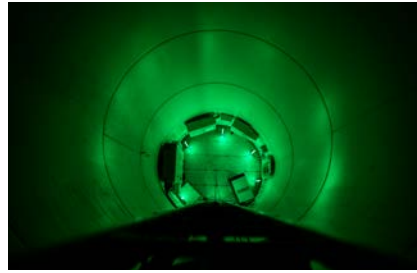

Left: The EDC (bottom right) in the base of a Nordtank 600 60/43.



Right: The installation, operation and maintenance of the EDC is carried out by ExaMesh.

Source: ExaMesh; Photos: Manuel Hollenbach

We are a start-up company that depends on collaboration and is seeking partners. We are receiving initial funding for this from the EU, which wants to respond to the Internet giants with an alternative European platform known as GAIA-X: the idea is for the ExaMesh Edge DC to become a GAIA-X node demonstrator.

Let's use our systems to create 30,000 nodes and digitise Europe and successfully protect the climate!

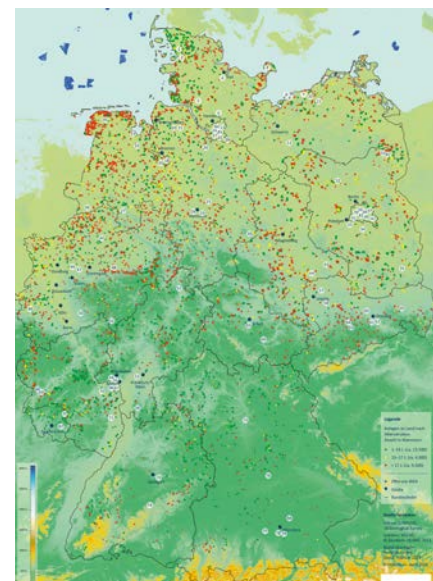

Potential decentralised locations for ExaMesh Edge EDC's in Germany;
Copyright: Ramboll Deutschland GmbH



Revenue development „Cloud System Infrastructure Services (IaaS)“ in € billion; Source: Gartner

Conclusion

Renewable energy producers will need support by the end of 2020. We have a solution that works best in collaboration. Climate protection and digitisation are converging. Europe is reinventing itself; the cards are being reshuffled and the odds are high.

ExaMesh can do digitisation and understands energy. We have proven that it works (www.examesh.de) and have convinced some major digital companies of our potential. However, we can only create change together.

Wind energy grid integration

morEnergy GmbH was founded in 2015 and manufactures innovative metering devices for the energy industry. The company stands for sustainable, green, and intelligent power supply with the aid of smart grids.



The original concept – our Online Network Impedance Spectrometer (ONIS)

The expansion and extension of wind turbines over the last 20 years poses new challenges for electrical grids. Whereas wind turbines use modern high-performance inverter systems and generally operate without issues, for them to operate reliably the interactions between frequency inverters and the power grid have to be well calculated when designing the controllers. Failure to do so results in operational instabilities which can lead to system failures. morEnergy's ONIS technology proactively prevents system integration issues and therefore system downtime and revenue losses. Local and frequency-dependent connection point

grid impedances in low voltage networks are measured quickly, objectively and during live operations using the ONIS-690V. It is possible to determine the grid short-circuit power from the grid connection points, which means that the connection conformity of wind turbines can be evaluated, taking particular account of their harmonics and other grid repercussions.

Furthermore, it is important not to neglect the increasing use of inverter systems by rapid electric car charging systems, high-rise elevators, server farms and photovoltaic systems, as they further exacerbate existing harmonic and power quality issues.

So, measuring the impedance makes an important contribution towards the integration of decentralised solutions into the power distribution grid therefore promoting the development of a sustainable infrastructure. Moreover, objectively measured frequency characteristics can be used to assess whether wind turbines comply with the applicable PQ regulations in a much more precise manner. Unleash the full performance potential of wind turbines with ONIS.



morEnergy GmbH
 Georg-Wilhelm-Straße 187
 21107 Hamburg
 Tel.: +49(0)40555546215
 info@morenergy.net
 https://morenergy.net

Founding year **2015**

Number of employees **11**

Focus **instruments for network impedance mensuration up to 500 kHz and supraharmonic detection, power quality measurements, consulting services for LV and MV grid integration, power grid simulations**

We are looking for **project partners in the industry and research sectors as well as sales partners around the world**

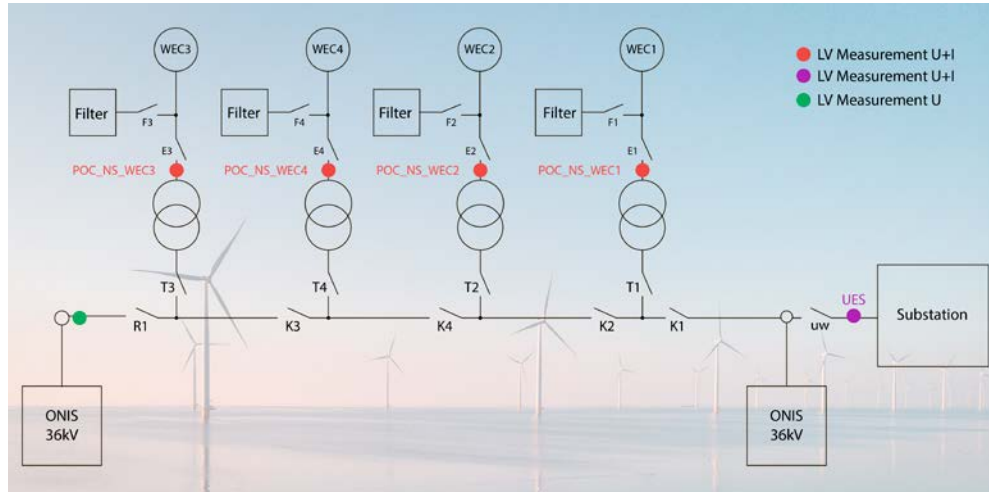

The next step – the MoMe for the grid 4.0

However, mains impedance measurements are only used selectively to avoid or eliminate problems, which, in and of itself, does not make existing grids smart. Yet, smart grids are necessary to develop the full potential of wind turbines by compensating for performance fluctuations.

morEnergy’s MoMe (MonitoringMe) tool is the answer to the digitalisation pressure of the distribution grids. The MoMe IoT platform enables efficient and secure data transfers between the mensuration units and the web servers.

morEnergy customers can access the distribution grid data via the intuitive MoMe web portal in real time and the mensuration data recorded is used to simulate the effects of performance changes on the grid in real time. This represents an unprecedented supply quality and enables grid operators to use real-time data for troubleshooting purposes in addition to enabling early warning messages to be issued in the event of critical operating states.

The MoMe application also provides the user with an overview of equipment ageing so that preventive maintenance measures can be planned and initiated before failures occur.

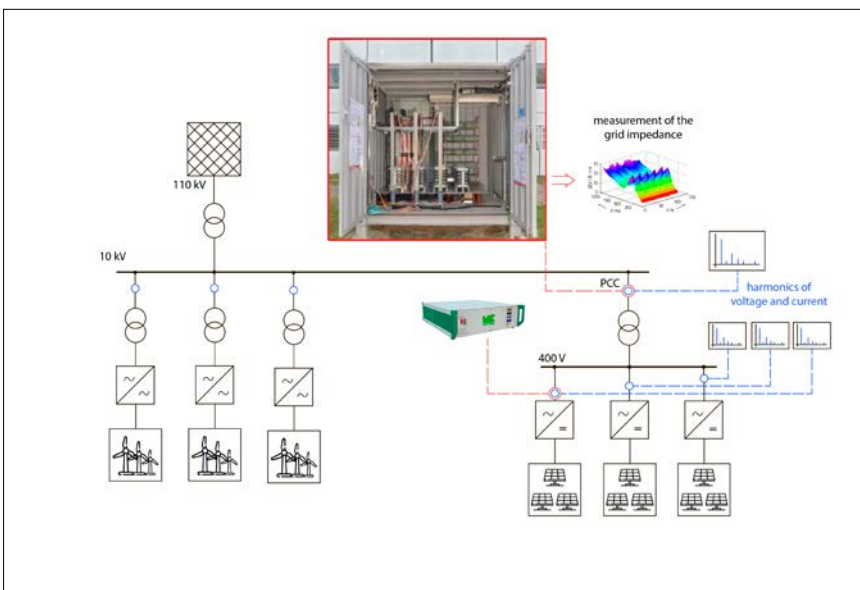

Conclusion

ONIS combined with MoMe – the electrical grid 4.0

The interaction between the ONIS and MoMe applications enables unprecedented real-time load management for voltage maintenance as well as for the prevention of grid overloads including predictive maintenance. Wind turbines and other generators can be connected at points where it makes the most technical and economic sense, avoiding unnecessary costs for grid upgrades and proactively identifying and eliminating fault sources.

The world's first modular wind energy system: efficient and scalable

The most important technical and economic challenge in the near future will be the supply of renewable, environmentally friendly and above all cost-effective energy. The Berlin-based start-up **MOWEA** is well aware of this and is taking on the challenge.

MOWEA provides small wind energy solutions based on the Lego principle. In a first step, the manufacturer is concentrating on scalable industries and B2B applications. While PV has benefited from increasing standardisation over the last two decades, enabling even small plants to operate efficiently, this is not the case in the field of small wind energy. MOWEA's aim is to set a new global standard and to become the world's first point of contact for flexible, demand-driven wind energy solutions.





MOWEA GmbH
 Storkower Straße 115a
 10407 Berlin
 +49 (0)30 23 52 61 11
 www.mowea.world/de
 kontakt@mowea.world

Founding year **2016**

Focus **Energy technology & renewable energy systems**

We offer **Efficient, scalable and modular small wind turbines and technical expertise**

We are looking for **Industrial project partners, sales partners, production capacities**



MOWEA was founded as a spin-off at Berlin Technical University. It all started with the IBB-ProFit R&D project “Mowian”, which successfully validated a method to reduce the costs of small wind turbines: a multi-rotor system consisting of a large number of highly efficient microturbines which can be produced in great numbers.

Traditional small wind turbines still lack quality and standardisation, which makes them cost-intensive and expensive. The decisive advantage of MOWEA wind turbines is the scalability of cost-effective, standardised and modular components designed for mass production. Through the innovative use of high-tech, highly efficient aerodynamics and state-of-the-art control technology, MOWEA is setting new standards in small wind turbine

technology and reaches top performance values in energy production (certified by Germanischer Lloyd).

MOWEA offers the ideal complement to solar/photovoltaic systems for independent energy supply in industry, real estate and urban areas. The use of several identical small wind generators in one interconnected plug and play technology system ensures high efficiency and allows for flexible applications of the MOWEA systems.

Together with the telecommunications giant Vodafone, MOWEA, was the first company to install a wind power system on a mobile phone mast in December last year. MOWEA is helping Vodafone to achieve their ambitious climate objectives in accordance with the motto “mobile telephony is going green”. A further 50 wind-power locations are in the planning stage and over 1000 potential roll-out sites have been defined.

MOWEA is also receiving support from the Vodafone Accelerator Uplift. The goal is to make MOWEA turbines for mobile phone masts a success story, and not only in Germany. Other regions in which Vodafone has a presence, and especially off-grid regions, such as India, are showing great interest in the technology.

Conclusion

Climate targets will only be achievable using hybrid systems and a mixture of various renewable energy sources. So far there has been a lack of efficient and above all cost-effective small wind power solutions with flexible application possibilities. MOWEA wants to complete this important piece of the puzzle.

Energy cost optimisation thanks to artificial intelligence (AI)

Olmatic GmbH is developing energy management and digital networking products. Their portfolio includes central control units and wireless sensors as well as power units for Industry 4.0 and the eMobility sector.

Many traditional energy efficiency measures designed to achieve the much needed CO₂ reductions often reach their limits and have to be replaced by novel and innovative technologies. Here it is important to reduce the increasing technical complexity at the customer end and to provide them with solutions that are easy to implement and can be integrated into existing systems without increasing costs.

This is precisely the focus of Olmatic GmbH, a startup founded by the brothers Tobias, Christian and Patrick Olma in 2016 and their “Olmatic Power Tracking” product. This energy management system is designed specifically for the industry. Energy sector load peaks are automatically recognised by an AI algorithm and compensated for by the intelligent purchase of regenerative energy sources and storage solutions. This significantly reduces energy costs for businesses, promotes important sources of electricity, such as wind energy, and also makes a sustainable contribution in terms of compliance with CO₂ reductions as required by law.





Olmatic GmbH
 Lise-Meitner-Straße 21
 72202 Nagold
 +49 (0) 7452 9299710
 info@olmatic.de
 www.olmatic.de

Founding year	2016
Staff	7
Focus	energy management
We offer	We provide central control units, wireless sensors and power units for highly innovative energy management
We are looking for	industrial project partners, sales partners, collaboration opportunities



Peak load prediction using AI.

To optimise energy costs, the system uses integrated wireless energy measuring sensors to produce a permanent record of the relevant energy parameters of any given power consumer in real time. It then digitises them and stores them in a central storage location. The specially developed AI algorithms continuously analyse the database to identify patterns, which in turn provides information and inferences about when and for what reason a peak load occurred at the consumer end. "Making a peak load forecast as detailed as possible", says Tobias Olma, who is in charge of technical product development, "requires maximum transparency and a large amount of data per consumer. It is no longer sufficient to measure the total consumption at the main connection point alone. Instead, we need to collect data about the individual consumers who contribute to total consumption. This is the only way we can train AI in an optimised manner to make correct predictions for the future".

The in-house software supplied with the system generates a visual representation of the recorded data in real time. As soon as the software recognises or is able to predict a peak load with the support of AI, regenerative energy sources and storage can be added automatically. Alternatively, it is also possible to use targeted load shedding, i.e., targeted shutdowns or regulation of defined consumers to counteract the detected load peak. To illustrate just one part of the further possibilities of Olmatic's EMS system, wind energy load peaks, for example, could also be shifted to other sectors in an intelligent manner by means of targeted sector coupling.



Conclusion

The start-up Olmatic delivers an innovative energy management system marketed under the name 'Olmatic Power Tracking' that achieves maximum added value for industry sector businesses through the intelligent use of renewable energy sources. Wireless sensors attached to any power consumer can create maximum transparency, and all energy parameters, which form the basis of an AI system, can be recorded. Proprietary algorithms make detailed peak load forecasts, thus saving the company excessive costs.

WTS 3D Serrations (silent-blades)

Wind-Tuning-Systems GmbH (WTS) has developed a novel 3D geometry for TES with a significantly higher noise reduction function of up to 3.2 dB(A), which enables new potentials for yield increases, improved night operations, site utilisation and repowering.



WTS' conventional 2D design

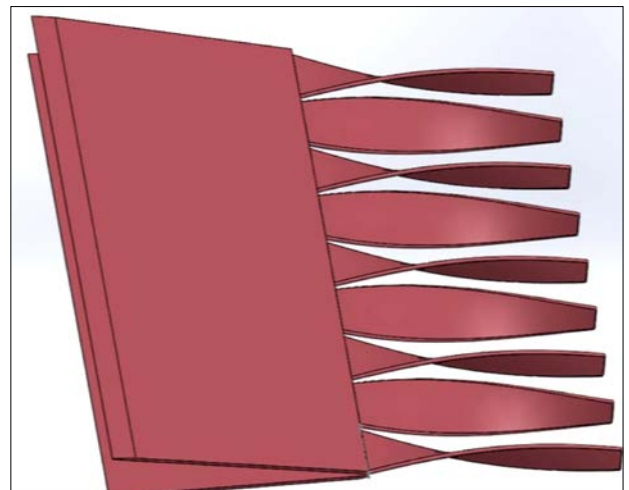

WTS' new WTS- 3D design

Reducing noise and increasing yield
(win-win situation)

WTS has developed a new patent-protected 3D geometry for TES, which enables a significantly higher degree of noise reduction, currently of up to 3.2 dB(A), compared to the 2D designs that have been in use to date.

This makes it up to 3.2 dB(A) quieter compared with a wind turbine with no serrations. This is particularly noticeable in the 1,000–3,000 Hz range, to which human ears are most sensitive, which paves the way to new ways of increasing yields through improved night operations, expanded site utilisation, repowering and improved acceptance by neighbouring communities.

WTS specialises in the development and distribution of aerodynamic add-ons for wind turbines. In collaboration with a global serrations producer within the wind industry, we are able to offer our products in “Made in Germany” quality, in large quantities, and at an attractive price. The ROI for the operator is 1–2 years.



“In the middle of every difficulty lies opportunity.”

Albert Einstein



WTS – Wind-Tuning-Systems GmbH

Arbachtalstr. 6
H3-Gebäude, 1 Stock
72800 Eningen u.A.
Tel: +49 151 18947012
info@wts-online.eu
wts-online.eu

Founding year	2016
Focus	Energy technology, renewable energy systems, wind energy
We offer	Highly efficient noise reduction solutions / add-ons; serrations and technical expertise
We are looking for	further partners for pilot projects, rotor blade service providers, investors, licensees

Our fastening method (patent pending), which is installed simultaneously on the upper and lower side of the rotor blade using a V-shaped base element, enables an extremely durable fastening compared with current state-of-the-art methods. Having your turbine rotor blades fitted by experienced wind energy service providers will guarantee a very long service life for WTS-Serrations.

Based on our novel WTS-3D-Serrations design, WTS intends to achieve noise reduction levels of up to 6 dB(A) in the future by using additional noise reduction technologies and scattering effects, which is up to twice as much as can be achieved by the serrations currently available on the market, which typically reduce noise by 1.5 to 2.7 dB(A).

Thus, WTS is actively tackling the most urgent current issue in terms of the expansion and operation of onshore wind turbines, which is due, not least, to the LAI recalculations/remeasurements of the noise emissions of wind turbines in all German federal states.

Increased yields

The additional noise reduction has a direct effect on existing systems in the form of an increase in yield because it is possible to avoid night-time shut-offs and reduced night mode operations (3 - 6 % increase in yield). Wind turbines at noise-sensitive locations can be operated at the optimum operating levels without violating the noise emission limits.

The additional noise reduction of up to 3 dB(A) opens up new options for repowering wind farms, enabling the use of up to 100% more wind turbines at the same location.

Because of the additional noise reduction, using the WTS-Serrations technology on new turbines enables the use of longer rotor blades with a higher rated output.

Due to the high yield increase as a result of noise reduction, the ROI period for the retrofit investment is just 1 to 2 years.



WTS' novel noise scattering effect (green arrows) and reduced noise (purple arrow).

Conclusion

Current status: The WTS-3D-Serrations technology has already been confirmed in complex noise simulations. The validation testing was carried out with the support of our partner Dassault Systems using professional noise emission validation simulations. Our WTS-3D-Serrations will be certified in the near future based on certification testing on pilot turbines on a wind farm in Schleswig-Holstein.



Nordex: Production of machine houses in the Rostock based plant „DMR“. Photo: Nordex/Ove Arscholl

COMPANIES:

Manufacturers of wind turbines

German manufacturers have a high share of the world market, reaching an export rate of 60 to 70 percent. The technology and efficiency of their turbines set standards and are sought-after globally.



ENERCON GmbH

Innovative products and a forward-looking company.

Innovative technology, outstanding reliability and excellent returns on investment for over 30 years. The German wind energy converter manufacturer has installed over 30,292 wind energy converters worldwide with a total power of more than 53.06 gigawatts.



For more than 30 years, ENERCON has been among the technology leaders in the wind energy sector. It was the first manufacturer to focus on a gearless drive design, and this is now a hallmark of all ENERCON wind energy converters. The company is also at the forefront in other areas such as rotor blade engineering, control systems and grid connection technology, and keeps proving its great innovation capacity with a variety of new technological developments.

Constant research and development are the key to the company's continuing success, along with production and service. All the key components such as the rotor, the annular generator and the grid feed system are manufactured by reliable and highly-qualified certified suppliers.

- 01 | E-138 EP3 Wieringermeer
- 02 | E-160 EP5 Wieringermeer
rotor blade installation
- 03 | E-147 EP5 Paltusmäki





This ensures the high standard of quality and the outstanding reliability that are features of ENERCON wind energy converters. Another essential factor is the customer-oriented service, which guarantees operators and owners 97 % technical availability of their WECs. This holistic concept sets high standards in technology, quality and safety, thus consolidating ENERCON's position as one of the leading manufacturers of wind energy converters worldwide.

The product portfolio currently includes wind energy converters with power outputs ranging from 800 to 5,500 kilowatts. The latest addition is the E-160 EP5 wind energy converter with a rotor diameter of 160 metres. All ENERCON wind energy converter models are characterised by reliable technology, low maintenance and a long service life, and thus guarantee customers a high rate of return.

Thanks to their directly driven synchronous generator and the innovative and modular full-scale converter concept, ENERCON wind energy converters offer a wide spectrum of technical options for adapting to the grid conditions. This also includes a grid feed system certified to the latest grid codes, meaning ENERCON wind energy converters can be easily integrated into any supply and distribution grid structures.

In keeping with the mission statement 'Energy for the world', ENERCON promotes renewable solutions for supplying power the whole world over. To support this, ENERCON is expanding its worldwide activities to meet demands. The company already has a decentralised service and sales network in over 45 countries

internationally. ENERCON's independence was sealed when the Aloys Wobben Stiftung trust was established in autumn 2012. On 1 October, founder and owner of the company Aloys Wobben transferred his shares to the trust in order to set ENERCON's sustainable and forward-looking business strategy in stone. As a result, high quality and reliable WEC technology are not the only things ENERCON's customers can count on – they can also be sure of a high level of investment security.



ENERCON GmbH

Adress	Dreerkamp 5 26605 Aurich
Phone	+49 (0)4941 927 0
Fax	+49 (0)4941 927 109
E-Mail	info@enercon.de
Web	www.enercon.de/en
Category	Manufacturers
Profile	Wind turbines (> 100 kW)
Founding year	1984

eno energy Gruppe

Success with wind

The name eno energy has stood for the highest quality in innovative plant technology for international wind farm projects since 1999.



We have branch offices in southern Germany, France, and Sweden in addition to our headquarters and production plant in northern Germany, which underlines the eno energy group's commitment to Germany as our core market as well as to France and Sweden as important target markets. eno energy has been successfully supplying and installing wind energy projects in these regions for over 20 years. Our product range covers reliable wind turbines with rated outputs ranging from 2.0 MW to currently 5.6 MW, and rotor diameters from 82 to 152 m.

Our extremely successful 4 MW wind turbine range offers proven solutions for repowering sites in Germany, as well as for sites in France and Sweden that are subject to height restrictions. This wind turbine is available with rotor diameters of 114, 126 and 136 m, and with selectable rated outputs ranging from 3.5 to 4.8 MW. With hub heights of between 82 and 142 m, the 4 MW wind turbine can be flexibly scaled to meet the respective site requirements. Our full power converter concept, which is standard in all eno energy wind turbines and has been established for over 10 years, also guarantees a grid connection that will always comply with the relevant guidelines.





- 01 | Plauerhagen wind farm
- 02 | Kölsa wind farm
- 03 | Production in Rostock
- 04 | Kölsa wind farm
- 05 | Kölsa wind farm

With our recently launched eno152 which has a rotor diameter of over 150 m, eno energy are now introducing our new 6 MW platform to the wind turbine market. With a rotor diameter of 152 m and a rated output of 5.6 MW, the eno152 represents a new milestone in the company's history in terms of yield and efficiency. The consistent ongoing development of proven concepts from the 4.0 MW platform, such as the four-point bearing drive train, full power converter with an electrically excited synchronous machine and split tubular steel towers, means that we can now launch a new generation of reliable wind turbines starting in 2021.

Long-term success and reliable operations are ensured through eno energy's robust service organisation. Due to our broad geographical distribution in Germany, France, and Sweden, eno Service is always close to customer projects and ensures optimal operating results over the entire wind turbine life cycle and beyond through a sophisticated full maintenance strategy.



eno energy Gruppe

Adress	Am Strande 2 e 18055 Rostock
Phone	+49 (0)381 20 37 92 0
Fax	+49 (0)381 20 37 92 101
E-Mail	info@eno-energy.com
Web	www.eno-energy.com
Category	Manufacturers
Profile	Wind turbines (> 100 kW)
Turnover	approx. € 100 million
Employees	about 200
Founding year	1999

Nordex Group

The Nordex group offers powerful wind turbines for nearly all geographical regions across the globe.

The development, manufacture, project management and servicing of wind turbines in the onshore segment has been the core competence of the Nordex Group and its more than 7,900 employees worldwide for 35 years.

As one of the world's largest wind turbine manufacturers, the Nordex Group offers high-yield, cost-efficient wind turbines under the Acciona Windpower and Nordex brands that enable long-term and economical power generation from wind energy in all geographical and climatic conditions.

The focus is on turbines in the 3 to 5MW+ class, and the Group's comprehensive product portfolio offers individual solutions both for markets with limited space and for regions with limited grid capacities.

In September 2017, the Nordex Group launched the N149/4.0-4.5, the first product in the new Delta4000 product series.

This was based on the proven technology of the Delta generation turbines successfully installed since 2013 for locations with strong, medium and light wind speeds.



The N149/4.0-4.5 has a variable output of 4.0 to 4.8 MW and can be optimally adapted to the individual specifications of the grid operator, local wind conditions, and sound requirements. This worldwide first installed +4MW turbine was awarded the title of "Turbine of the Year 2018" by the trade magazine "Windpower Monthly". In April 2018, the N133/4.8, a variant of this turbine type specialized in strong wind regions, was also launched on the market.

Based on the experience gained with the turbine presented two years ago, already installed and in series production since March 2019, the latest Nordex Group turbines, the N149/5X and the N163/5.X, were presented in 2019. With both turbines, the company entered the 5MW+ class.



As with the N149/4.0-4.5, flexibility is a key factor in the design philosophy and operating strategy of the new turbines. The turbines cover a wide range of power modes and suitably optimized for low and medium-wind regions. Depending on the investment criteria of the respective projects, the turbines can be operated flexibly in terms of capacity factor, rating, service life and noise requirements, and thus can also be optimized for the respective business model of the customer.

The Nordex Group can also implement wind farms as part of different project types: from simply selling the equipment to turnkey projects. A global service network, with some 280 service points throughout 30 countries, delivers service quickly to keep our systems running smoothly.



The Group covers the needs of all customer segments within the global wind market, from large energy suppliers, to SMEs operating power plants. Nordex Group systems currently deliver more than 29 GW of sustainable energy each year and can be found in more than 85 % of the world's energy market (excluding China).

Nordex SE is listed on the TecDAX of the Frankfurt Stock Exchange (ISIN: DE000A0D6554). The management holding company is headquartered in Rostock, while the executive board and administrative offices are based in Hamburg, both Germany. At production facilities in Germany, Spain, Brazil, the US, Argentina, Mexico and India, the Nordex Group produces its own nacelles, rotor blades, and concrete towers. The Nordex Group maintains offices and branches in more than 40 countries.



Nordex Group

Address	Langenhorner Chaussee 600 22419 Hamburg
Phone	+49 (0)40 30030-1000
Fax	+49 (0)40 30030-1100
E-Mail	info@nordex-online.com
Web	www.nordex-online.com
Category	Manufacturers
Profile	Wind turbines (> 100 kW)
Turnover	> € 3.28 billion (2019)
Employees	> 7,900
Founding year	1985

Siemens Gamesa Renewable Energy GmbH & Co. KG

A market leader in renewable energies

Siemens Gamesa Renewable Energy is a global leader in the wind energy industry. With an installed capacity of more than 105 GW worldwide, we produce and install onshore and offshore wind turbines. We also offer a wide range of services.



Onshore: tailor-made solutions for optimal yield

Siemens Gamesa offers you an extensive range of onshore wind turbines for all wind classes and site conditions. With the Siemens Gamesa 5.X we are taking the energy transition to new heights. The new platform comprises the turbine models SG 5.8-155 and SG 5.8-170. With a rated output of between 5.8 and 6.6 MW and the lowest electricity generation costs on the market, new standards are being set. Both models offer maximum performance in strong, medium and low wind conditions. The rotor with a diameter of 170 meters is the largest in the onshore segment. Thanks to its highly flexible design, which enables an improved value chain, the platform is suitable for a wide range of sites due to its versatility. The new generation is the first to combine the best of both partners after the merger of Siemens Wind Power and Gamesa to offer outstanding quality and maximum reliability in operation.



As one of the most important players and innovative pioneers in the field of renewable energy, Siemens Gamesa has already installed projects in more than 90 countries, employing approximately 26,000 people worldwide.

Our broad product portfolio includes both onshore and offshore technologies as well as maintenance and repair services. In Germany, we are represented by Siemens Gamesa Renewable Energy GmbH & Co. KG in Hamburg. You will find sales offices in Kiel, Bremen, Stuttgart, Leipzig and Berlin.

- 01 | Starting signal for the wind park Letter Bruch in Coesfeld, where 13 of our turbines will be installed.
- 02 | Andreas Nauen is Siemens Gamesa's new CEO since June 17, 2020.
- 03 | Big Data for more wind power – at the Diagnostic Center in Brande, data from more than 300 sensors per turbine is evaluated to predict and prevent unplanned downtime.



We are a strong and trustworthy partner when it comes to project implementation, we do not shy away from any challenge and are able to support you with complex projects. Together with you, we develop customized solutions to realize profitable wind parks even at demanding locations. In our largest project to date in Coesfeld, for example, we established a new form of cooperation with Max Bögl Wind AG and SL Naturenergie. By increasing the in-house effort in purchasing and installation, the project developer reduces costs and optimizes the yield.

Services: digitalization reduces the cost of maintenance and operation

To reduce production downtime due to maintenance work, Siemens Gamesa typically capitalizes digital solutions: thanks to remote diagnosis and algorithm-based operational optimization, our services offer you a decisive plus in cost-effectiveness for your onshore and offshore fleet.

In addition, we use the latest digital technologies such as rotor blade analysis using drones or offer alteration such as the Smart Aviation Lights in accordance with new regulations.

In January 2020, we acquired the European service business of Senvion. With this acquisition, our multi-brand-service fleet grows to more than 10 GW worldwide. Being already the market leader in multibrand service, we intend to further increase the maintenance of turbines independent of the manufacturer.

We are also constantly working to improve our service offering through innovative and creative solutions. As a reliable partner, we have also succeeded in maintaining our first-class service throughout the entire Corona period, thus maximizing the availability of your fleet.



05



04



Hot Stones as a second life option for coal-fired power plants

Our electrothermal energy storage (ETES) is operating in the port of Hamburg for a year now. It offers a wide range of possibilities for decoupling energy production and consumption. It can optimize the yield of wind parks by making them less dependent on volatile energy prices. It can supply high-temperature heat for industrial processes, and it can transform coal-fired power plants into CO₂-free energy storage power plants by replacing the coal-fired boiler and feeding its energy into the steam cycle.

- 04 | With a rotor diameter of 222m and a maximum power of 15MW the SG 14-222 DD is the new offshore flagship.
- 05 | Since January 2020, Senvion's European service business is part of Siemens Gamesa.
- 06 | Prepared for sector coupling: Our ETES demonstrator with a storage capacity of 130MWh has been running in the port of Hamburg for one year.

SIEMENS Gamesa
RENEWABLE ENERGY

Siemens Gamesa Renewable Energy GmbH & Co. KG

Address	Beim Strohhause 25 20097 Hamburg
Phone	+49 (0)40 2889-8082
E-Mail	Deutschland@ siemensgamesa.com
Web	www.siemensgamesa.com
Category	Manufacturers
Profile	Wind turbines (> 100 kW)
Turnover	€ 10.2 billion
Employees	26
Founding year	1976

VENSYS Energy AG

More energy for our future

26,800 wind turbines using VENSYS technology and featuring a total output of 50 GW connected to the grid worldwide

VENSYS ENERGY develops and manufactures gearless wind turbines with high efficiency for maximum yield. Our trademarks are powerful turbines with a permanent magnet-excited multipole generator, a maintenance-free toothed belt drive for rotor blade adjustment, simple generator cooling and the full converter system with power plant properties.

Our 1.5 MW to 5S platforms consist of only a few high-quality and durable components. The simple, compact design, low maintenance costs and the advantages of wear-free systems are construction features that ensure increased yields.

Wind turbines optimized according to customer specifications are designed in individual project development processes that do not only meet the requirements of small wind farms but also integrate local interests at a community scale and cater for tailor-made supply solutions for companies.

VENSYS provides municipalities and investors with comprehensive, worry-free solutions, which includes planning tailored to individual projects, installation and grid connection as well as an attractive service package with guaranteed availability for the entire service life.



Production in small series also gives us the flexibility for individual adaptations. Based around the manufacturing concept, our own production at our headquarters in Germany lays the foundation for the permanent transfer of innovations into VENSYS products. State-of-the-art technologies thus go hand in hand with solid workmanship, comprehensive quality management and needs-based short delivery times.

Together with our subsidiaries, we offer a complete package of individually adaptable services. Continuous development of central turbine components with a high level of coordination guarantees seamless functionality and higher added value across the entire supply chain and the life cycle of the turbines. The range of services provided by the VENSYS Group includes full-scale converters and pitch systems, electronic components and grid connections as well as grid planning, grid integration and certification of the turbines.

The VENSYS Group has now also started its own in-house manufacturing and development of rotor blades.





**Reliable and profitable at any location.
Proven in endurance tests on four continents.**

Wind turbines from our German production facilities are connected to the grid in Germany, Poland, France, the UK, Spain, Cyprus, the USA and Canada. Additional markets are being explored, supported by our subsidiary in Poland and VENSYS Inc. in the USA.

As the driving force for advanced wind power generation, VENSYS exports its technology worldwide. Our successful licensing model combines innovative technology and know-how “made in Germany” with series production, market development and logistics in an internationally operating business network. VENSYS is therefore in a position to implement its own large-scale projects everywhere.



- 01 | VENSYS production facility in Neunkirchen, Germany
- 02 | VENSYS production facility in Neunkirchen, Germany
- 03 | VENSYS headquarters in Neunkirchen, Germany
- 04 | VENSYS training centre in Neunkirchen, Germany
- 05 | Brake: shipping ten VENSYS turbines to the USA

Our most important licensees, Goldwind and ReGen Powertech, manufacture VENSYS turbines as high-growth multipliers for India, China, Asia, the USA, South America, Australia and Africa.

VENSYS wind energy technology has stood the test of time on four continents: under a wide variety of climate and network conditions, even in regions with poor infrastructure. Utilizing regionally adapted service and customer-orientated support, more than 26,800 turbines with 50 GW are now connected to the grid.

Building on the expertise of nearly three decades of innovative engineering, we are already working on pioneering solutions for cold-climate and hybrid turbines.



VENSYS Energy AG

Adress	Im Langental 6 66539 Neunkirchen
Phone	+49 (0)6821 9517-0
Fax	+49 (0)6821 9517-411
E-Mail	vertrieb@vensys.de
Web	www.vensys.de
Category	Manufacturers
Profile	Wind turbines (> 100 kW)
Turnover	€ 100 million
Employees	163 in Neunkirchen, 90 in Diepholz
Founding year	2000



Photo: Winergy

COMPANIES:

Suppliers

Manufacturers of wind turbines from all over the world buy systems and components in Germany. Years of experience of the operational side together with specific research and development projects to reduce manufacturing and operating costs and prolong service life are much in demand everywhere.



Bachmann electronic GmbH

Secure the future of your wind farm

Bachmann electronic offers automation solutions for the most demanding onshore and offshore applications. The Austrian manufacturer has equipped more than 110,000 wind turbines, making Bachmann the global number one in wind automation.



01 | Smart Turbine Automation: In order to be future-proof, wind turbines must do their part to provide complex data. Bachmann creates an alliance of control, SCADA, park control, condition monitoring and data.

bachmann.

Bachmann electronic GmbH

Address	Kreuzackerweg 33 A-6800 Feldkirch
Phone	+43 (0)5522 3497 0
Fax	+43 (0)5522 3497 1102
E-Mail	info@bachmann.info
Web	www.bachmann.info
Category	Suppliers of electrical and electronic components
Profile	Controls, cables & switchgear cabinets
Turnover	€ 80 million
Employees	over 450
Founding year	1970

Bachmann delivers future-proof technologies, maximum availability and the highest quality from a single source. Above all, our customers benefit from 50 years of experience; we develop tailor-made solutions to solve the most demanding challenges in automation.

Automation solutions in every area of wind power

From controller systems and condition monitoring, to Wind Power SCADA and grid connection technology; we offer complete solutions for the wind industry. Our systems stand for extraordinary robustness, high performance and open, standardized interfaces. With our intelligent sensors and power management algorithms, your wind farm is open, flexible, and future-proof even under the most extreme conditions. Innovative, comprehensive system solutions allow for the efficient development of wind turbines and integrated predictive maintenance, increasing the overall productivity of your wind park.

Smart turbine automation/ operations management

- Modular, hardware/software architecture
- Model-based engineering in PLC, C/C ++, Matlab/Simulink®
- Integrated safety technology (Safety)
- Configurable access protection and logging ("cyber security")
- Configurable, scalable turbine software templates according to the IEC standard
- Grid measurement/monitoring and grid protection
- Certified, integrated CMS

Smart grid/park controller

- Smart Power Plant Controller (SPPC) certified according to the new VDE-AR-N-4110/4120
- Scalable, configurable hardware/software
- Energy/telecontrol protocols IEC60870, IEC61850, IEC61400-25, Modbus, etc.
- Web-based user/diagnostic interface

SCADA/visualization

- Modular, flexible, web-based SCADA system (atvise®)
- "Ready-to-use": wind-specific, configurable templates and functions
- OPC UA interface and IEC61400-25 based data structures
- Integrated, configurable access management
- Cascadable server structure

Lifetime Extension

- Remote monitoring software and service
- Turbines: Tower vibration/structure monitoring
- Rotor blade monitoring (load, structure) Retrofit solutions for turbine control, CMS, SCADA and park controllers

Maintenance/service/diagnosis

- Comprehensive service and diagnostic tools
- "ServiceCenter" for convenient, efficient software updates
- Data recorder for network monitoring and analysis
- Comprehensive support and training program

Bachmann Monitoring GmbH

Your turbines are in good hands!

Bachmann Monitoring delivers measuring systems for condition-based maintenance. Investment security and high turbine availability are founded on these Condition Monitoring Systems. From our competence center, we monitor many thousands of systems of a variety of turbine types and manufacturers.

At Bachmann Monitoring, our core competency is the measurement and analysis of vibrations, enabling the precise monitoring of onshore and offshore wind turbines. We have been based at the Jena/Rudolstadt technology park since 1998 and are certified by Germanischer Lloyd. In 2011, Bachmann Monitoring was acquired by Austrian automation provider Bachmann electronic GmbH.

Intelligent solutions: Remote monitoring services form the basis of the efficient monitoring of decentralized systems. Early detection and localization of weak spots secures system operation and increases yield in the long term. Diagnostics such as rotor blade and structural health monitoring facilitate structural and noise-based Condition Monitoring (CM), as well as vibration reports for the wind industry.

Bachmann offers both control-integrated condition monitoring solutions and type-independent versions. These systems enable, for example, safe monitoring of rotor imbalance and alignment of drive train components.

As a world first, the completely control-integrated CM system "Omega Guard" was certified by Germanischer Lloyd in 2012. This certification represents the unique position of Bachmann Monitoring in the market. Every Bachmann CM System meets international standards, for example IEC 61400-25-6.



Information model compatibility and information exchange are always guaranteed, and CM systems can usually be integrated into existing network structures and control center systems.

International – We currently monitor over 7000 onshore and offshore turbines worldwide with a portfolio including 27 different turbine manufacturers and approximately 81 different turbine types, ranging from 600 kW to 8 MW.

bachmann.

Bachmann Monitoring GmbH

Address	Fritz-Bolland-Str. 7 07407 Rudolstadt
Phone	+49 (0)3672 3186-0
Fax	+49 (0)3672 3186-200
E-Mail	vertrieb-monitoring@bachmann.info
Web	www.bachmann.info
Category	Suppliers of electrical and electronic components
Profile	Condition monitoring systems
Employees	more than 50
Founding year	1998

Beckhoff Automation GmbH & Co. KG

PC-based control: The universal control platform for wind turbines

With PC- and EtherCAT-based control technology, Beckhoff implements system solutions that have been tried and tested worldwide: more than 70,000 wind turbines all over the world have been automated using Beckhoff technology, each providing up to 10 MW capacity.

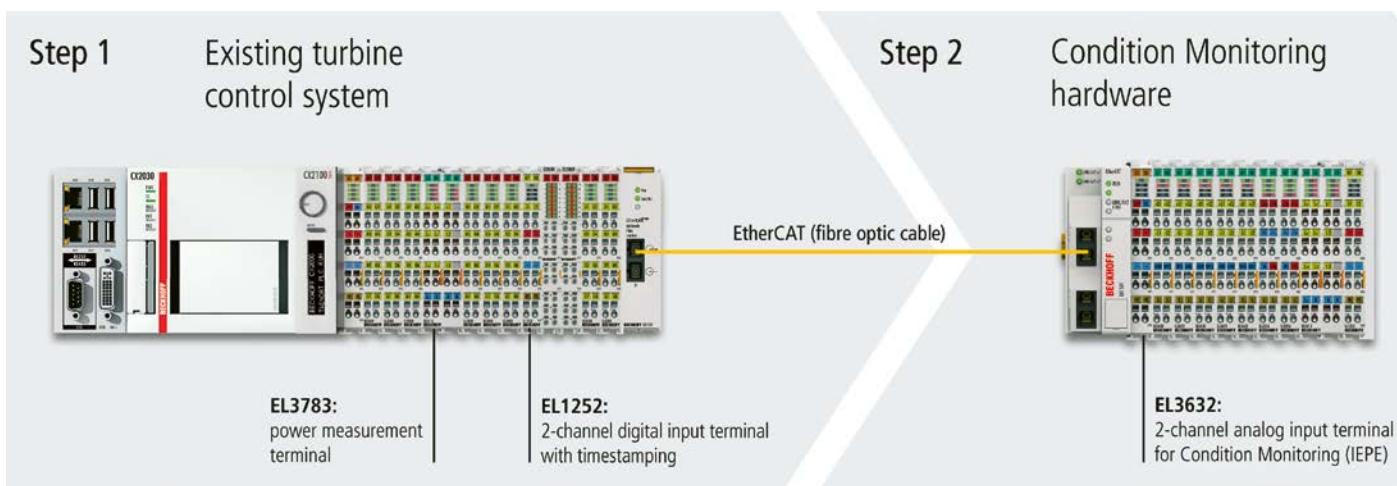

Reliable Condition Monitoring: easily integrated in three steps

An Embedded PC with line-connected I/O modules, EtherCAT as universal communication system and TwinCAT automation software functions serve as the central control system. The modularity of the hardware and software portfolio enables users to configure a controller that exactly matches the performance requirements of their system and allows subsequent extensions and modifications – such as for example a retrofit of Condition Monitoring functions, without great expense.

System-integrated Condition Monitoring

- Time-synchronous data logging in $\ll 1 \mu\text{s}$
- Reliable data analysis
- Enhanced diagnostics
- Increased system availability
- Longer service life of wind turbines
- Reduced maintenance costs
- Reduced system costs
- Enhanced competitiveness

The operation and maintenance of modern wind turbines incurs considerable costs. To maintain competitiveness, operators must minimise failure risks, reduce maintenance costs and increase the availability and energy efficiency of the system. This is where Condition Monitoring enters the game: seamless monitoring of gear units and generators is generally recommended, not just for offshore wind turbines or systems in remote regions, but for all. Beckhoff marries the powerful processors of modern PC technology together with EtherCAT as fast communication system, integrating Condition Monitoring functionality seamlessly into the controller. The vibrations of bearings or electrical machines are picked up by standard measurement terminals from Beckhoff and transmitted to the controller via EtherCAT. Configuration, programming and diagnostics are carried out within one system using TwinCAT.

Step 3

Condition Monitoring software

**System-integrated Condition Monitoring**

With improved error detection and holistic system analysis capabilities, the control system-integrated Condition Monitoring from Beckhoff is superior to conventional hardware-based Condition Monitoring solutions.

High-frequency data acquisition via EtherCAT Terminals

For grid voltage monitoring, two EtherCAT Terminals are available from Beckhoff: the EL3783 power measurement terminal with oversampling function for status monitoring in a 3-phase AC network, and the EL1252 digital input terminal with timestamp function for the chronologically precise detection of binary control signals.

The retrofit of a wind turbine with Condition Monitoring can be realized by simply adding a terminal block with the corresponding EtherCAT measurement terminals to the turbine controller. A multi-functional input for analog measurement technology is available in the EL3751 EtherCAT Terminal. The EL3632 enables the direct connection of various acceleration sensors via an IEPE interface and performs high-precision vibration measurement. Strain gauges (SG) can be evaluated via the EL3356-0010. The raw data are recorded synchronously ($\ll 1 \mu\text{s}$) with other system data, such as power and speed, which increases the reliability of the data and reduces the number of false alarms. A modular tool kit of mathematical algorithms for the analysis of measured values is available in the TwinCAT Conditioning Monitoring library. The library provides all essential functions for analysis, statistics and classification. Combining these algorithms with limit value monitoring is for instance, ideally suited to monitoring roller bearings.

We also recommend the utilization of special solutions from established third-party vendors, which can be directly integrated into the Beckhoff control platform, giving users access to extended diagnostics capabilities, reports, and long years of experience of these providers in consulting regarding monitoring.

If component-related threshold values are exceeded, the Condition Monitoring system triggers alarms to inform about wear, imbalances or impermissible operating states. In addition, the continuous machine monitoring can be carried out online. Trends in the characteristic values are analyzed and translated into recommendations for action, for example in the planning of maintenance intervals.

BECKHOFF

Beckhoff Automation GmbH & Co. KG

Address	Wahmstr. 56 23552 Lübeck
Phone	+49 (0)451 203988-0
Fax	+49 (0)451 203988-20
E-Mail	wind@beckhoff.com
Web	www.beckhoff.com/wind
Category	Suppliers of electrical and electronic components
Profile	Controls, cables & switchgear cabinets
Turnover	€ 903 million (2019)
Employees	4
Founding year	1980

Gram & Juhl GmbH

TCM® – KEEP THEM TURNING!

Gram & Juhl's TCM® (Turbine Condition Monitoring) system and services optimizes maintenance of wind farms all over the world. Now TCM® is also offered as a Cloud solution.



Predict the future and get a complete overview of your turbines.

Gram & Juhl has over 20 years of expertise in monitoring and analysing wind turbines and turning data into decision-supporting information. With the help of machine learning Gram & Juhl can foresee when turbine components are malfunctioning and need maintenance before they actually do.



Gram & Juhl GmbH

Address	Technologiepark 4 26129 Oldenburg
Phone	+49 (0)441 779 313 45
E-Mail	sales@gramjuhl.com
Web	www.gramjuhl.com
Category	Suppliers of electrical and electronic components
Profile	Condition monitoring systems
Employees	35 (Wind energy: 35)
Founding year	1997



New innovative Cloud platform

TCM® Cloud is Gram & Juhl's newest service in our ongoing focus providing the best tools for wind farm owners. TCM® Cloud is a software as a service offering flexibility, collaboration, and a low entry cost for all wind farm owners.

The TCM® Cloud service is a platform from where users can handle their wind fleet with all the tools included in the service for performing turbine condition monitoring. With the facilities of the TCM® Cloud the user will be able to issue their own internal "recommended actions" for their wind turbines, enabling organizations to plan for services and repairs, and ordering of spare parts with as much lead time as possible, which in the end will benefit operational expenses.

The TCM® Cloud Platform offers the possibility to collaborate internally, as well as externally with Gram & Juhl, if Gram & Juhl is to perform daily monitoring of the turbines. The user can adjust the service(s) when the fleet or strategy changes, as the platform allows for upscaling and downscaling depending on the current need, and Gram & Juhl takes care of the hosting of software and the data.

01 | New innovative TCM® (Turbine Condition Monitoring) Cloud platform

02 | TCM® is advanced diagnostic for early failure detection

HAWART Sondermaschinenbau GmbH

Wind power in motion – our passion – your success!

We meet our customer's requirements using innovative solutions. Our design and production facilities at Ganderkesee in Lower Saxony and our mechanical and electrical engineering activities meet the highest quality standards. Our customers associate HAWART with flexibility, reliability, and know-how.



U-BIT- the universal rotor blade installation tool

The U-BIT enables our customers to assemble and disassemble rotor blades weighing up to 27.5 tonnes directly on the wind turbine. We can modify it to fit different rotor blade contours by adapting the blade seats. The U-BIT is housed in a 40-foot container for effective and safe transportation to the construction site. Commissioning only takes an hour. The U-BIT can be folded up and loaded onto a trailer for repositioning within a wind farm.

U-BTS- the universal blade transportation system

In the field of logistics HAWART has become one of the leading manufacturers of rotor blade, tower section and other on- and offshore wind turbine component transportation and storage systems.

In collaboration with vehicle manufacturer DOLL, HAWART has developed a lifting adapter for the transportation of rotor blades by road with a load capacity of up to 35 tons.



The root of the rotor blade is connected to the hydraulic lifting adapter, the tip of the rotor blade is supported in two fixtures on a tandem frame, mounted on a precise self-steering trailer.

HAWART HINGE

We have been manufacturing hydraulic turning devices for rotor blade production moulds since 2005, which are used for positioning and glueing the fibre composite parts with highest precision. Our newly designed HAWART-HINGE 4.0 is suitable for all currently available rotor blade types. Our optimisation efforts have resulted in an extremely compact design with an even higher torque. It can be used with existing and future mould designs and the decentralised control meets with Industry 4.0 requirements.



- 01 | U-BIT – the universal rotor blade installation tool
- 02 | Lifting adapter and logistics components
- 03 | The powerful HAWART Hinge
- 04 | Transportation frame for marine transport

HAWART
windpower in motion

HAWART Sondermaschinenbau GmbH

Adress	Handwerksweg 8 27777 Ganderkesee
Phone	+49 (0)4222 941390
Fax	+49 (0)4222 9413960
E-Mail	info@hawart.de
Web	www.hawart.de
Category	Suppliers of large components
Profile	Rotor blades & rotor blade materials
Turnover	€ 17.0 million
Employees	100 (Wind energy: 100)
Founding year	1993

HELUKABEL GmbH

The Worry-Free Cable Experience

The professional cable solution for the wind energy sector



01 | HELUWIND® WK Serie
02 | Wind Turbines: Functional overview

HELUKABEL GmbH is one of the leading international suppliers and manufacturers of cables, wires and accessories. We provide optimised and individualised solutions for every application in wind turbine installation.

We will advise you on:

Nacelle: Cables with increased oil- and heat-resistance, special solutions for the slip ring

Loop: All torsion cables are tested for 18,000 cycles in our test-tower

Tower: Copper and aluminium cables, multi-wired and fine-wired, special lift cables, fibre optic cables and fastening systems

All requirements regarding climatic conditions from -55 °C to +145 °C, offshore applications, high fire-testing parameters as well as international approvals according to UL, CSA, FT4, CE, VDE and WTTCC standards can be met. These also include requirements regulating the North American market in compliance with the new UL 6141/UL 6142 standards. The Traycontrol cable series and an extensive portfolio of UL-listed products are available in stock.

Our top of the line model in the area of wind power is the WK 137-Torsion FT4 cable. It satisfies all the requirements of wind turbine manufacturers such as, increased nominal voltage of 1000 V, UL/CSA approval over a large temperature range without the use of halogen, and the demanding FT4 fire test of the CSA.

With its WK POWERLINE ALU cable, HELUKABEL is continually increasing its lead as a supplier of innovative products for the wind power industry. Thanks to its low weight and highly flexible design, aluminium conductors are closing a critical gap in power cabling. The specially developed connection equipment completes the product range.



HELUKABEL GmbH

Address	Dieselstr. 8-12 71282 Hemmingen
Phone	+49 (0)7150 92090
Fax	+49 (0)7150 81786
E-Mail	info@helukabel.de
Web	www.helukabel.de
Category	Suppliers of electrical and electronic components
Profile	Controls, cables & switchgear cabinets
Turnover	€ 592 million (2019)
Employees	2
Founding year	1978

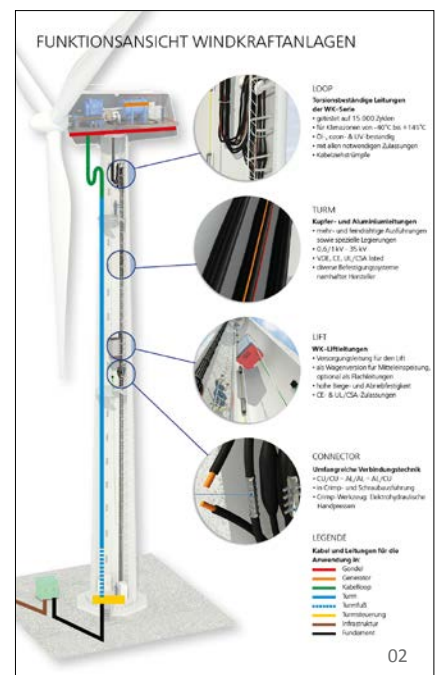

Lanthan GmbH & Co. KG

Combining aviation safety and acceptance by residents

Acceptance by residents and aviation safety are two outstanding tasks for the wind energy sector – and they are not incompatible. Lanthan produces products that impress in terms of their durability, sustainability, and local acceptance.



For 20 years, the core competence of the Lanthan companies and their 70 employees has been the development, production and planning of airborne obstruction lights, lighting systems and demand-controlled night-time identification systems for on- and offshore use around the world. Our comprehensive product portfolio includes bespoke solutions for all requirements and markets.

Our passion for the challenges faced by our customers is what makes us unique. Our engineering team develops flexible solutions in a short time and provides support until the goal is reached.

Minimising costs through sustainability:

We have never discontinued a product, because we develop them for long life and reparability, and even keep older product lines updated. We rework every returned lamp to produce an as-new replacement at a favourable price.

Acceptance by residents as a challenge:

One of Lanthan's key areas of expertise is the development of solutions that help gain local acceptance. Our beacons shine only as brightly as necessary.

The ARC-SIRIL, for example, is a modification of existing beacons with reduced visibility from the ground, whilst maintaining the same level of aviation safety. With special permission, the system can be used in Germany.

We have been pursuing the development of **demand-controlled night-time identification systems**, which are based on transponder signals, ever since the company was founded and have been working towards its introduction for many years – successfully: **Lanthan Safe Sky GmbH** was founded in April 2020. With over 20 employees, the company is working on implementing demand-controlled night-time identification systems, the first of which has been recognised under the new administrative regulations. **Lanthan Safe Sky** builds on the expertise of the three participating companies RECASE, AirAvionics and Lanthan.



01 | Lanthan obstruction lights by night
02 | Beaconing concept ARC-SIRIL
03 | Offshore obstruction lights



Lanthan GmbH & Co. KG

Adress	Jakobistr. 25A 28195 Bremen
Phone	+49 (0)421 696 465 0
Fax	+49 (0)421 696 465 11
E-Mail	info@lanthan.eu
Web	www.lanthan.eu
Category	Suppliers of electrical and electronic components
Profile	Aviation obstruction markers & lighting systems
Employees	50 (Wind energy: 40)
Founding year	2004

Max Bögl Wind AG

Aim high with Hybrid Towers

The future of wind energy lies in the most powerful turbine generations. With increasing capacity, wind turbines are growing higher and higher. These loads with record-breaking hub heights require a pillar that combines stability, quality and economy: the Hybrid Tower Bögl.

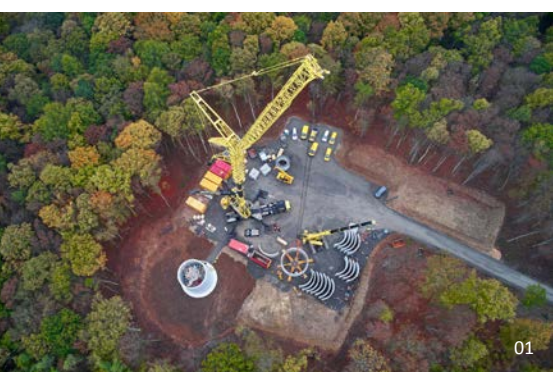

- 01 | Hybrid Tower Bögl erection
- 02 | Wind farm with Hybrid Tower Bögl
- 03 | Wind Worker Bögl during tower erection

With more than 2,000 hybrid towers erected, Max Bögl has developed a tower concept that is focused on the future market requirements. The combination of concrete elements and steel sections enables the economic realization of maximum hub heights while ensuring maximum stability for high-performance turbines.

In efficient serial production, the concrete elements are manufactured in two Max Bögl production plants at the Sengenthal headquarters and in Osterröfnfeld. From there they are transported to the construction site quickly, safely and sustainably by standard trucks, train and ship. Experienced assembly teams erect the Hybrid Towers within shortest time and in highest quality thanks to dry joints using the Lego principle. The construction method of the Hybrid Tower enables an easy dismantling after the end of the turbines lifetime. The concrete elements can be easily dismantled on-site and prepared for recycling.

For international projects, a mobile factory is producing the concrete elements directly on-site all over the world. This mobile concept enables a worldwide economic production of the Hybrid Tower, using regional workers and local raw materials.

In addition, Max Bögl also acts as an experienced turnkey partner for all project processes - up to the turnkey construction of entire wind farms. Qualified employees provide advice and support with efficient concepts for all services - from the initial idea to the operation of the plants. The services include the operational management and direct marketing of regional green electricity.

Max Bögl Wind AG is a subsidiary of the Max Bögl Group, which is one of the top 10 in the German construction industry with over 6,500 specialized employees at 35 locations worldwide and an annual turnover of 1.7 billion euros.



Max Bögl Wind AG

Address	Postfach 11 20 92301/92369 Neumarkt i. d. Opf.
Phone	+49 (0)9181-909-0
E-Mail	wind@max-boegl.de
Web	www.mbrenewables.com
Category	Suppliers of large components
Profile	Towers
Turnover	€ 1.7 billion
Employees	6,500
Founding year	1929



Megger GmbH

Megger products cover almost every application within the utilities industry from power generation to domestic power sockets. We have been a global leader in electrical testing and mensuration technology for 130 years.

Megger has been a global leader in electrical testing and mensuration technology for 130 years. Megger products cover almost every application within the utilities industry from power generation to domestic power sockets.

They are divided into seven main application segments: cable testing and diagnostics, protective relays and systems, circuit breakers, transformer testing and diagnostics, low-voltage systems, general electrical testing and motor and generator testing.

We have production facilities at various locations in Germany, the USA, Great Britain, and Sweden as well as a head office in Dover, England, and sales offices all over the world. The company has experienced considerable growth through acquisitions, which, to name just a few, include Biddle Instruments (1936, Pennsylvania), Multi-Amp (1951, New Jersey), Programma (2007, Sweden), SebaKMT (2012, Germany) and more recently Baker Instruments (2018, Fort Collins).

Our values are important to us at an emotional level, and the attitudes and behaviour promoted throughout the Megger Group are the direct result of our value-based approach. Our corporate culture not only makes us a successful company, but also, first and foremost, a convincing business partner. Get to know us.

Megger can support you with mensuration, testing, and training in the following areas:

- cable fault detection, cable testing and diagnosis
- protection relays and switchgear
- circuit breakers
- transformer testing and diagnosis
- low voltage systems
- general electrical testing equipment
- motor and generator testing
- battery testing
- earthing tests



01

- 01 | Megger office in Aachen
- 02 | Training area for practical applications
- 03 | Protection relay testing



02

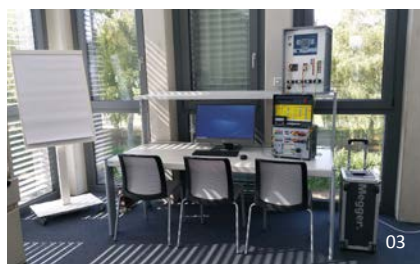

03

Megger[®]

Megger GmbH

Address	Weststraße 59 52074 Aachen
Phone	+49 (0)241-91380 500
Fax	+49 (0)241-91380599
E-Mail	Peter.Wienhold@Megger.com
Web	https://de.megger.com
Category	Suppliers of electrical and electronic components
Profile	Measurement equipment & measuring masts

Multigear GmbH

Dialogue with Experts

Spare- and exchange gearboxes – Overhaul & Upgrades – Own gearbox testbench
 Gearbox repair on site – Maintenance & Inspection / Endoscopy – Consultation & Training
 Spare parts management – 24h-Hotline



- 01 | Exchange gearboxes
- 02 | Workshop
- 03 | Overhaul and Upgrades
- 04 | Repairs on site

The team of Multigear GmbH, since decades in gearbox business, is thinking about one thing only: Service.

You are in good hands, independent by which manufacturer your gearbox has been built.

Our long-term experience in handling gearboxes and their damages offers the unique combination of know-how from a gearbox manufacturer and the absolutely goal to serve perfect service to the customer.

Our promise is always at your service: Within 24 hours (Europe) and 48 hours (worldwide) on site. Promised!



Multigear GmbH

Address	Am Flugplatz 34 56743 Mendig
Phone	+49 (0)2652 93605-0
Fax	+49 (0)2652 93605-20
E-Mail	info@multigear.de
Web	www.multigear.de
Category	Suppliers of mechanical components
Profile	Gears
Turnover	€ 7 million
Employees	38 (Wind energy: 38)
Founding year	2010

After working many years for a manufacturer of gearboxes for Wind Energy it has been realized, that essentials such as reliability, efficiency and confidential cooperation are the most important requirements in service business. In order to fulfill these essential criteria according to our conceptions, we are able to convert these points consequently, even under the pressure of daily business.



NGC Transmission Europe GmbH

Experts in excellent transmission solutions

NGC gearboxes are based on a concept that provides you with real added value. We regard products and services, as well as an optimised ratio between performance, quality, and price, as inseparable.

NGC Transmission Europe is a member of the NGC Group and has been active in the drive technology field for over 50 years, of which 19 have been spent in the wind energy sector. What this means for you is that we are extremely familiar with the specifics of the wind industry and have developed a corresponding service portfolio oriented towards the needs of our customers.

Whether it's pitch & yaw drives or main gearboxes up to 10 MW, for on- or off-shore applications, at -40 °C or +50 °C, NGC gearboxes prove their worth in any application anywhere in the world. Regardless of whether you need a customized solution or are convinced by the benefits of our standard gear unit series – you decide what best suits your particular use case.

NGC | Services

- Consulting
- Project planning
- Service engineering
- Up-tower and down-tower repair
- Maintenance
- Gearbox analysis
- Inspection (visual and by borescope)
- Independent oil analysis (certified laboratories)
- Re-engineering (incl. other brands)
- Gearbox disassembly
- Spare part kits
- Gearbox exchange pool
- Technical trainings
- Comprehensive documentation

02



03

Added value | Availability

Our engineering services, sales and other services are available around the world and are delivered by our experts to accelerate processes and enable you to plan for availability.

Added value | Security

You're in safe hands with us. Having supplied over 72,000 main gearboxes and more than 400,000 pitch & yaw drives in over 30 countries, NGC is one of the world's top three wind turbine gearbox suppliers.

Added value | Know-how

Our skills are based on what we do with passion. You'll benefit from experienced and creative minds as well as state-of-the-art software and machine technology.

Added value | Service

We know our gearboxes best. Our service and maintenance concepts, as well as the stocks of spare parts and replacement gearboxes we maintain, will ensure that you will be able to deal calmly with any issue of downtime.



01

01 | NGC | Gearbox Service Up-tower

02 | NGC | Gearbox Services

03 | NGC | More than 50 years experience



NGC Transmission Europe GmbH

Address	Schifferstr. 196 47059 Duisburg
Phone	+49 (0)203 509 600 0
Fax	+49 (0)203 509 601 90
E-Mail	wind-eu@NGCtransmission.com
Web	www.NGCtransmission.de
Category	Suppliers of mechanical components
Profile	Gears
Founding year	2014

NSK Deutschland GmbH

Partnership based on Trust – Trust based on Quality

For two decades NSK has been a partner of the wind industry and one of the main suppliers of roller bearings for wind energy gearboxes and bearings for main rotor shafts and generators.



NSK wind standard

As the first manufacturer, NSK defined the pioneering wind standard U303 for roller bearings back in 2008 – including a one hundred percent traceability of the components of every single bearing and all essential processes. NDT methods (non destructive testing) are also available to avoid grinding burn, fractures in material and structural breakdowns.

Combined know-how

Skills from sales and application technology are combined in the wind energy team – and also include the latest research results from our technology centres. Bearings are specifically designed using highly developed calculation and simulation tools. Our experienced engineers take account of load cycles, lubrication, deformation, thermal response and also extreme and maximum conditions. This is the only way to produce a construction with cost-optimised components that also reliably function under maximum loads and have a long service life.

Long service life with BOC (black oxide coating) and patented materials

BOC treatment of bearings prevents untimely bearing failures caused by white etching cracks (WEC). The patented special material AWS-TF (anti white structure-tough) is also available for high-level requirements and reliably prevents damage caused by WEC. Our STF material (super-tough) has proved ideal when it comes to increasing the load rating and service life, especially for contaminated lubricants. Certification by DNV GL confirms: Using Super-TF material means that the basic dynamic load rating can be improved by 23 % in roller bearings, and 26 % in ball bearings. This is equivalent to a doubling of bearing fatigue life.

MOTION & CONTROL™
NSK

NSK Deutschland GmbH

Address	Harkortstraße 15 40880 Ratingen
Phone	+49 (0)2102 481-0
Fax	+49 (0)2102 481 2151
E-Mail	info-de@nsk.com
Web	www.nskeurope.com
Category	Suppliers of mechanical components
Profile	Bearings
Turnover	Global: ~ € 6,811 mill (as per March 2020)
Employees	Global: ~ 30.700 (as per March 2020)
Founding year	1916

- 01 | Planet wheel gear and bearing
02 | Main gearbox for wind turbines
03 | Main rotor shaft bearing

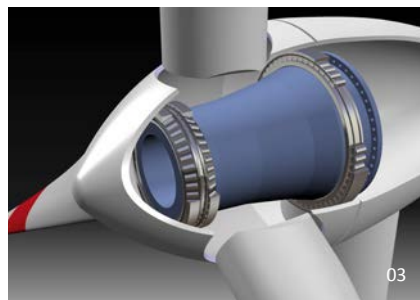

perma-tec GmbH & Co. KG

perma – The Expert in Lubrication Solutions

Wind turbines are constantly exposed to mechanical loads, vibrations and weather. To ensure reliable operation over long periods, moving components require maintenance and permanent relubrication. perma offers special lubrication systems with the right lubricants for this application.

Tried and tested a million times over: perma lubrication systems in wind turbines

perma lubrication systems reliably provide wind turbines with lubricant during operation. Components such as blade bearings, blade gear teeth, main- and yaw bearings, yaw gear teeth, and roller bearings on the generator are lubricated.

perma FUTURA PLUS – the complete system for instant use

perma FUTURA PLUS has been especially developed for use in wind turbines. It comes ready-to-use with the desired discharge period and the ideal lubricant for the respective application. Activation is started by simply turning the activation lid. perma FUTURA PLUS reliably supplies lubrication points with lubricant for up to 12 months. This saves time, extends maintenance intervals, and relieves service staff.

perma FUTURA PLUS is environmentally friendly as it can easily be disposed of after it has been emptied (no batteries included/no separate disposal required).



A further contribution to environmental protection and workplace safety is the perma DRAIN CUP. It collects the escaping used grease to avoid contamination of the rotor blades and the wind turbine. This reduces the risk of slipping accidents and avoids cleaning effort caused by lubricant contamination.

Tip: perma STAR lubrication systems are also well suited for lubrication, as they provide feedback signals visually or to higher-level controls.

Make use of the benefits of perma lubrication systems

- No manual lubrication with a grease gun
- Continuous lubrication while system is running
- Reduction in accidents due to slipping hazard → perma DRAIN CUP
- Less cleaning effort

01 | perma Lubrication systems FUTURA PLUS and STAR VARIO with STAR LC 250 as well as perma DRAIN CUP

perma lubrication systems increase the economic efficiency of wind turbines

- Reduction of maintenance costs and maintenance effort
- Fewer bearing failures

perma

perma-tec GmbH & Co. KG

Adress	Hammelburger Str. 21 97717 Euerdorf
Phone	+49 (0)9704 609-0
Fax	+49 (0)9704 609-50
E-Mail	info@perma-tec.com
Web	www.perma-tec.com/en
Category	Suppliers of mechanical components
Profile	Lubricants & lubrication systems
Turnover	€ 97.4 million (not consolidated)
Employees	269
Founding year	1934

PHOENIX CONTACT Deutschland GmbH

Inspiring Innovations

Operating in harsh environmental conditions and with their long lifecycles, wind turbines place the highest demands on electrical engineering. Phoenix Contact is a reliable partner for innovative solutions from small wind turbines to wind farms.

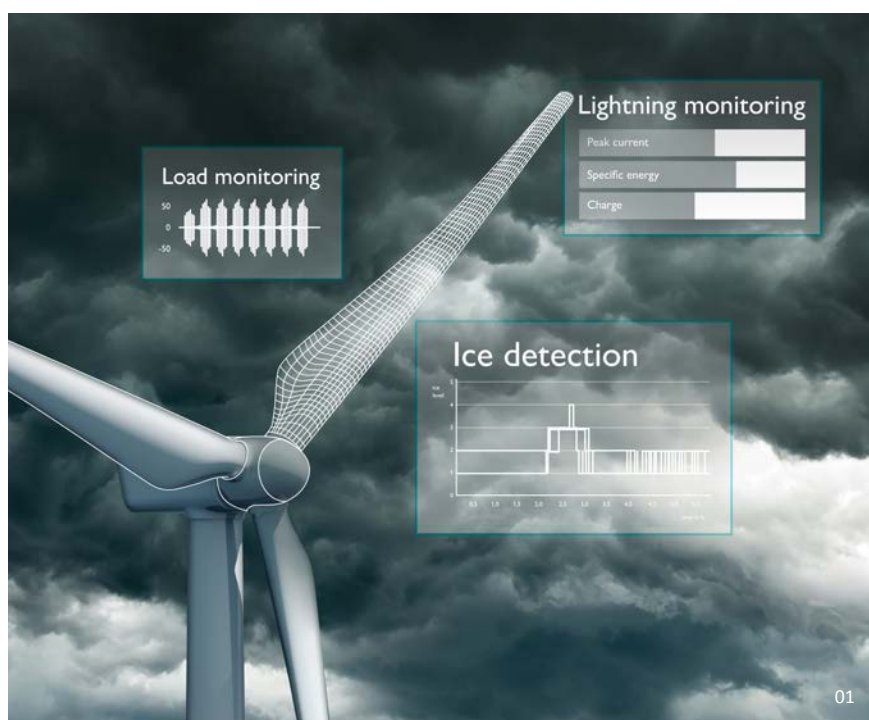

Our product range includes power supply components and system solutions including for wind and solar plant, device, and machine construction as well as control cabinet construction. We provide an innovative and diverse component range comprising modular and special-purpose terminal blocks, PCB terminal blocks and connectors, cable connection technology and installation accessories. Electronic interfaces and power supplies, Ethernet-based and wireless automation systems, safety solutions for people, machines and data, surge protection systems as well as software programmes and tools provide installers, plant operators, and device manufacturers with a comprehensive range of systems.

Phoenix Contact is supporting the digital transformation with products, systems, and solutions. Thanks to our experience in in-house mechanical engineering, we are familiar with the requirements of digitisation and the continuous flow of data, from engineering to production and beyond, along the entire product life cycle.

Product innovations and specific solutions to meet individual customer requirements are created in development departments at our locations in Germany, China, and the USA.



PHOENIX CONTACT Deutschland GmbH

Address	Flachmarktstrasse 8 32825 Blomberg
Phone	+49 (0)5235 3-120 00
Fax	+49 (0)5235 3-129 99
E-Mail	windenergy@phoenixcontact.com
Web	www.phoenixcontact.com
Category	Suppliers of electrical and electronic components
Profile	Controls, cables & switchgear cabinets
Turnover	€ 2.48 billion
Employees	17,600 (worldwide)
Founding year	1923

Phoenix Contact is the global market leader for components, systems, and solutions in the fields of electrical engineering, electronics, and automation. This family-owned company currently employs around 17,600 people worldwide and achieved a turnover of 2.48 billion euro in 2019. Our headquarters are in Blomberg, Westphalia. The Phoenix Contact Group comprises eighteen companies in Germany and more than 55 subsidiary sales companies around the world. Phoenix Contact has an international presence in over 100 countries. Global production is carried out in 11 countries with a high vertical manufacturing range.

Prysmian Kabel und Systeme GmbH

Harnessing the wind of change.

The Prysmian Group is the world's leading manufacturer for cables for the segments energy, telecom, data and industrial.

To meet an ever-growing need for power, the world is increasingly turning to renewable and sustainably-sourced energy. In response to this demand, Prysmian's cables are helping wind turbine manufacturers around the globe to harness the true potential of this natural power source.

As a world leader in special cables for wind turbines, we are able to manufacture products for the wind industry for all voltages or, if required, fully assembled cable sets in our German and international production sites:

Nacelle / Loop

Special cables (optional halogen-free / flame retardant) with increased oil, heat and ozone resistance, as well as optimized torsion properties, up to 66 kV.



02



03

Tower

Special cables (optional halogen free/ flame retardant) for fixed installation with copper or aluminium conductors with excellent installation properties, up to 66 kV.

Wind farm cabling

From the low- and medium-voltage cables for the wind farm infrastructure, through to the high-voltage grid, we supply all cables for onshore and offshore applications.

In addition, we are able to supply cables as pre-assembled cable sets, as well as a service for fitting / commissioning or maintenance / turbine monitoring.

Our certified quality management with a worldwide focus ensures that product quality is always at the highest level, from the procurement and production processes, right through to the delivery process. With a focus on sustainable and environmentally friendly production processes, the Prysmian Group ensures that the fundamental principles of sustainable energy concepts are also implemented in its own company.



04



01

- 01 | Cable laying vessel of the Prysmian Group
- 02 | Prysmian Group's product portfolio covers all your needs
- 03 | Harnessing according to customer requirements
- 04 | Production and installation from one source

Prysmian Group

Prysmian Kabel und Systeme GmbH

Address	Alt-Moabit 91 D 10559 Berlin
Phone	+49 (0)30 3675 40
Fax	+49 (0)30 3675 4571
E-Mail	kontakt@prysmiangroup.com
Web	www.prysmiangroup.de
Category	Suppliers of electrical and electronic components
Profile	Controls, cables & switchgear cabinets
Turnover	€ 11 billion
Employees	30
Founding year	1879

REWITEC GmbH

Longer Lifetime and Higher Efficiency for your Wind Turbine(s)

Our innovative REWITEC technology protects and repairs the surfaces of gears and bearings in wind turbines.



01

- 01 | View from a wind turbine
- 02 | Application on a wind turbine in Hohensolms, Dual Student Bennet Wittig
- 03 | Main bearing application GE 1.5, observation period 12 months

REWITEC, a medium-sized company based in Lahnau, was founded in 2003 and has been part of the English chemical group Croda International Plc since 2019. REWITEC develops an innovative and patented surface-treatment technology for gears and bearings, which uses nano- and microparticles, the effectiveness of which has been proven scientifically.

Based on our 12-year experience in the wind industry and having treated more than 3,000 wind turbines, we provide assistance to our customers around the world to address such issues as pitting, run through marks, downtime damage and many other risk factors that can cause wind turbine breakdowns. We offer bespoke solutions, on-site application, and pre- and post-application surface analyses.

Our technology

Our technology utilises lubricants as media to form a self-repairing silicon layer of particles on the metal surfaces of gears and bearings. This ensures greater reliability, improved energy efficiency and a long service life in so-called tribosystems by significantly reducing surface roughness, friction and temperature, which results,

among other things, in a more even load distribution on the tooth flanks and in the bearing components. The technology can be used in both oil and grease lubricated systems.

Key facts about REWITEC

- Extends the life of the lubricated component
- Repairs damaged gear surfaces within the gearbox
- Increases smooth running and reduces wear
- Proven reduction in friction, increasing efficiency
- Suitable for application in old and new wind turbine installations to extend service life



REWITEC GmbH

Address	Dr.-Hans-Wilhelmi-Weg 1 35633 Lahnau
Phone	+49 (0)6441 44599-0
Fax	+49 (0)6441 44599-25
E-Mail	rewitec.info@croda.com
Web	www.rewitec.com
Category	Suppliers of mechanical components
Profile	Lubricants & lubrication systems
Founding year	2003



02

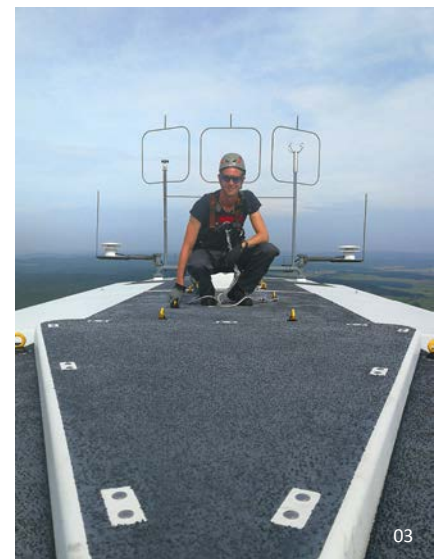

03

Rittal GmbH & Co. KG

Greater efficiency through digital transformation

Rittal offers effective solutions across the entire wind power value chain – from engineering, to production, to smart maintenance for control panels and switchgear. For over 20 years, Rittal has supplied quality products to the world’s leading systems integrators and turbine manufacturers in the wind energy industry.

Rittal GmbH & Co. KG, headquartered in Herborn, Germany, is a leading global provider of solutions for industrial enclosures, power distribution, climate control and IT infrastructure – as well as software and services.

Systems made by Rittal are deployed across a variety of industrial and IT applications, including vertical sectors such as the transport industry, power generation, mechanical and plant engineering, IT and telecommunications.

In collaboration with sister company Eplan and their smart software tools, Rittal is automating processes in switchgear engineering, manufacture, and integration that were previously manual. The result is greater efficiency in terms of both capital and operating expenditure (CapEx and OpEx) for wind turbines.

Rittal products deliver the strength, vibration resistance and corrosion protection vital to turbine dependability.

Highly robust AX compact enclosures help ensure the pitch system located in the **rotor hub** operates reliably. To shield frequency inverters and control and safety components in the turbine’s **nacelle** or **tower**, Rittal offers modular solutions based on its new VX25 large enclosure system.



The enterprise’s Blue e+ range, the world’s most efficient cooling units, provides the ideal form of climate control for enclosures. Furthermore, the IoT capabilities of these systems lay the foundations for more intelligent, more targeted maintenance.

Rittal’s modular Ri4Power system supports the configuration of low-voltage switchgear in compliance with relevant standards. In addition, options for energy storage systems range from individual enclosures to complete containerised solutions.

Rittal also offers modular edge data centres, featuring low latency and maximum security for processing data.

01 | The VX25 provides maximum flexibility and physical protection. Its digital twin comprises all relevant data, enabling efficiency gains across the entire value chain.

02 | Due to their high quality standards, solutions from Rittal can be employed in every on-shore and off-shore application.



Rittal GmbH & Co. KG

Adress	Auf dem Stützelberg 35745 Herborn
Phone	+49 (0)2772 505-2219
E-Mail	hain.f@rittal.de
Web	www.rittal.com
Category	Suppliers of electrical and electronic components
Profile	Controls, cables & switchgear cabinets
Turnover	€ 2.6 billion (2019, Friedhelm Loh Group)
Employees	9,700 worldwide (Rittal); 12,100 (Friedhelm Loh Group)
Founding year	1961

Röchling Engineering Plastics SE & Co. KG

Increased efficiency with plastic!

For the development of wind turbines, Röchling Industrial offers a broad range of composites and thermoplastics used onshore and offshore by renowned manufacturers worldwide.

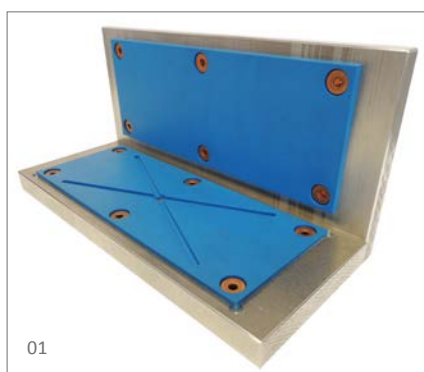

With strong wind, blade tip speeds of up to 300 km/h and strong UV radiation, wind turbines are permanently exposed to high loads. Designers are faced with the question of how a turbine can be efficient, reliable and safe to operate even under heavy loads. The potential of wind energy is enormous, but only turbines in operation make money. High efficiencies and reduced downtimes are required.

For example, pultruded **spar caps** made of carbon fibre-reinforced or glass fibre-reinforced Durostone® ensure high-performance rotor blades thanks to their strength and structure. **Sliding pads** made of tribologically optimised materials developed jointly with OEMs ensure a fast, precise alignment of the nacelle in the azimuth system. Durostone® **trailing edge serrations** support noise optimisation and efficiency thanks to their high mechanical strength and UV resistance. The range also includes machined components for drive wheels, connecting elements, cable mounts and labyrinth seals.

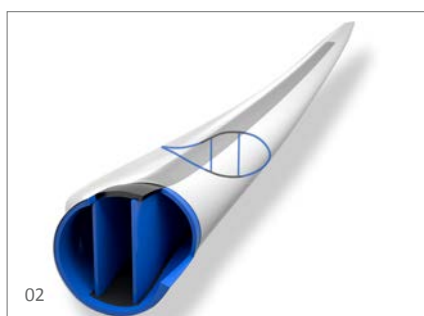

Röchling Industrial offers a comprehensive range of composites and thermoplastics. The high-performance materials help to **develop efficient and reliable systems**. Röchling products are used worldwide by well-known manufacturers in the rotor blade, tower and nacelle, and as electrical insulation parts. The goal is always to provide the designer with the ideal material for the task at hand.

Get advice now!

The specialists from Röchling Industrial also provide advice during development. With 42 locations worldwide, the Röchling Industrial offers a comprehensive range of materials and manufacturing know-how close to customers everywhere.

Röchling

Röchling Engineering Plastics SE & Co. KG

Address	Röchlingstr. 1 49733 Haren
Phone	+49 (0)5934 701-0
Fax	+49 (0)5934 701-299
E-Mail	info@roechling-plastics.com
Web	www.roechling-industrial.com
Category	Suppliers of mechanical components
Profile	Synthetic Components
Turnover	€ 847 million
Employees	3,959
Founding year	1916



- 01 | Pultruded spar caps made of carbon fibre-reinforced or glass fibre-reinforced Durostone® ensure high-performance rotor blades thanks to their high strength and structure.
- 02 | Sliding pads made of tribologically optimised materials ensure a precise alignment of the nacelle in the azimuth system
- 03 | Durostone® trailing edge serrations support noise optimisation and efficiency
- 04 | Röchling Industrial is a world leader for engineering plastics and composites in technical applications (Aerial foto of the site in Haren (Ems)/Germany)

Schraubenwerk Zerbst GmbH

Fasteners for wind turbines

We fasten your wind turbine components safely and reliably. Wind turbine and component manufacturers around the world rely on Zerbst screws and fasteners.

The Zerbst plant has been manufacturing high-quality screws and fasteners for 100 years.

Schraubenwerk Zerbst has been supplying screws made of high-quality steel to the automotive industry as early as the 1920s. At that time, 30 % of overall production was exported to the US, UK, India and the Netherlands.

Nowadays the plant in Zerbst is a highly sophisticated production plant for fasteners. In addition to an extensive product range for rail track technology, Zerbst supplies industrial screws and screw fasteners to many industries. Customers around the world from the crane industry, automotive engineering, mechanical and plant engineering, and chemical plant construction trust the Zerbst brand.

Sustainable production and sustainable business management are among the corporate principles of Schraubenwerk Zerbst GmbH. Products in the field of renewable energy and wind turbines are ideally suited to this philosophy and are a dynamically growing business segment for the company.

Tower construction: HV sets up to M72, ready for installation with preset friction coefficient

Offshore: Screw fasteners joining wind turbines to sea bed



Rotor blade: Combination of cross bolts and specially designed thermo bolts, from smaller rotor blades to over 80m long rotor blades for offshore wind turbines

Nacelle and components: Standard screws, specially designed screws and bolts in strength categories 8.8, 10.9 and 12.9

Services and logistics: From the warehouse to punctual delivery to building sites around the world.

Coatings: Galvanised and lamellar zinc coated fasteners can be supplied as standard. In addition, customers can order whatever type of coating they require.

**SCHRAUBENWERK
ZERBST GMBH** 

Schraubenwerk Zerbst GmbH

Address	Altbuchsland 22 39261 Zerbst
Phone	+49 (0)3923 713-0
Fax	+49 (0)3923 713-200
E-Mail	info@schraubenwerk.com
Web	www.schraubenwerk.de/ index_en.html
Category	Suppliers of mechanical components
Profile	Bolts & fasteners
Turnover	€ 60 million
Employees	255
Founding year	1919

SpanSet-Gruppe Deutschland

Quality and safety – made in Germany

The construction of ever more powerful and larger wind turbines increases the demands placed on grippers, cross beams, and heavy-duty round slings. Technical developments are required for secure slinging and lifting, which is what the SpanSet Group achieves in collaboration with testing institutes.



Internationally active, the SpanSet Group's core business is centred on hoisting technology, load securing, fall protection systems and safety management. Our own production facilities and sales organisations in Europe, the USA, Asia, and Australia employ around 820 people and our 22 companies based in 19 countries provide global customer services. The SpanSet Group Germany includes SpanSet GmbH & Co. KG in Übach-Palenberg, SpanSet secutex GmbH in Geilenkirchen, and SpanSet Axzion GmbH in Langenfeld. The Group holding company is based in Wollerau on the banks of Lake Zurich.

Our product range for the wind power industry reflects the product range of the entire corporate group and includes load suspension equipment produced by SpanSet Axzion GmbH, a machine and steel construction company, textile slings and load and height safety devices produced by SpanSet GmbH & Co. KG, and coatings and surface protection elements produced by SpanSet secutex GmbH. The coordinated product ranges produced by these three manufacturers can be readily combined for various applications before being deployed as a complete tested and certified operational system: this is one of the great benefits that SpanSet has to offer as a homogeneous group of companies. Our site in Neustrelitz, Mecklenburg-Vorpommern has been certified as a manufacturer of load handling equipment for offshore use by DNV GL (Norway).

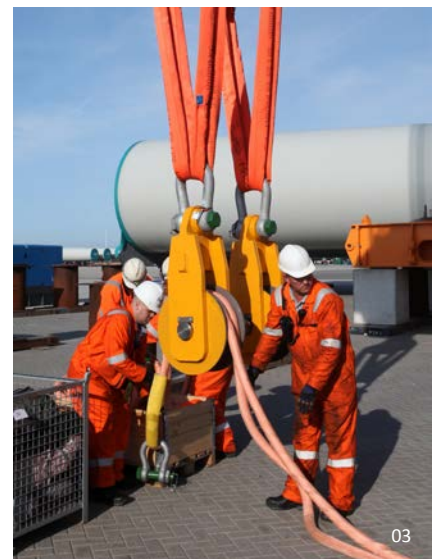

Complete solutions from a single source

SpanSet Axzion has established a seven-point programme known as Quality Seven (Q7), with which the company monitors and optimises its own performance from product development, materials procurement, drives and control technology through to production, testing, documentation and service delivery. Over 80 percent of all products we deliver are bespoke modifications. One of our prime areas of focus is on special solutions for the transportation and assembly of wind turbines.

Upending Tool – all in hand

The “Upending Tool” for lifting and erecting monopiles is one of the products frequently used in this environment. With its six tongs, its three-arm grab can lift up to 1500 tonnes. Whilst the tool’s basic construction always remains the same, Axzion makes project-specific adjustments according to the customer’s specification.

Tower Tool Kit – perfectly matched

The “Tower Tool Kit” components for lifting and erecting steel towers, which include the Magnum-X heavy-duty round sling, the pulley with turning rollers, the tower attachment point Vario-TAP, and the new Vario J-Hook XL which can lift up to 120 tonnes, all form part of the SpanSet Group’s portfolio.



04



05

Magnum-X – extremely robust and compact

The Magnum-X heavy-duty round sling, whose outstanding feature is its compact design, has a maximum load capacity of 450 tonnes. It is up to 50 percent narrower and lighter than conventional round slings thanks to a fibre core comprised of high-performance fibres and a compact hose cover, which reduces wrinkling at the load reversal point and ensures a long service life. This design principle has also opened up new areas of application. For example, the carrying pins on heavy machines are often designed for wire ropes and standard commercially available round slings are only partially suitable for use with them. The Magnum-X fits neatly into the contour of the support pins thanks to its slim design, which means they can be used together with turning rollers when lifting steel towers.



06

ClimaTech – PPE for the worst case scenario

SpanSet has designed ClimaTech especially for work on wind power plants and metrological masts. The chest and back-mounted fall arrest points mean that ClimaTech can be used both as a fall arrest harness and as a work positioning harness.



SpanSet-Gruppe Deutschland

Adress	Winkelsweg 172 40764 Langenfeld
Phone	+49 (0)800 299 466 457
Fax	+49 (0)2173 20 89228
E-Mail	info@axzion.de
Web	www.axzion.de
Category	Suppliers of mechanical components
Profile	Tools & machine tools
Turnover	> € 50 million
Employees	330
Founding year	1966

STEGO Elektrotechnik GmbH

Enclosure Climatisation. Perfect.

STEGO heating elements, regulators, fans, lamps and accessories protect your sensitive electronic components against harmful climatic influences.



01

- 01 | STEGO Headquarters in Schwaebisch Hall
- 02 | Semiconductor Fan Heater CSL 028
- 03 | Electronic Hygrotherm ETF 012

STEGO products are used in all places where sensitive electronic components must be protected from humidity and other climatic influences. Heating elements, regulators, fans and STEGO accessories help you to optimise operating conditions and to reach maximum protection for your installations. So that you can be sure of lasting success!

Perfect thermal management.

Since it was founded in 1980, STEGO Elektrotechnik in Schwäbisch Hall, Germany, has been developing, producing and selling an ever-growing range of products for the protection of electric and electronic components. All STEGO products are aimed at reaching optimum climatic conditions in the most varied environments, ensuring that all sensitive components work reliably at all times.

Tried and tested temperature and humidity control systems ensure these optimised climatic conditions. If temperature and/or humidity are too low or too high, the necessary countermeasure is immediately initiated, for example a heater is turned on or a filter fan circulates cool air. A diversity of conditions such as the change from day to night, or particularly warm or cold regions, make climatisation an ever-increasing and challenging task. To meet this challenge, STEGO offers everything that is needed to protect sensitive components from corrosion and malfunction.

Worldwide service supporting quality worldwide.

STEGO's thermal management solutions are exported internationally and find use in the most diverse areas of application and climatic conditions.



STEGO Elektrotechnik GmbH

Address	Kolpingstrasse 21 74523 Schwaebisch Hall
Phone	+49 (0)791 95058 0
Fax	+49 (0)791 95058 45
E-Mail	info@stego.de
Web	www.stego.de
Category	Suppliers of electrical and electronic components
Profile	Cooling & climatisation
Founding year	1980



02



03

TECHNO-PARTS GmbH

Innovative sealing systems and moulded parts for modern technology.

In sealing technology, the smallest details are critical for reliable functioning. Our products have been doing their job reliably for years, from the tried-and-tested to the innovative component.

Over 50 years of experience in the sealing field for hydraulics, pneumatics, chemicals and plant engineering have made us a high-performance company. We cover almost all applications – from miniature pneumatics to heavy-duty hydraulics, from chemicals and plant construction to offshore wind turbines. We continuously put our experience to work in the development and optimisation of our growing product range.

Our staff's wide-ranging expertise ensures a comprehensive service – from technical advice to our customers on-site to flexible order handling and on-time delivery.

A warehouse with well over 20,000 different items and flexible production for machined and injection-moulded products, combined with in-house toolmaking, enable us to meet most customer requests in the shortest possible time.

A well-equipped laboratory for physical and chemical testing, comprehensive experiments and certification in accordance with DIN EN ISO 9001 make a significant contribution to our high quality standards and the further development of our products.

Individual packaging is just as much a part of our services as our own eKanban system and a quick service for urgent repairs and prototypes.

For the special requirements of wind turbines, we also supply radial shaft seals with high-strength, fabric-reinforced elastomer backs and excellent sliding properties. The shaft seals are available for internal and external sealing, also in split design with diameters up to 4,000 mm. This facilitates repairs and alleviates difficult installation conditions.



- 01 | Shaft seals for wind turbines and for heavy machine construction
- 02 | Most modern storage technology and more than 20,000 different articles in stock
- 03 | Headquarter in Essen



TECHNO PARTS
Dichtungs- und Kunststofftechnik
 Sealing and Plastics Technology

TECHNO-PARTS GmbH

Adress	Alte Bottroper Straße 81 45356 Essen
Phone	+49 (0)201 86606-0
Fax	+49 (0)201 86606-68
E-Mail	vk@techno-parts.de
Web	www.techno-parts.de
Category	Suppliers of mechanical components
Profile	Seals & vibration control
Founding year	1981

TOTAL Deutschland GmbH

Committed to Better Energy

As a key actor in the energy sector, the Total Group has been working to effectively reduce the greenhouse gas emissions linked to its activities for many years. The energy company aims to be CO₂-neutral by 2050.



The company is equally keen to work proactively with industry players and the international community to find solutions to tomorrow's challenges and issues.

TOTAL AS A PRODUCER OF WIND ENERGY

Our subsidiary Total Eren (in which we hold a 26.9 % stake), gives the Group a diverse network of wind, solar and hydroelectric power stations spread across Asia, Africa, and Latin America. This enables us to develop projects in regions where renewable energies are a particularly suitable and sustainable solution to the burgeoning energy demand. Thanks to its unique track record in developing new projects in new geographic locations, Total Eren currently has a renewable energy generation capacity in excess of 3300 MW*, of which the gross installed wind

power capacity is 795.5 MW. Projects with a total rated output of 2,000 MW* (of which wind energy accounts for 610.7 MW) are currently being developed and implemented in more than five continents.

The group is consistently pursuing the development of a portfolio of low-carbon electricity production businesses with the objective of generating 15 to 20 % of total sales from them by 2040. Within the wind energy sector, the Total Group already has a total installed capacity of 1.4 GW* through its subsidiary Total Quadran and our stake in Total Eren. We are continuing to expand our wind power generation capacities and are currently implementing wind power projects with a total rated output of 2.5 GW* (*as of late 2019).

TOTAL AS A WIND ENERGY LUBRICANT SUPPLIER

Both wind turbine manufacturers and wind farm owners are currently trying to lower equipment and operating costs, a development which is also affecting the lubricants they use. Increasingly more powerful wind turbines require the latest, high-performance lubricants that can withstand high loads and enable lengthy replacement intervals, which reduces service costs.

Total is a reliable wind industry partner and provides a complete range of wind turbine lubricants, from gear oils to greases and hydraulic oils approved by the major manufacturers. Our customer-oriented service also helps to maximise the energy efficiency of wind turbines, avoid unscheduled downtime, and reduce maintenance costs.

Wind concept Plus from Total

Total is committed to taking a holistic view of developments in the renewable energies field and to their continuous improvement. The Wind Concept Plus plan is based on three important, correlated pillars:

INNOVATION AND SPECIALISATION.

Total not only wants to push forward innovation in the form of new lubricants for industrial customers, but also to take full advantage of the potential of new developments.

CUSTOMER SATISFACTION.

Total provides high-quality lubricants and places equal importance on excellent service. Total customers benefit from professional advice from competent application engineers as well as value-added services, which include the rationalisation and organisation of lubrication tasks, maintenance, laboratory analyses of operating fluids as well as lubricant training for employees.

HIGH PERFORMANCE PRODUCTS WITH A LONG SERVICE LIFE.

Our high-performance CARTER WT 320 gear oil, a PAO-based product that provides excellent protection against micro-pitting in gear trains and guarantees an extension of the replacement intervals of up to 10 years is an excellent example. Its high viscosity index results in improved characteristics at extremely low temperatures and specifically reduces wind turbine downtime.

Oil monitoring by ANAC Wind

Total has more than 40 years of oil analysis experience in all areas and also ensures the monitoring of around 500,000 components.

The proper operation of a wind turbine depends strongly on the performance of the reduction gear unit, which requires special monitoring due to the harsh operating conditions.

Total's ANAC Wind provides wind turbines operators with the means to monitor the oil properties and determine the origin of potential pollutants. ANAC Wind provides support for the maintenance strategy by optimising oil change intervals and reducing downtime and the associated maintenance costs as well as optimising wind turbine maintenance planning.

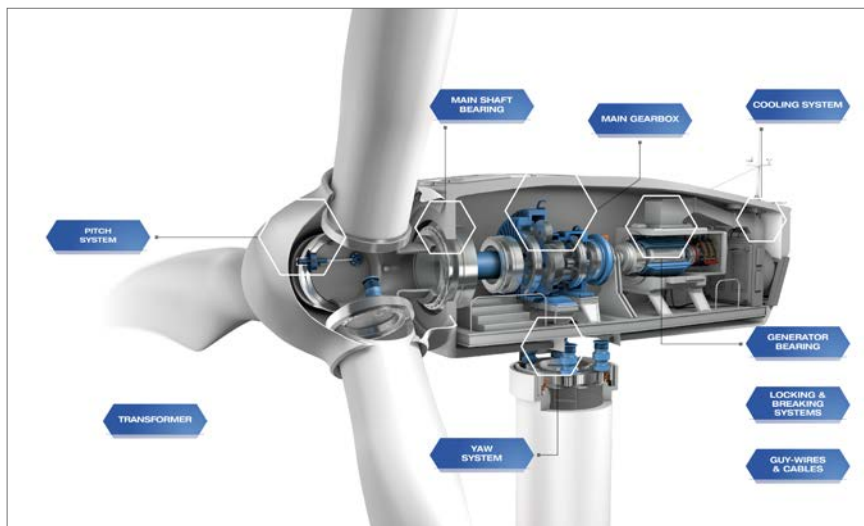

TOTAL lubricants for every component of a wind turbine.



TOTAL Deutschland GmbH

Adress	Jean-Monnet-Str. 2 10557 Berlin
Phone	+49 (0)30 202 76 787
Fax	+49 (0)30 202 77 96 634
E-Mail	rm.industrie@total.de
Web	www.total.de/industrie
Category	Suppliers of mechanical components
Profile	Lubricants & lubrication systems
Turnover	€ 15 billion
Employees	4,000
Founding year	1955

Weidmüller Group

Weidmüller – Partner in Industrial Connectivity

Nowadays, the wind industry energy sector is faced with the challenge of meeting growing profitability requirements. Weidmüller meets this demand with reliable components and customized solutions to reduce the investment and operating costs.



01

- 01 | BLADEcontrol®
- 02 | LED Solution
- 03 | Customer specific assembly
- 04 | Weidmüller Wind

Weidmüller – Partner in Industrial Connectivity

As experienced experts, we support our customers and partners around the world with products, solutions and services in the industrial environment of energy, signals and data.

We are at home in your industries and markets and know the technological challenges of tomorrow.

In this way, we continually develop innovative, sustainable and value-added solutions for your individual requirements. Together we set benchmarks in industrial connectivity.

Wind Solutions

Operate your wind turbines more efficiently with our tailored solutions for maximum profitability.

Whether it's optimizing the yield, reducing the LCOE or extending the life time of the system. Weidmüller meets these requirements with tailor-made solutions, global presence as well as a wealth of experience and a successful track record.

Besides modular LED system solutions, the automation and connection technology, it is our monitoring systems and data-driven business models that lead your wind turbine sustainably into the future.

Weidmüller product highlights for Wind:

- Rotor blade monitoring with BLADEcontrol®
- Condition monitoring for screw connections
- LED solutions for tower and nacelle
- Customer specific assemblies

Weidmüller is international – we have six manufacturing plants, 31 sales companies and more than 60 representations all around the world.

In financial year 2019 Weidmüller generated sales of 830 Mio. € with around 5,000 employees.

Let's connect.

Weidmüller

Weidmüller Group

Address	Klingenbergstraße 26 32758 Detmold
Phone	+49 (0)5231 14291229
Fax	+49 (0)5231 1428 116
E-Mail	Hans.Schlingmann@weidmueller.com
Web	www.weidmueller.com/int/solutions/wind_solutions/index.jsp
Category	Suppliers of electrical and electronic components
Profile	Condition monitoring systems
Turnover	€ 830 million
Employees	5,000



02



03



04

Weitkowitz GmbH

Always a safe connection. Guaranteed!

Weitkowitz has been manufacturing and supplying cable terminals, connectors, ferrules, cable ties, pressing and cutting tools for over 100 years. We'd be glad to collaborate with you to develop special wind solutions.

Weitkowitz GmbH has stood for quality products in the electrical sector for decades. Our "WM press-fit geometry", which was originally developed by Franz Weitkowitz, personifies our claim to quality, functionality and the longevity of all our products and services, which is as valid today as it always has been.

Our slogan "A secure connection guaranteed!" is a promise that reputable clients from all over the world rely on every day. Of course, our company is also ISO9001 and ISO ITS16949 certified and, therefore, meets the highest quality requirements for various sectors including the automotive industry.

Clients from the fields of electrical installation, switchgear and transformer construction, cable assembly, lightning protection, railway engineering, wind energy and photovoltaics have been successfully using Weitkowitz products in their products and systems for many years.

Special solutions, such as our rectangular cable terminals and connectors, offer protection from such things as the chamfering of surge arresters.

Press-fit and screw connectors allow for the quick and easy installation of cable harnesses when setting up wind-energy turbines.

Talk to us and let us know your requirements: we'll be happy to work with you to find the perfect solution for your specific needs.



01

- 01 | rectangle cable lugs and connectors, connectors for wind applications
- 02 | hydraulic press head APW 18
- 03 | equipment for wind turbines
- 04 | view over the company



02



03



04

WEITKOWITZ
intercable group

Weitkowitz GmbH

Adress	Woltorfer Straße 125 31224 Peine
Phone	+49 (0)5171 70610
E-Mail	info@weitkowitz.de
Web	www.weitkowitz.de
Category	Suppliers of electrical and electronic components
Profile	Energy & data transmission
Turnover	€ 24 million
Employees	170
Founding year	1918

Wieland Electric GmbH

Safe Solutions for the wind tower – from engineering to service

Wieland Electric supports manufacturers of wind turbines, tower builders and wind park operators with sophisticated products and customized concepts for light and energy distribution in the tower.



- 01 | Podis® LED – In tubular steel towers, luminaires can be fastened to the tower wall directly using magnets or to the cable basket tray using quick-mounting plates without the use of tools.
- 02 | Thanks to a pluggable system, sockets of various designs can be placed anywhere in the tower.
- 03 | Our IIoT and remote maintenance solutions provide a user-friendly and secure communication for your plant – today and in the future.

The pluggability and modular design of the system components allow extremely short planning and installation time, flexible assembly options and the highest availability.

For reliable tower lighting, Wieland Electric offers robust and low-maintenance LED lights as plug & play components that can be installed quickly and efficiently in the course of a well thought-out mounting system. They can be mounted without tools using quick mounting plates on the grid cable duct or in steel towers with magnets directly on the tower wall. In the event of a power failure, a battery-backed UPS supplies the lighting with energy and ensures that personnel can descend safely.

With the Podis® flat cable system and the RST® round cable system, two innovative solutions for flexible infrastructure cabling are available. Whether lighting, maintenance sockets, control cabinet or service lift - all wind turbine components can be quickly, safely and error-free plugged together in the factory or on the construction site. This can reduce installation times by up to 70 %.

To avoid system failures, secure data communication and reliable control technology are essential. Data transmission even over long distances is possible by means of robust switches that can be expanded with fiber optic converters. In addition, reliable IIoT and remote maintenance components ensure a secure communication link for the plant and make service assignments easier to plan.



Wieland Electric GmbH

Address	Brennerstraße 10–14 96052 Bamberg
Phone	+49 (0)951 9324-0
Fax	+49 (0)951 9324-198
E-Mail	info@wieland-electric.com
Web	www.wieland-electric.com
Category	Suppliers of electrical and electronic components
Profile	Light fittings & emergency light fittings
Founding year	1910



Winergy

Flender GmbH

With 40 years of experience, Winergy offers gearboxes and generators for on- and offshore application up to 20 MW. This is complemented by comprehensive service offerings. Winergy sites are in Europe, China, India, and the U.S., while the base of service locations is continuously being expanded.

Reliability is the foundation of a long-term partnership

In 1981, Winergy started to manufacture gearboxes specifically designed for wind turbines. To date Winergy has supplied over 175 GW of gearbox capacity and more than 50.000 generators. Reliable, efficient and at low lifecycle costs Winergy components ensure that wind turbines all over the world convert windpower into electrical energy.

To support your customers globally – you must be represented locally

Since Winergy's foundation, we have successfully implemented a globalization strategy and today operate production facilities in Europe, USA, China and India. Apart from that Winergy is continuously expanding their service locations for example in Australia, Japan and Brazil.



02

Quality is more than just a word to us – it is the essence of our products

The quality that we demand from our products is also reflected in our processes. Our customers all around the world benefit from our high-quality products and short delivery times. This is achieved with our comprehensive and fully integrated process management, lean operation and zero defect tolerance.

Our drive train components are as unique as your requirements

Detailed wind turbine specification is the foundation of individual drive train development. Winergy takes its long-term experience into account to develop cost-effective solutions that perfectly fulfill customer requirements. The result: mechanical components which increase energy efficiency.

Reliable service solutions

We have service concepts that are individually tailored to the requirements of our customers. The objective is to ensure high availability of your systems, resulting in reduced operating costs.



03



01

- 01 | Broad service portfolio including uptower services
- 02 | Production process according to VDA-6.3. quality standards
- 03 | Winergy gearboxes



Winergy

Address	Am Industriepark 2 46562 Voerde
Phone	+49 (0)2871 92-4
Fax	+49 (0)2871 92-2487
E-Mail	info@winergy-group.com
Web	www.winergy-group.com
Category	Suppliers of mechanical components
Profile	Gears and generators
Founding year	1981



Enertrag service technician performing maintenance on an Enercon E-66 in Nechlin.
Photo: Enertrag/Silke Reents

An aerial photograph showing a large white wind turbine tower and nacelle. The tower is on the left, and the nacelle extends diagonally across the upper right portion of the image. Below the tower, three vehicles (two white vans and one dark car) are parked on a grassy area. The surrounding landscape is a green field with some circular tracks or paths. The overall scene is captured from a high angle, looking down at the turbine and the ground.

COMPANIES:

Service & logistics

Planning, finance, transport, construction and marketing. The fields of planning and operation of wind turbines are a continuous growth market in Germany.

ABO Wind AG

Full Service Provider for Wind Farm Development, Construction & Maintenance

ABO Wind is one of Germany’s renowned wind energy specialists, offering the full range of wind farm development, financing, construction and grid connection. The company also provides operational management, services and technical solutions for an optimised output.



- 01 | Skilled technicians repair a gearbox at ABO Wind’s central warehouse.
- 02 | Our technical service team provides inspections and repairs of wind farms and large components.
- 03 | The control room monitors renewable energy plants across Europe.

25 Years of Wind Energy Expertise

Since 1996 ABO Wind has developed and sold renewable energy projects with a total capacity of 3,000 megawatts. The company has also built and delivered around half of these as turnkey projects. Currently, more than 700 committed employees are working on the development of new wind and solar farms with a total output of around twelve gigawatts worldwide.

Project Development and Repowering

ABO Wind initiates wind and solar energy projects, acquires land or existing projects, carries out all technical and commercial planning and engineering, prepares bank financing and builds the plants on a turnkey basis. Among municipalities, landowners and energy cooperatives, ABO Wind is known as a fair and reliable partner.

Operational Management & Technical Services

Remote monitoring, on-site service, contract management, and accounting: Our flexible modules offer the perfect fit for each wind farm. In addition, experienced engineers develop smart solutions such as the access control “ABO Lock”, which allows operators to digitally control and log access to their wind farms. ABO Wind also offers maintenance, repair, safety checks, inspections and troubleshooting from a single source.

Large Components

Our technical experts assess all major plant components including foundation, tower, drive train and rotor blade. When needed, our technicians replace and repair gearboxes, generators and main bearings.



ABO Wind AG

Address	Unter den Eichen 7 65195 Wiesbaden
Phone	+49 (0)611 267 65-0
Fax	+49 (0)611 267 65-599
E-Mail	kontakt@abo-wind.de
Web	www.abo-wind.de
Category	Planning
Profile	Planers & project developers
Turnover	€ 500 million (project volume)
Employees	700
Founding year	1996



BDO Oldenburg GmbH & Co. KG Wirtschaftsprüfungsgesellschaft

Your partner for the renewable energy sector

Our team of industry experts is your perfect partner for wind energy company and project consulting in relation to auditing, tax consulting, legal advice, corporate finance and IT.

The BDO Oldenburg GmbH & Co. KG Wirtschaftsprüfungsgesellschaft has regional roots, a strong national presence, and excellent international networks. Our team currently employs 100 qualified staff members in Oldenburg. Almost 1900 BDO employees at 27 locations throughout Germany are available as partners for the corporate success of our clients.

We have been actively supporting and helping to shape the rise of the renewable energy sector since the early nineties. We are a founding member of the Oldenburger Energiecluster OLEC e.V., which operates on a nationwide basis, and are a member of the relevant industry associations within the Bundesverband Erneuerbare Energien e.V. (BEE e.V.).

We use these strong networks with qualified partners as well as our collaboration with our colleagues from the BDO AG Wirtschaftsprüfungsgesellschaft to combine various strands of knowledge and guarantee our clients a broad spectrum of industry knowledge. We have been organising the "Renewable Energies" forum in Oldenburg with top-class external speakers for many years.



01

Our main consultancy areas include:

- conception and participation/financing concept structuring, in particular in collaboration with citizen energy societies,
- business plans, profitability analyses, financial modeling,
- sale prospectus (VermAnlG, KAGB and WpPG) preparation, investment information sheets (VIB) for crowd investing,
- support for BaFin proceedings,
- company valuations (IDW S1/S10),
- due diligence reviews (tax, financial, legal),
- transaction advice,
- yield certificates for extended initial remuneration,
- complex tax declarations for investment companies, and
- annual financial statement audits in compliance with specific VermAnlG regulations.



BDO Oldenburg GmbH & Co. KG Wirtschaftsprüfungsgesellschaft

Adress	Moslestraße 3 26122 Oldenburg
Phone	+49 (0)441 980 50 0
Fax	+49 (0)441 980 50 180
E-Mail	erneuerbare@bdo-oldenburg.de
Web	www.bdo-oldenburg.de
Category	Finance & Law
Profile	Tax accountants
Founding year	1995

BIL eG

Double benefit for the wind energy sector

Germany’s nationwide information system for pipeline inquiries, BIL, provides a centralized inquiry portal for those carrying out construction activities and for operators of wind power plants. Some 380,000 inquiries coming from nearly 28,000 users have been successfully processed by the BIL portal.



Status September 2020

In response to online user inquiries, the BIL process returns a positive and negative list. The relevant operators are automatically identified by the query process. The remaining inquiries will not reach the pipeline operators, significantly reducing the time and effort spent processing irrelevant inquiries. This marked reduction in negative responses that need to be issued makes the BIL fee well worthwhile even for small grid operators. BIL offers a special set of fees tailored to the wind power sector.

BIL is an initiative of pipeline operators in Germany organized as a cooperative and the first to provide an online inquiry portal free of charge in Germany. Its goal is to increase the safety of pipeline networks by establishing a single point of entry for inquiries. To date, nearly 100 companies participate in the BIL portal.

For more information, please visit www.bil-leitungsauskunft.de



BIL eG

Address	Josef-Wirmer-Str. 1–3 53123 Bonn
Phone	+49 (0)228 92 58 52 90
E-Mail	info@bil-leitungsauskunft.de
Web	www.bil-leitungsauskunft.de
Category	Operation & Service
Profile	Service, maintenance & repair
Turnover	€ 1.2 million
Employees	5
Founding year	2015

By participating in the BIL process, operators of wind power plants can significantly improve the safety of their grid feed-in. Since the topographic distance between the generating plant and the feeding point is often long, it is particularly important for pipeline operators to be clearly identified by those pursuing construction activities in order to avoid pipeline damage. Especially smaller and unknown operators benefit from the high volume of requests to the BIL portal and it gives them a better overview of the construction activities planned in the area of their pipeline infrastructure.

01 | BIL Effect
02 | Inquiry area wind power



Centrica Energy Trading GmbH

We move and trade energy to satisfy the changing needs of customers worldwide

Centrica Energy Trading (former Neas Energy) is since its acquisition of Centrica plc a part of Centrica’s Energy Marketing & Trading (EM&T) business unit.

We trade gas, power, and LNG and provide the route to market for our upstream and power generation operations. Around 600 people work in Centrica EM&T in our offices in Denmark, the UK, Germany, Sweden, Norway, and Singapore.

Centrica EM&T’s headquarters are in London. Our trading floor is located in Aalborg, Denmark and our German subsidiary is seated in Hamburg, Germany.

Centrica Energy Trading is one of the leading energy service companies in Europe. We provide our clients with the best route-to-market services available to the market today, integrating sophisticated software, trading and structuring and optimizing exposures all the way from long term risk management down to physical trading seconds before delivery.

Our trading floor in Aalborg, Denmark, works 24/7 and a team of traders is supporting the European nightshift from our trading office in Singapore.

Our services

Direktvermarktung and the marketing of Post-EEG assets, as well as power purchase agreements (PPAs), are our key competences on the German market. Centrica has over 15 years of experience from the PPA business in the Nordic countries where deals with complex structures are part of our day-to-day business.

Currently, Centrica Energy Trading manages a power generation portfolio in Europe of more than 14,2 GW.

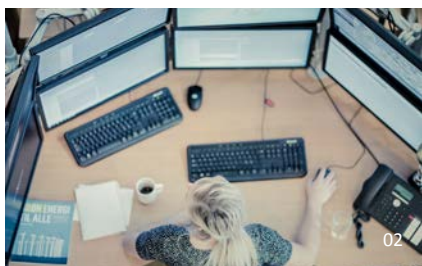

01 | Windpark
02 | Traderoom, CET
03 | Traderoom, CET
04 | Solarpark



Centrica Energy Trading GmbH

Adress	Gustav-Mahler-Platz 1 20354 20354 Hamburg
Phone	+49 (0)40 228 676 950
Fax	+49 (0)40 228 676 958
E-Mail	energytrading@centrica.com
Web	www.centricaenergytrading.com
Category	Direct marketing
Profile	Direct marketers
Employees	300 (Wind energy: 30)
Founding year	1998

Connected Wind Services Deutschland GmbH

Service & Maintenance – Complex Service Projects – Up-tower Repairs – Spare Parts
 Connected Wind Services. One of the leading independent service provider in the global renewable energy market.



01

Dedicated to advancing the transition to sustainable energy, we challenge the current service solutions and explore new, innovative ways to reduce complexity and optimize the operation of wind turbines by combining our vast knowledge and experience with progressive thinking.

Always observant and understanding of individual client needs, we tailor solutions and service concepts to reduce downtime and ensure longevity, maximum yield and protection of assets and resources.

- 01 | Connected Wind Services – Advancing your future movement
- 02 | Rest assured, we maintain the highest level of safety with committed technicians who possess the highest GWO training standards
- 03 | More than 50 service teams take care of your concerns
- 04 | Service & Maintenance

Connected Wind Services. We are a global independent service provider with +30 years of experience dedicated to advancing the movement of wind assets, businesses and society in a connected world.

For the benefit of us all. We believe pioneering people to be the driving force behind positive change. And we aim to do our part in supporting their mission. With a local presence and trust and transparency as our guiding principles, our clients can rely on us as the professional partner, that makes their obstacles disappear and keeps them moving forward.



Connected Wind Services Deutschland GmbH

Adress	Mühlenberg 19 25873 Rantrum
Phone	+49 (0)4848 90 128-0
Fax	+49 (0)4848 90 128-22
E-Mail	info.de@connectedwind.com
Web	www.connectedwind.com
Category	Operation & Service
Profile	Service, maintenance & repair
Turnover	€ 9.8 million in Germany / 29 million on group level
Employees	75+ in Germany / 170+ on group level
Founding year	1987



02



03



04

cp.max Rotortechnik GmbH & Co. KG

Maximizing rotor performance has been our main goal for over 20 years. During this time, we have played a key role in shaping the service for rotor blades and continuously developed new solutions for repair and optimization.

When the rotor blades of wind turbines (WTs) were still around 20 meters long, cp.max also started out very small. Right from the start, however, we revitalized the industry with a small revolution: the introduction of rope access technology. Today it is an integral part of the work on wind turbines.

And in the years that followed, we continued to develop our skills. We offer our range of services worldwide. At its core it currently comprises:

- Inspection and repair of rotor blades of all (blade- and turbine-) types
- Flexible, cost- and time-saving rope access and access using work platforms
- Drone inspections
- Customer-oriented planning with a personal contact
- Certified repair procedures for difficult weather conditions, for example in winter
- Balancing the rotor to prevent damage and increase yield



03

- Aerodynamic investigation of the rotor and installation of adapted flow elements based on this
- Training courses on the inspection, repair and manufacture of rotor blades

Team player

Thanks to our close and trusting contact with well-known designers, as well as manufacturers of rotor blades and wind turbines, we have background knowledge that goes beyond what is customary in the industry. In this way we can, for example, draw connections between damage, manufacturing errors or problems in the design of rotor blades. This contributes significantly to an optimally adapted repair.

For over 20 years cp.max Rotortechnik has stood for a balanced combination of experience and innovation with consistently excellent quality.



02



04



01

- 01 | Rope access is flexible, time-saving and cost effective
- 02 | Our workers are well trained to maximize the performance of every turbine
- 03 | View from above the clouds
- 04 | We research and develop on the most exciting topics in wind energy



cp.max Rotortechnik GmbH & Co. KG

Adress	Manfred-von-Ardenne-Ring 5 01099 Dresden
Phone	+49 (0)351 858 934 50
Fax	+49 (0)351 858 934 577
E-Mail	info@cpmax.com
Web	www.cpmax.com
Category	Operation & Service
Profile	Service, maintenance & repair
Employees	60+
Founding year	1997

Deutsche Windtechnik AG

Independent full scope O&M provider for multibrand WTG technologies on-/offshore

Deutsche Windtechnik is an independent specialist in the technical maintenance of wind turbines. Over 1,600 employees ensure that the wind turbines operate reliably around the clock, with the focus on Vestas, Siemens, Nordex, Senvion, Fuhrländer, Gamesa and Enercon turbines.



- 01 | More than 400 service teams operate for Deutsche Windtechnik internationally.
- 02 | Deutsche Windtechnik offers the complete service for offshore wind farms as well from foundation, to turbine, to blade, to offshore substation.
- 03 | Our day-to-day business includes the planning and implementation of maintenance, repair, upgrading and inspection procedures.



Deutsche Windtechnik AG

Address	Stephanitorsbollwerk 1 (Haus LEE) 28217 Bremen
Phone	+49 (0)421 69105 0
Fax	+49 (0)421 69105 499
E-Mail	info@deutsche-windtechnik.com
Web	www.deutsche-windtechnik.com
Category	Operation & Service
Profile	Service, maintenance & repair
Turnover	€ 165 million (in 2019)
Employees	1,600
Founding year	2004

Comprehensive expertise, flexibility and more value for lower costs – this is what sets apart the quality of our service. With our diverse range of core competencies, we are able to offer the full package of services from a single source. We now service over 5,500 wind turbines as part of permanent maintenance contracts (basic maintenance and full service). Our objectives are to ensure technical systems operation and to carry out our work in the most cost-efficient way possible.

Independent O&M worldwide

Our decentralised service network enables us to move swiftly between the customer, the wind turbine and spare parts warehouses. Our company’s head office is based in Bremen, Germany. In addition, Deutsche Windtechnik is also active abroad: locations in Denmark, France, The Netherlands, Poland, Sweden, Spain, Taiwan, United Kingdom and the United States provide the foundation for high-quality system maintenance around the world.

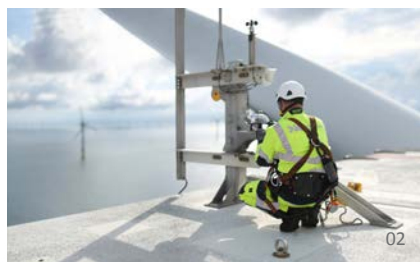

Full scope from A to Z

Whether it is the entire wind turbine, the control system, nacelle, rotor or the foundation, from large components to the smallest electronic components or even the substation, our team of experts understands your wind turbine portfolio and can provide economic benefits from a service point of view. Onshore and offshore.

Our range of services includes:

- Individual, needs-based and modular service offering from the basic service to the full maintenance contract, which also covers external damage including major components.
- Repair and optimization
- Control and power electronics
- Expert appraisals for a range of scenarios
- QHSE and project support
- Offshore operations management
- Repowering Development and sale of spare parts

All services are freely combinable.

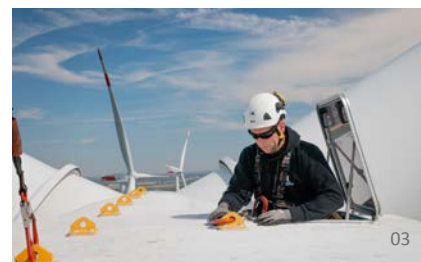

Dunoair Windpark Planung GmbH

The energy transition comes first

As a specialist for the planning, construction and management of sites for wind turbines in Germany and abroad, DunoAir promotes climate and environmental protection.

We are a family-oriented company and safeguarding the future for the generations to come is important to us. The energy transition is an important move towards a time when access to energy is clean, inexhaustible and affordable. This goal strengthens our resolve every day to commit ourselves to wind power.

DunoAir originally began with Arjen C. F. Ploeg as a project buyer. The company developed dynamically in the years that followed and successfully established itself on the market. With the creation of its own planning department in 2009, DunoAir Windpark Planung GmbH, we have finally become a successful full-service company covering the entire value chain. From planning and construction to operation, DunoAir covers all the relevant fields for implementing projects in a serious, prompt and reliable manner.

Qualified and motivated staff are particularly important. They are the reason that DunoAir was able to grow into an international company with offices in Germany, the Netherlands and Ireland, and with projects boasting a total installed capacity of about 220 MW.

Communities and local companies are closely involved in project development and are kept regularly up-to-date. Transparency like this creates trust and forms the basis for good and sustainable collaboration, with a view to adding value at a regional level.

The DunoAir team looks forward to giving investors, planners and operators the benefit of its expertise. Contact us and discover a reliable partner for the successful implementation of your projects.



- 01 | Relaxed into the future looking – Wind farm festival in Weibern-Rieden
- 02 | Company founder Arjen C. F. Ploeg
- 03 | Assembly of a nacelle in the wind farm Dahlem-Baasemer Wald



Dunoair Windpark Planung GmbH

Adress	Hawstraße 2a 54290 Trier
Phone	+49 (0)651 99 98 89-13
Fax	+49 (0)651 9998 8999
E-Mail	c.wuertz@dunoair.com
Web	www.dunoair.com/en
Category	Planning
Profile	Planers & project developers
Employees	12
Founding year	2004

ELPRESS GmbH

Elpress – we make secure connections!

The business aim of the Elpress Group is to provide, primarily to professional users, qualified material and knowledge concerning electrical applications, with a high level of service and product expertise.



01



02



03



04

Elpress has been developing, manufacturing and marketing complete cable crimping systems for electrical connectors since 1959. The Elpress Group, consisting of Elpress and ABIKO business areas, is owned by Lagercrantz Group AB. Elpress head office, factory and warehouse are located in Kramfors, Sweden.

- 01 | Elpress products from base to blade
- 02 | Elpress – Solutions for Renewable Energy
- 03 | System ELPRESS - Certification, Consulting, Academy, Service
- 04 | 60 Years Of Experience



ELPRESS GmbH

Address	Kränkelsweg 24 41748 Viersen
Phone	+49 (0)2162 9319-0
Fax	+49 (0)2162 350403
E-Mail	info@elpress.de
Web	www.elpress.de
Category	Operation & Service
Profile	Service, maintenance & repair
Turnover	€ 40 million
Employees	160 (Wind energy: 30)
Founding year	1959

Subsidiaries Elpress GmbH (DE), Elpress A/S (DK), Elpress AS (N), Elpress (CHN) Ltd. and Elpress Inc. (USA) with local warehouses in Silkeborg/Denmark, Beijing/China and Chicago/USA. In total, around 160 people work in the Elpress Group. Elpress group is doing sales in more than 70 countries all over the world.

EMD Deutschland GbR

windPRO, windOPS, energyPRO – Training and Support

EMD Deutschland is the exclusive sales agency and training provider of EMD International A/S for central europe, the balkan states and the German speaking countries.



windPRO – software for wind energy project design and planning

windPRO is a module-based software package suited for project design and planning of wind farms and photovoltaic power plants. windPRO covers different areas, from energy yield calculations via wind data analysis, performance checking and environmental impact calculations to grid connection calculation. With its integrated online data services, a user friendly interface and continuous development to integrate new research and knowledge, it is now the world leading software for wind energy project design. windPRO is used by project developers, independent experts, WTG manufacturers, grid operators, banks, authorities and others.

01 | Wind resource mapping in windPRO

02 | Photorealistic visualisation for PV plants and wind farms

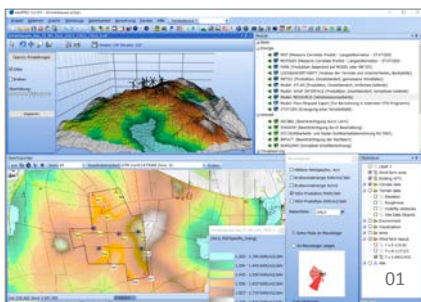

energyPRO – software for the simulation of distributed energy systems

energyPRO is the most advanced and flexible modelling software for combined techno-economic optimisation and analysis of a variety of heat, CHP, process and cooling related energy projects. In energyPRO you can model virtually any type of technologies from well-known, fossil fuel based production units to state-of-the-art renewables.



windOPS – web software for performance analysis of your wind farm

windOPS is a web-based wind power management and analytics software service developed for the daily performance monitoring and to compare, analyse and report operational and financial data for wind farm assets on a regular basis. Present and past operation data of WTGs from different manufacturers are shown in a unified view and summarized in a well-arranged portfolio view.



EMD Deutschland GbR

Adress	Breitscheidstrasse 6 34119 Kassel
Phone	+49 (0)561 31059-60
Fax	+49 (0)561 31059-69
E-Mail	sales-de@emd.dk
Web	www.emd.dk
Category	Other services
Profile	Software solutions
Turnover	> € 5 million (EMD Int. A/S)
Employees	10 (EMD Deutschland) (Wind energy: 6)
Founding year	1999



EnBW Energie Baden-Württemberg AG

A competent partner with know-how for third parties – at home and abroad

EnBW is active both on- and offshore along the entire value chain from development, acquisition, construction, operation, and direct marketing to wind turbine repowering. We rely on partnerships and also make our know-how available to third parties as a service provider.



01 | EnBW Langenburg wind farm with 12 turbines
 02 | The EnBW Hohe See and EnBW Albatross North Sea wind farms were connected to the grid in 2019/2020

We are one of the pioneers in offshore wind energy. EnBW Baltic 1 wind farm, Germany’s first commercial offshore wind farm in the Baltic Sea, was followed by EnBW Baltic 2, which means we have installed turbines with a combined rated output of 337 MW in the Baltic Sea.

are approaching the end of their service lives. Continued operations, repowering, or sale? As an experienced wind farm developer and operator, EnBW is available as a service provider with the long-standing know-how of an energy supplier to help with this major decision.

We are currently continuing our growth course in the North Sea and have connected a further 610 MW to the grid in 2019/2020 with the EnBW Hohe See and EnBW Albatross wind farms. Construction of our third North Sea project, EnBW He Dreiht, is scheduled to start in 2023. We are also dedicated to technology development: the Nezy2 research project, for example, involves floating wind turbine trials.

EnBW is continuing to grow both offshore and onshore. We focus on the core German market, but also on selected foreign markets. For example, we are active in the onshore segment through national affiliates based in France and Sweden. For instance, we have already developed a portfolio of around 100 MW rated output in Sweden through the purchase of project rights and existing project-ready parks. We are also represented via subsidiaries in the US-American and Taiwanese offshore markets.

EnBW has currently expanded its onshore portfolio throughout Germany to a rated output of over 500 MW. We intend to forge ahead with this expansion over the next few years to build up a portfolio of 2500 MW of rated output by 2025. We are also targeting existing wind farms that



EnBW Energie Baden-Württemberg AG

Address	Schelmenwasenstraße 15 70567 Stuttgart
Phone	+49 (0)711 289 0
E-Mail	windkraft@enbw.com
Web	www.enbw.com/windkraft
Category	Energy services
Profile	Construction, operation, direct marketing
Turnover	approx. € 18.7 billion (12.2019)
Employees	23,293 (12.2019)
Founding year	1997

energy consult GmbH

Your future-oriented partner for wind energy

Energy consult has over 25 years of experience in the commercial and technical operation of wind farms. We now manage 140 wind farms and more than 750 wind turbine generators in Germany with a total installed capacity of 1.7 gigawatts.

Energy consult currently unites three companies that provide competent, reliable services for wind farm operators and investors:

Wind farm management

As a specialist in the technical and commercial management of wind farms, energy consult GmbH (wind farm management) takes control of the success of your wind power installations. We offer you a full-service concept, assume overall responsibility for your wind turbine generators and take the strain off you as the operator. We carry out ongoing potential analyses to make your wind farm more profitable, identify potential for optimisation and ensure that measures are implemented correctly.

Inspection company

Energy consult Prüfgesellschaft GmbH specialises in all technical tests, inspections, legally prescribed safety checks and grid

protection tests for wind turbine generators. Our experts can detect possible damage at an early stage, prevent downtimes and increase system availability. This reduces the risk of exorbitant repair costs, loss of earnings and safety-related complaints.

MEB Safety Services

MEB Safety Services GmbH is not only specialist in the extensive safety technology required for your wind power installations but also expert in rope access technology. MEB tests and services fall protection PPE, hoists, cranes, service lifts and platform access systems. We carry out installation, maintenance and servicing work for fire extinguishers, fire alarm systems and obstruction lighting systems and advise you on questions concerning "on-demand night-time marking" (BNK). We also provide safety training on our own or the client's premises.

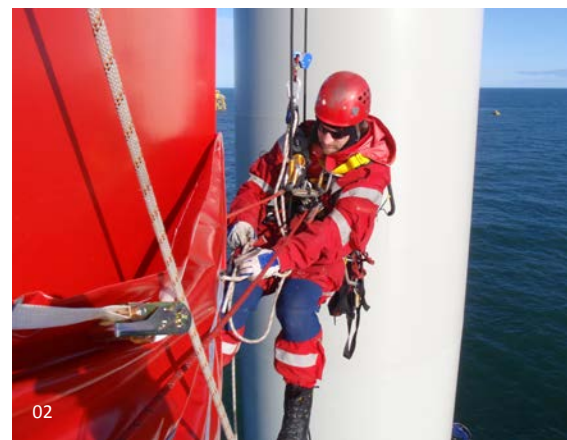

01 | Altenbruch wind farm, Niedersachsen

02 | Working at heights by MEB Safety Services GmbH



01



ENERGY CONSULT

energy consult GmbH

Address	Peter-Henlein-Straße 2–4 27472 Cuxhaven
Phone	+49 (0)4721 718 08
Fax	+49 (0)4721 718 399
E-Mail	info@energy-consult.net
Web	www.energy-consult.net
Category	Operation & Service
Profile	Technical & commercial operational management
Employees	80
Founding year	1991

Energiequelle GmbH

Energy transition? It's our business!

Energiequelle GmbH has been active in the renewable energies market since 1997. With more than 260 staff and over 750 installed wind turbines, we are one of the industry's leading companies – passionate, bold, and innovative.



In terms of funding and sales, we maintain long-term, collaborative relationships with plant manufacturers, credit institutions and investors, the result of which are innovative and bespoke funding solutions for our national and international customers.

Collaboration and project purchasing

We are always on the lookout for collaboration partners with whom we can pool our skills and advance projects together. Our services also include project purchasing – we take on projects at every stage, in Germany and abroad.

New business area for innovative energy concepts

Our business development colleagues are currently working on innovative future technologies, such as self-supply electricity solutions for industrial and commercial customers in the electricity, heating, and mobility sectors. We are also conducting research into Power-to-X projects and are currently developing a power generation reference constant for the generation, use and storage of hydrogen in the Lausitz region.



An experienced full-service provider

We have been implementing renewable energy projects for more than 20 years, developing, constructing and operating wind energy and photovoltaic plants, transformer stations and energy storage systems. We are also working on innovative energy supply solutions, managing repowering projects for old plants and selling sustainably produced electricity to end customers via our subsidiary eqSTROM.

We manage the electrical, technical, and commercial aspects of over 730 power production facilities. Our customers attest to our excellent customer service performance and praise our high level of customer friendliness, accessibility, and continuing reliability.



- 01 | Offices
- 02 | Michael Raschemann, founder and owner
- 03 | Schönefeld wind farm
- 04 | Schönefeld wind farm
- 05 | Energiequelle not only plans wind and PV systems
- 06 | Planned by Energiequelle: Feldheim, the first energy self-sufficient village in Germany



Internationally active

Our headquarters are in Kallinchen near Berlin and we also operate out of a total of 15 locations in Germany, France and Finland. The first project in Finland was launched this year; another one is under construction and an additional 800 MW are in the pipeline. We have already built over 100 wind turbines in France and are very well networked in the French market through our subsidiary P&T Technologie. We wish to gain a foothold in two further markets by 2025 and are, therefore, steadily driving forward our corporate growth.

05

References

In addition to Feldheim, the first energy self-sufficient village in Germany, we built a 10 MW energy storage facility in collaboration with Enercon and played a major role in the implementation of the “Green EuroSpeedway Lausitz”. We have now connected a total of over 750 wind turbines with a rated output of over 1,400 MW to the grid.



06

Personal, fair, and down-to-earth

Our company philosophy has not changed since 1997: in spite of the enormous growth we have experienced, we are still a family-run business and cultivate personal relationships, both in-house and with our partners. It is important to us to work on an equal footing in a mutually honest and fair manner and to be reliable at all times. This is what connects us in our common mission.

Business areas

- Wind power
- Photovoltaics
- Biogas
- Grid connection
- Energy storage
- Electricity sales and distribution
- Innovations

Services

- Project development
- Management
- Financing & sales
- Repowering
- Project purchasing & collaborations



04



Energiequelle GmbH

Adress	Hauptstraße 44 15806 Zossen OT Kallinchen
Phone	+49 (0)33769 871 100
Fax	+49 (0)33739 871 105
E-Mail	info@energiequelle.de
Web	www.energiequelle.de
Category	Planning
Profile	Planers & project developers
Turnover	approx. € 100 million
Employees	260
Founding year	1997

ENGIE Deutschland

Zero Carbon Transition as a Service

The energy market is fast moving. With ENGIE you have a competent and solid partner at your side. Take advantage of our broad experience for your projects, the operation and marketing of your plants or to optimise your wind farm in terms of revenue.

ENGIE's purpose is to act to accelerate the transition towards a carbon-neutral economy, through reduced energy consumption and more environmentally-friendly solutions. To this end, we develop efficient customer solutions for companies and local authorities. And this is what our diverse renewable generation activities are geared towards.

With an installed renewable energy capacity of 27.5 GW and an annual commissioning of 3 GW from 2019–2021, ENGIE is one of the leading and most active companies in the industry in Europe. With green Power Purchase Agreements we help our customers on the way to climate neutrality.

Working with an experienced partner pays off

For project development, we combine our experience from our long-standing partnerships with local utilities in Berlin, Gera, Saarbrücken and Wuppertal with the comprehensive technical expertise of a leader in renewable energies. We are not only interested in developing a wind farm, but we also think about its later operation from the very beginning. This serious and forward-looking planning pays off in the long run.

As operators of almost 300 MW wind turbines in five federal states, we know all the levers to optimise commercial and technical management.

In the background we have the experience of the ENGIE group with its 2,500 wind turbines at different locations and from different manufacturers. The group's test and material laboratory and technical experts provide all the necessary information for the best possible operation.

The ENGIE Renewable Energy Control Centre ensures the remote control and safety of 100 wind farms and 17 solar energy plants with a total of 825 wind turbines and 105,000 solar collectors in France, Belgium, Italy, Germany, Poland, Romania and the Netherlands. The digital platform "Darwin" is used to manage all data of our renewable energy plants.

As one of the largest players in the electricity market, ENGIE Energy Management manages a direct marketing portfolio of 3,500 MW, including onshore and offshore wind farms and solar parks. Our central trading platform in Brussels is manned around the clock and has access to all European electricity markets, from forwards to the intraday market.



01 | ENGIE-Control Center

02 | ENGIE is your reliable partner for wind onshore, whether for planning, construction, approval, operation, marketing, 24/7 trade or repowering.

01

New perspectives for wind farms after the expiry of the fixed feed-in tariff

We are there for you when it comes to finding the best solution for your wind farm after the EEG subsidy expires.

If you want to continue operating your wind farm yourself and generate calculable income, a long-term supply contract (PPA) with ENGIE is the right option. This also applies to owners of new plants who prefer marketing outside the scope of EEG support. Our offer includes fixed prices as well as indexed prices and floor structures, depending on your risk profile. The term is usually 1–10 years.

If you do not want to bear the risk and complexity of continuing operation, but would like to realise the profit now, we will buy your old plants and continue to operate them.



02

Do you have any questions?

Feel free to contact us:

Dr. Turang Ahadi-Oskui

Bereichsleiter Betrieb
erneuerbare Energien
ENGIE Deutschland GmbH
T +49 30 915810220
wind@engie.com

Katrin Fuhrmann

Global Markets
ENGIE Energy Management
T +49 221 46905-551
katrin.fuhrmann@engie.com

ENGIE Group in figures

- 5,000 employees in the renewable energy sector
- Over 800 locations with renewable energies worldwide
- 27.5 GW renewable capacity, thereof 8.5 GW onshore wind
- 3 GW of additional installed renewable capacity in 2019
- 8 GW in direct marketing in Europe
- Nr 1 in green PPA volumes sold in the world in 2019
- Represented on all major European trading platforms
- Best credit rating



ENGIE Deutschland

Adress	Tempelhofer Weg 10829 Berlin
Phone	+49 (0)30915810 250
Fax	+49 (0)30 915810 001
E-Mail	alexa.schroeder@engie.com
Web	www.engie-deutschland.de
Category	Energy services
Profile	Construction, operation, direct marketing

EWE ERNEUERBARE ENERGIEN GmbH

The wind is our element

Generating, storing and connecting green energy to the grid across sectors: as the pacemaker of northern Germany’s energy future, EWE has been driving the expansion of renewable energies for over 30 years and is a reliable partner for project planning, development, construction and operating concepts.

EWE – Your partner for the future

We have used the power of the elements to generate electricity since 1989. Whilst others only talk about sector coupling, we are implementing it: EWE operates throughout the entire value chain and is investing in a holistic energy future. Our Project Planning, Repowering and Operation, Direct Marketing, Storage, Electromobility, Green Hydrogen and Digital Networks business units are the building blocks for this.

Based in Oldenburg in Lower Saxony, EWE ERNEUERBARE ENERGIEN GmbH, is EWE’s competence centre for renewable energy production. Our focus within the wind energy sector is on project development, repowering and operating concepts. Our generation portfolio within the sector currently comprises about 370 megawatts, in addition to a comprehensive project pipeline in Germany and neighbouring countries. Apart from wind energy, EWE is also a strong partner for photovoltaics and biomass projects.

Teams from our subsidiary EWE ERNEUERBARE regional are currently expanding our expertise in the field of renewable energies a regional basis at our Hanover and Husum sites. In June 2020, TurboWind Energie and Gewi Planung und Vertrieb were merged to form EWE ERNEUERBARE regional GmbH.

We employ a total of 100 experts who are committed to a sustainable and economically viable energy future. And as this also requires public acceptance, we at EWE rely on public dialogue in all our projects to win the support of citizens, municipal decision-makers and the approval authorities on the basis of tailor-made wind farm projects.

With EWE ERNEUERBARE ENERGIEN at your side you will be fully prepared to face all the challenges of the new world of energy generation. And, last but not least, you can count on us to be a reliable investor or investment partner.



01

- 01 | In operation since autumn 2020: EWE’s Uetze-Süd wind farm, implemented by EWE ERNEUERBARE regional
- 02 | The EWE team at Hatten wind farm
- 03 | For EWE cooperation means open dialog

Our services

- Site planning and management from securing construction sites to grid connection
- Approvals and tendering
- Compensatory measures
- Plant purchase and construction supervision
- Participation and funding concepts
- Technical and commercial management
- The 20+ continuing operations concept
- Repowering
- Purchasing wind farms of all age classes
- Partnering models and collaboration

Shaping the energy transition as a partner

The wind industry is currently experiencing stormy times involving increasing competition, severe cost pressures and increasingly complex approval procedures in addition to complex nature conservation and environmental protection requirements. And, of course, to gain acceptance for wind projects, wind farm neighbours need to be considered. As a partner within this market environment, EWE ERNEUERBARE ENERGIEN shoulders investments and risks and can contribute a wealth of experience as well as a strong credit rating as a major energy service provider.



For wind energy companies who wish to devote themselves to other projects, we also offer the option of taking over existing plans, rights or wind farms.

Economic operations – including post EEG

Starting in 2021, many wind turbines will no longer be eligible for the EEG subsidy. EWE ERNEUERBARE ENERGIEN is prepared to meet this challenge: our customised operational and technical optimisation concepts ensure high yields, low costs, and the best possible security. EWE TRADING, our sister company, is a competent partner for energy trading on the electricity exchange.

Our wind strengths – your profit

EWE ERNEUERBARE ENERGIEN offers many opportunities for mutually beneficial collaborations including land acquisition, tendering procedures and project partnerships, economic operating concepts for older wind farms and optimised repowering strategies. If you need a successful trust-based partnership, we are here for you and offer our full commitment.



EWE

EWE ERNEUERBARE ENERGIEN GmbH

Adress	Donnerschweer Straße 22–26 26123 Oldenburg
Phone	+49 (0)441 48067-101
Fax	+49 (0)441 48067-195
E-Mail	erneuerbare@ewe.de
Web	www.ewe-erneuerbare.de
Category	Planning
Profile	Planers & project developers
Turnover	€ 75.8 million (2019)
Employees	100
Founding year	2013

envia THERM GmbH

As an energy producer, envia THERM sets the course for the energy future in eastern Germany to green. As a reliable and service-strong partner for wind energy projects, the company covers all services from project development to construction, repowering and operational management.



envia THERMs aim is to actively shape the energy transition in eastern Germany by expanding and developing renewable energies. As a competence center for regenerative energies, the energy service provider has a wide range of technologies as well as extensive expertise along all project development stages, from site analysis to the construction and repowering of wind turbines. The same applies to operations – from contract management and direct marketing to commercial and technical operations management and repowering of wind turbines.

envia THERM is a wholly owned subsidiary of envia Mitteldeutsche Energie AG (enviaM), currently the leading regional energy provider in eastern Germany. The company has many years' experience in energy production and combines all the generation activities of the enviaM Group. The portfolio includes bioenergy, photovoltaics, hydropower and wind energy at around 90 locations.

In addition to in-house development of wind farms and implementation of cooperation projects, envia THERM is also interested in acquiring project rights and purchasing equipment. The company is particularly keen on establishing confidence with local players and developing a sustainable collaboration with their full involvement. This includes individual participation concepts for citizens, local authorities and utilities.

envia THERM is a reliable and service-oriented partner for plant operators, project developers, local authorities and utilities with the necessary experience and competence to implement energy transition projects reliably and in full partnership with its clients.



envia THERM GmbH

Address	Niels-Bohr-Straße 2 06749 Bitterfeld-Wolfen
Phone	+49 (0)3493 5167-0
Fax	+49 (0)3493 5167-4402
E-Mail	info@envia-therm.de
Web	www.envia-therm.de
Category	Planning
Profile	Planers & project developers
Turnover	€ 127 million (2018)
Employees	161 (2018)
Founding year	2006

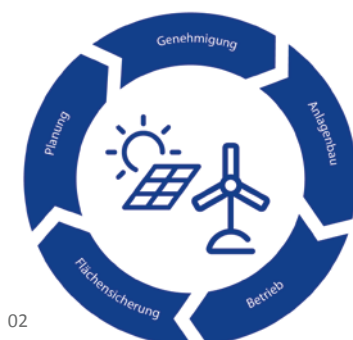

02

01 | Wind park in Großkorbetha
02 | Creation of value

Framatome

Outstanding service through innovative and individual solution approaches.

Framatome stands for CO₂-free energy production and has been supporting wind energy for years with expert knowledge, accredited capable laboratories, NDT procedures, diagnostic systems and quality assurance. Competence from 60 years in power plants is the basis for innovative solutions.

Quality and Root Cause Analyses of functionally relevant components are essential for reliable operation. A wide range of technical assessments are also necessary to evaluate a possible extended operation. Framatome develops interdisciplinary solution approaches and remedial measures. In doing so, we draw on various engineering and technical fields and accompany the implementation.

Specially developed products

- Monitoring & diagnostic (M&D) technologies for vibrations on structural components and rotating machines
- Phased Array NDT technology
- Flat UT probes for testing main rotor bearings without disassembly

Service for running plants

- Online data collection for predictive maintenance (from M&D)
- UT and ET NDT (incl. on bearings and bolt shanks)
- VT NDT with remote-controlled vehicles and portable submarines
- Material analyses for inspection support
- Root Cause Analyses, fast response times through 24/7 "Fitness-for-Service" assessments of mechanical components

Service for manufacturers

- Automated UT and ET NDT as production support for critical components and new materials (including rotor blades made of CFRP)
- Root Cause Analyses
- "Fitness-for-Service" assessments

Services for extended operation

- M&D data to determine real loads
- Determination of component condition through the use of NDT and material analyses
- Complex finite element calculations
- "Fitness-for-Service" assessments

Experienced material, testing and calculation experts contribute their many years of experience in power plant construction and service. We operate our own technologically well-equipped and accredited laboratories and use modern mobile testing equipment. In many areas, the technologies we use come from our own special development.

Your performance is our everyday commitment!



- 01 | Customizable software for realtime calculation of fatigue usage factor and remaining lifetime using online data from sensors mounted on wind tower structure.
- 02 | Phased Array UT of rotor bearings in assembled state with specially designed low-profile UT probe.
- 03 | Own high-quality equipped laboratories are used for material analyses, here shown a FIB (Focused Ion Beam) electron microscope.

framato**me**

Framatome GmbH

Adress	Paul-Gossen-Str. 100 91052 Erlangen
Phone	+49 (0)9131 900-31548
Fax	+49 (0)9131 900-94242
E-Mail	wind@framatome.com
Web	www.framatome.com/solutions-portfolio/pages/offer.aspx?bid=5
Category	Operation & Service
Profile	Service, maintenance & repair
Turnover	€ 3.3 billion (Framatome worldwide)
Employees	14,000 (Framatome worldwide)
Founding year	1958



GAIA mbH

Everything from a single source – that’s our claim

For more than 20 years, customers and partners appreciate our competence and reliability in planning, development, project coordination, service and operational management of wind turbines and photovoltaic systems.



- 01 | Wind turbine in Tiefenthal: GAIA Technical management.
- 02 | Kahlberg wind farm in Fürth/Grasellenbach: GAIA project development as a service provider for third parties.
- 03 | Everything from a single source: Enercon wind turbine in Mainz-Hechtsheim. 229.5 meters high. Commissioning: November 2019

We, the Gesellschaft für Alternative Ingenieurtechnische Anwendungen, short GAIA, are pioneer of renewable energy in Rhineland-Palatinate. Our core competences are planning and construction of wind energy and solar power systems as well as the development of individual sustainable energy concepts.

After the successful completion of a project, we take over the operational management for wind turbines, wind farms and photovoltaic systems and offer service and maintenance. Storage solutions, charging systems for E-mobility and drone-based services such as inspections, monitoring, aerial photography, mapping, documentation and 3D visualisations of your projects complete our portfolio.

Established in 1999 by Dipl.-Kfm. Torsten Szielasko and Dipl.-Ing. Michael Wahl as an engineering company, GAIA currently employs more than 50 highly dedicated and qualified members of staff, whose daily work contributes to sustainable energy generation and thus to environmental protection.

Holistic, sustainable, flexible

Everything from a single source – The keystone of GAIA’s business philosophy. Our customers appreciate us because we combine all the processes required for wind energy and solar projects: From initiation to the turnkey handover to the operator, we take care of all aspects of project management.

Many customers also use our broad spectrum of our individual services: Our GIS-based analyses helps you to find and evaluate the potentials of the project, to identify project risks early on and to optimize the site configuration. The project- and evaluation team will accompany you at every stage of development, identify project risks at an early stage and ensure the success of your projects or project acquisitions. We accompany and control your project during the construction phase. Always with the aim of reducing construction costs and minimizing risks, we will find innovative solutions to the challenges of your project.



GAIA mbH

Adress	Jahnstr. 28 67245 Lamsheim
Phone	+49 (0)6233 35944-00
Fax	+49 (0)6233 35944-01
E-Mail	info@gaia-mbh.de
Web	www.gaia-mbh.de
Category	Planning
Profile	Planers & project developers
Employees	52
Founding year	1999



GP JOULE GmbH

We develop values: From green field to electricity and hydrogen station

GP JOULE is your reliable partner for integrated management and development of energy projects, for successful implementation of projects based on our expertise, experience and reliability at every phase – from securing the location to continued operation, including post-EEG.

Since we were established in 2009, we have installed over 750 megawatts of renewable power plant capacity in Germany and abroad and now ensure the smooth operation of 750 megawatts in technical and 400 megawatts in commercial operations.

GP JOULE also stands for expertise across the entire value chain of renewable energies and offers a full range of services from project development to wind power upgrading through Power-to-X in hydrogen, heat and mobility.

Landowners and municipalities benefit in a special way from our broad range of services. We carry out projects together and our background in agriculture means that our approach to the land as a precious resource is particularly respectful.

Wind farm operators optimise and secure their returns through our experienced technical and commercial management with a modular range of services and ISO-certified quality. Operators of old plants will continue operating with us – in addition to the repowering option, GP JOULE has extensive project experience in post-EEG operation through its expertise in electricity conversion to hydrogen and in electricity marketing.

Investors benefit from our know-how as project planners and operators, our direct and exclusive access to the market and from intelligent usage models with added value. We offer you sustainable investment strategies for value creators.



Unsere Investition in Qualität:
GP JOULE SERVICE ist gemäß ISO 9001 zertifiziert.

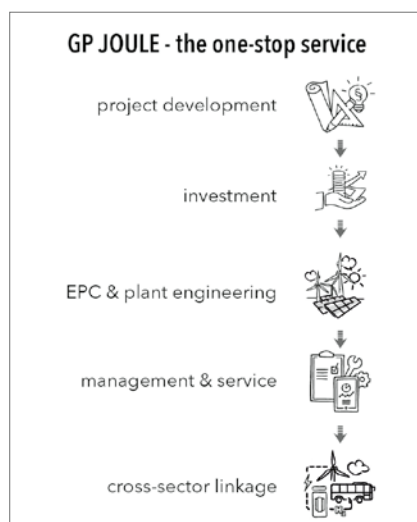

GP JOULE
TRUST YOUR ENERGY.

GP JOULE GmbH

Adress	Cecilienkoog 16 25821 Reußenköge
Phone	+49 (0)4671 6074-0
Fax	+49 (0)4671 6074-119
E-Mail	info@gp-joule.de
Web	www.gp-joule.de
Category	Planning
Profile	Planers & project developers
Employees	290
Founding year	2009

Green Wind Group

With the power of wind: on- and offshore project development & operational management
Green Wind is a group of independent wind energy companies headquartered in Berlin-Mitte, with offices in Denmark and projects in Germany and Scandinavia. Green Wind operates independently for the international market.

The Green Wind Group operates as an umbrella company based on three stable pillars: wind energy project development, technical and commercial management for onshore wind turbines and substations as well as maintenance management and monitoring of technical facilities for offshore power generation. All this is flanked by the aid of greenwind control, a standalone, state-of-the-art control room that operates on a 24/7 basis.

Green Wind was founded ten years ago by Martin Kühl and Manuel Lasse, a wind-power pioneer and a technology specialist. Driven by the power of wind, Green Wind has successfully established itself as an independent company within the market. The company's continuous growth is enabled by its 50 or so employees, who use their wind expertise to turn exciting ideas into reality, whether on- or offshore in Germany, Denmark, and Sweden. Repowering is one of the company's key policies.

Repowering increases efficiency

Repowering – in other words, replacing an older and smaller turbine with a new one – is now a worthwhile strategy for many wind farms that were built more than ten years ago, as it can extend the service life of an existing power station and increase its efficiency by three to five times. Moreover, EU subsidies for many turbines over 20 years old will expire as of the end of 2020. A wave of dismantling, efficient continued operations and repowering is heading towards Germany, which must be exploited effectively to achieve government climate targets. Green Wind meets this challenge with the aid of data-based calculation tools for potential continuing operations, repowering checks as well as experienced and proven project development experience.



01 | Wind farm repowering project Vormark/Prignitz, Brandenburg: After dismantling the old turbines 14 new turbines were erected (nominal output of 48.3 MW).



Repowering – yes or no?

What are the benefits of repowering for the operator? In the best-case scenario, fewer turbines and an increased rated output, better integration with the power grid, and lower maintenance costs. Should the operator conclude, on the basis of all available data and facts, that repowering is an economically viable option, Green Wind will help with the implementation, from the preliminary research and approval procedures through to implementation and operation, as well as the technical and commercial management.

Energy yield doubled

Green Wind can point to a number of relevant reference projects which have been successfully planned and implemented in the interest of the operator, the largest of which is the Vormark/Prignitz wind farm (Groß Pankow), where Green Wind dismantled 14 existing old turbines and constructed 14 new ones at the same site, as well as a separate transformer station.



The new facilities were erected within three months and the original 21 megawatts of rated output were upped to 48.3 megawatts, which means that the energy yield was more than doubled as a result of repowering.

Market growth in Denmark

Due to the market growth in Denmark, Green Wind project development has been required to prepare and implement repowering projects at approximately 30 sites in Germany since 2019 (mostly in suitable or priority areas), in which Danish operators in particular hold shares. More projects are currently being planned or are going through the approval process at various locations in Brandenburg and Lower Saxony.

- 02 | Wind farm repowering project, Timberg/ Zehdenick, Brandenburg: Dismantling old turbines and erecting two new turbines.
- 03 | Vormark/Prignitz wind farm: Dismantling 14 old wind turbines.
- 04 | Rottelsdorf wind farm/Saxony-Anhalt: Green Wind builds the Freist transformer station.

Hydrogen will also be included in the future

Green Wind is also working on an innovative concept for Pritzwalk/Giesendorf, which may involve the repowering of old hydrogen production plants that could be fed in and utilised in a decentralised manner.



Green Wind Group

Adress	Alt-Moabit 60a 10555 Berlin
Phone	+49 (0)30 3512 886 30
Fax	+49 (0)30 3512 886 33
E-Mail	info@greenwindgroup.de
Web	www.greenwindgroup.de
Category	Planning
Profile	Repowering
Employees	56
Founding year	2008

greenmatch AG

Web-based financial software & financing expertise for renewable energy

With green[::]match you can structure, manage and transact your investments in wind energy, photovoltaics, hydropower and biomass reliably and efficiently. Digitalise and optimise your transaction and asset management processes with our software and services.



01

- 01 | greenmatch Cashflow-Waterfall
- 02 | symbolic picture Onshore-Wind Farm
- 03 | greenmatch Year-to-date Performance Monitoring

Valuation: Efficient and reliable project evaluation

Valuation is a certified and web-based financial modeling software for renewable energies. Thanks to the **standardised financial model, unnecessary discussions about calculation methods are obsolete.** Even the most complex project structures can be **modeled, simulated and aggregated into a portfolio** in a short time. So far, more than **1,700 green[::]match projects** from around the globe have already been evaluated and shared via Valuation.

Asset Controlling: Monitor & optimise financial performance

With the help of the Asset Controlling tool, you can **keep a constant eye on your projects throughout their life cycle, optimise them** and thus **increase their returns.** The intuitive overview about all target and actual figures for your projects also provides you with a wide range of reporting options.

Marketplace: Buy and sell projects

Benefit now from the green[::]match network, off-market with individual match-making or via our public digital marketplace, through which **transactions worth 400 million EUR** have been processed to date.

Services: Consult expertise

With our **tailor-made consulting services**, you will be closely supported throughout the **entire project life cycle** and are at the **right address with us** for all questions concerning the financing of your projects.

Our team offers **highly specific expertise** and **many years of experience in project financing** and **optimisation** of renewable energies (at **project** and **portfolio level**).

Convince yourself!: www.greenmatch.ch

green[::]match

greenmatch AG

Adress	Greifengasse 1 CH-4058 Basel
Phone	+41 (0)61 301 50 00
E-Mail	info@greenmatch.ch
Web	www.greenmatch.ch
Category	Other services
Profile	Software solutions
Employees	11
Founding year	2013



02



03

Grzib Elektrotechnik GmbH & Co. KG

Service provider with more than 20 years of experience in the wind industry

We are not only available in Germany, but also in other European countries:

So far, we have successfully installed around 3,100 wind turbines all over Europe.

The requirements of planning and erecting a wind farm are diverse. Especially external partners need to be reliable, flexible and professional, demonstrating their work experience at its best in order to complete these projects successfully and failure-free. With us, our customers have found a qualified and flexible partner.

We know the challenges in project planning and are therefore able to offer customer-oriented services to avoid disturbances and difficulties.

Our range of services during new construction projects and repowering includes:

Work in the low-voltage range

- Visible installations such as inner and outer tower lighting
- Cabling of power cables (Connection converter to transformer)
- Implementing transformer and plant protection

Work in the medium-voltage range

- Connection of medium-voltage switchgear to transformer
- Commissioning of transformers and medium-voltage switchgears
- Switching operations in the medium-voltage range up to 36 kV
- Implementation of earthing and lightning protection concept

Work in the field of measurement and control technology

- Cabling of superior parking controllers and their signal exchange

Maintenance and service of transformer, medium-voltage switchgear and converter

Other services

- Installation of cable support systems in steel and hybrid towers
- Delivery of WTG-specific safety equipment
- Assembly of medium-voltage cable bridges according to customer requirements

For more information go to www.grzib-elektrotechnik.de



01 | Lothar Grzib (Founder & Managing Director)
02 | Andreas Grzib (Managing Director)

Grzib Elektrotechnik GmbH & Co. KG

Adress	Zur Kokerei 21 46117 Oberhausen
Phone	+49 (0)208 884 839 24
Fax	+49 (0)208 884 839 26
E-Mail	info@grzib-elektrotechnik.de
Web	www.grzib-elektrotechnik.de
Category	Operation & Service
Profile	Service, maintenance & repair
Turnover	€ 3.5 million
Employees	25
Founding year	1998

Hamburg Messe und Congress GmbH

the global on- & offshore event

With more than 1,400 exhibitors from roughly 40 countries, WindEnergy Hamburg is the foremost platform for the wind industry as it continues to develop wind power around the world.

Since 2014 the world's leading wind industry expo has been providing a common platform to all key players of the industry, including specialised suppliers and start-ups from all sections of the value chain for the onshore and offshore segments. The programme features product launches by major wind turbine manufacturers and component suppliers, and showcases services custom-tailored to address the challenges of the global wind industry.

One of the key purposes of this trade fair is to provide international companies, industry associations, and political decision-makers with a direct networking opportunity. Furthermore, the programme highlights strategies for project implementation in highly heterogeneous markets. Through its innovative featured topics, WindEnergy Hamburg looks ahead to the future of wind energy production, integration and storage.



- 01 | WindEnergy Hamburg 2020 postponed to December, 1 – 4.
- 02 | International companies presenting their innovations and services for the onshore and offshore wind industry
- 03 | WindEnergy Hamburg's press conference
- 04 | 1.400 exhibitors and 35.000 visitors attend the WindEnergy Hamburg on a regular basis.
- 05 | Hermann Albers (President German Wind Energy Association), Bernd Aufderheide (President and CEO Hamburg Messe und Congress GmbH) and Ivor Catto (Chairman WindEurope) in 2016 at the opening of the WindEnergy Hamburg
- 06 | Federal Minister for Economic Affairs and Energy Sigmar Gabriel and First Mayor of Hamburg Olaf Scholz at the press conference with Bernd Aufderheide (President and CEO Hamburg Messe und Congress)

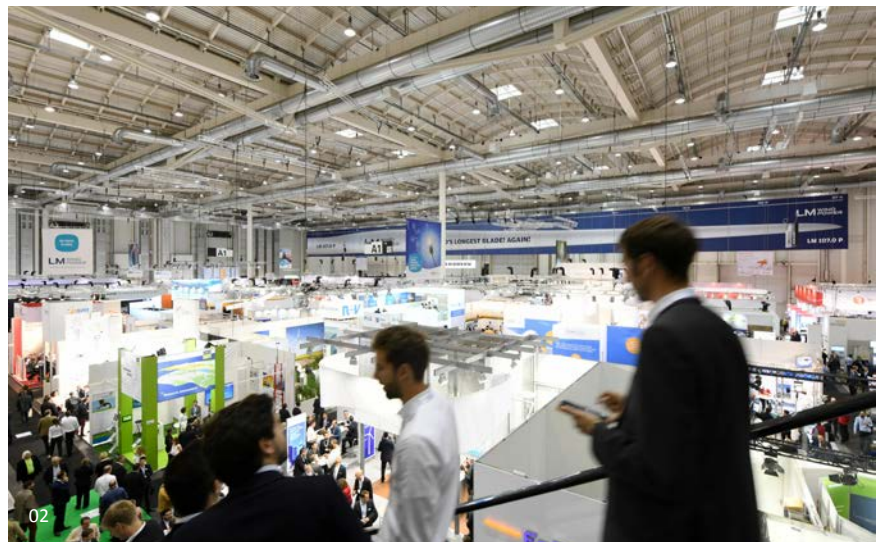



03

Solutions for sector coupling, i.e. the use of wind power for mobility, heating and industrial applications, are high on the agenda, as well. Covering all these specific areas, the world's leading wind industry expo is a major force driving the global energy transition towards a carbon-free energy supply for the world.

As an ideal match for the exhibition programme, the global conference organised by WindEurope, which runs in parallel, addresses all the current main topics of the industry. In addition, the new "Insights" stages prepared by WindEurope, titled "Power4Climate" and "Empowering People", are dedicated to topics of particular interest. The Global Wind Energy Council (GWEC), Global Partner of the event, will present "Global Business Insights". All this combines into a comprehensive agenda with added keynotes and panel discussions featuring international experts who, as thought leaders from the industry and science worlds, will be available to answer questions from all visitors, enriching the trade fair experience with their expert knowledge.

WindEnergy Hamburg was originally scheduled to take place from 22 to 25 September 2020. Because of the coronavirus pandemic and its consequences for major events and international travel, Hamburg Messe und Congress GmbH (HMC) postponed WindEnergy Hamburg to 1 – 4 December 2020. As always WindEnergy Hamburg will make sure all interested exhibitors and visitors can participate in 2020. In the year of the coronavirus pandemic, the world's leading wind industry expo will offer new added-value services and a new event experience through its digital platform.

Stay tuned, and be sure to take part!

The subsequent WindEnergy Hamburg trade fair will take place from 27 to 30 September 2022.

For up-to-date information go to windenergyhamburg.com



06



Hamburg Messe und Congress GmbH

Adress	Messeplatz 1 20357 Hamburg
Phone	+49 (0)40 3569-2263
Fax	+49 (0)40 3569-692263
E-Mail	andreas.arnheim@hamburg-messe.de
Web	www.windenergyhamburg.com/en
Category	Other services
Profile	Trade fairs & conferences for the wind energy industry
Employees	more than 300
Founding year	1972

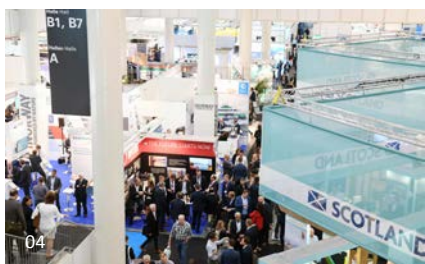

04



05

Helling GmbH

Innovative surface crack detection on wind turbines

In materials testing, the detection of the smallest material defects is crucial for the safe operation of wind turbines. As a leading company in the field of non-destructive testing, HELLING GmbH is continuously working on making surface crack detection more reliable and cost-effective.



As a long-standing partner of the wind industry, HELLING GmbH supplies high-quality systems, equipment, and consumables for non-destructive testing. In addition to the widely used HELLING magnetic particle suspensions, state-of-the-art UV-LED technology, and the well-known penetrant testing systems, HELLING has increasingly focused on the development of magnetisation equipment for crack detection on components for the wind industry.

Furthermore, UV LED technology for the inspection of large components, weld seams and gears of wind turbines is being continuously developed. Also, there are significant new developments in the field of non-hazardous and ecologically compatible testing media. For example, a new type of dry concentrate of magnetic particles has been developed for the preparation of water-based suspensions.

There are also significant innovations in the field of systems and equipment for crack detection: From ergonomic hand magnets to powerful high-current generators with pulse magnetisation, and PLC-controlled magnetic benches. The well-known Dykem® products supplied by HELLING are used with great success to monitor the properties of gear components in operation and to check the load-bearing capacity of gears.

The DGZfP Training Centre Hamburg/HELLING offers qualification courses in most NDT procedures such as VT, PT, MT, RT and UT according to DIN EN ISO 9712, as well as in the training of inspectors (PT, MT and UT) according to DIN 54161 and in radiation protection.

A well-equipped optical measuring laboratory, complex test series and certification according to DIN EN ISO 9001 make a decisive contribution to ensuring a high-quality standard and the further development of our products.



Helling GmbH

Address	Spökerdamm 2 25436 Heidgraben
Phone	+49 (0)4122 922 0
Fax	+49 (0)4122 922 201
E-Mail	info@helling.de
Web	www.helling.de
Category	Operation & Service
Profile	Service, maintenance & repair
Founding year	1863



- 01 | Fluorescent Magnetic Particle Inspection with Super Magna LY 2500 and UV-Inspector 711 IP 65 – UV-LED-Hand-held Lamp verified with Reference Block No. 1
- 02 | Contrast Penetrant Testing with TORNIA TRES-CHECK PREMIUM Typ 4103 Penetrant red-visible-TGL und Hell-Light VT13 verified with Reference Block No. 1 according to DIN ISO 3452-3

IDASWIND GmbH

WIND IS LIFE

For over 20 years we have been offering the entire spectrum for the development of WTG concepts in all performance classes. Our special competence in the field of load simulation and strength calculation also form the basis for our reports in the lifetime extension of WT 20+.

IDASWIND was founded in 1999 as an independent engineering office and is a reliable partner for national and international clients in the wind energy sector for more than 20 years.

We are an engineering office with innovative ideas and a persistent ambition to make an important impact for the development of the renewable energies.



Development

From the first concept to series production - IDASWIND offers the entire spectrum of know-how for the development of wind turbines and their individual components. Based on the latest technology standards and in close cooperation with our international clients, we take care of design and development, certification. Furthermore, planning of production facilities and conduction of trainings is also a part of our extensive portfolio.

Analytics

Wind energy is an important component in the context of climate change. In terms of sustainability and the exploitation of all potentials, we support operators with qualified reports for the lifetime extension of WTs after the exceedance of the planned design life. IDASWIND lifetime extension reports provide specific information on the prospects and conditions for a safe lifetime extension of each wind turbine.

- 01 | From WTG-design to LTE-reports
- 02 | Design & Development of Multi-Megawatt Turbines
- 03 | LTE- reports according to DIBt, DNV GL and BWE

IDASWIND

IDASWIND GmbH

Adress	Pintschstraße 3 10249 Berlin
Phone	+49 (0)303 642887 70
Fax	+49 (0)303 642887 77
E-Mail	info@idaswind.com
Web	www.idaswind.de
Category	Inspection bodies / measurement institutes
Profile	Technical consultants
Employees	12 (Wind energy: 12)
Founding year	1999

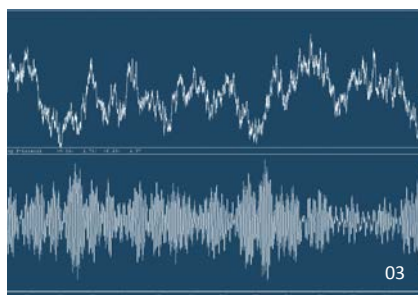
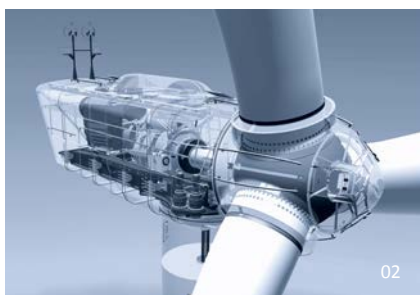

in.power GmbH

Direct marketer from the very beginning, experienced, inovative and independent

As a pioneer in direct marketing, the in.power group offers numerous services. Whether it is direct marketing, meter operation, continued operation or regional green electricity products for end users – we are your partner!



Based in Mainz, the **in.power group** has been active in the direct marketing of renewable and environmentally friendly energies since 2006 as one of the first companies in Germany. The company name is derived from “independent power” and is an expression of the explicit independence of the company. **in.power GmbH** has various subsidiaries that offer a wide range of services related to direct marketing.

in.power metering GmbH is an independent meter operator for renewables and for commercial users. Apart from online data logging and an in-house web portal that allows you to view all relevant data and the profit generated for each unit, the subsidiary also provides for remote control.

The subsidiary **grün.power** supplies green electricity regionally and nationally, based on simultaneous full supply from solar, wind, and hydropower. This form of distributing green electricity to end users also offers new opportunities for the continued operation of units after the 20-year compensation through the EEG.

in.power optimise GmbH offers innovative full services for optimising consumption forecasts (day ahead, intraday) for large commercial and industrial customers to minimise the risks and costs associated with balancing energy. It does so on the basis of calibrated online metering technology and intelligent consumption forecast models.

in.power balance GmbH will soon be responsible for the field of balancing energy derived from wind turbines and PV systems.

in.power network GmbH is a platform for joint ventures that offers a range of services and direct market access to market partners. It is also a highly specialised incubator for new, innovative subsidiaries. A first example is max.power GmbH, a joint venture of the construction company Max Bögl and in.power network GmbH.



in.power GmbH

Adress	An der Fahrt 5 55124 Mainz
Phone	+49 (0)6131 69657-0
Fax	+49 (0)6131 69657-29
E-Mail	kontakt@inpower.de
Web	www.inpower.de
Category	Direct marketing
Profile	Direct marketers
Employees	approx. 15
Founding year	2006

01 | Josef Werum (left) and Matthias Roth (right), Proprietors and Managing Directors of the in.power Group

02 | The in.power Team



KOOPMANN Group

Professional services for all aspects of power distribution

The KOOPMANN Group is one of Germany's leading energy and electrical engineering specialists. Our wind industry services: cable testing, power plant assembly, circuit breaker services, testing & diagnosis, transformer servicing, power centres, protection technology and operational management.

Our wind power sector services include comprehensive planning and project support, system assembly, maintenance, servicing, and repair as well as the supply of turnkey distribution and switching stations. We cover everything from the new installation of switching stations, cable lines and transformers up to 110 kV, to commissioning, repeat and protection testing to standards compliant grounding measurements and network analyses. We have invested in technical systems and personnel for our transformer service and have our own oil laboratory in which we carry out and evaluate all VDE oil analyses. Our mobile oil treatment plants enable us to carry out extensive on-site services on transformers of any size.

Our core competencies include cable testing and diagnosis.

Our equipment includes cable measurement and diagnostic vehicles, mobile systems including for pre- and post-location, PD measurement systems, HV testing systems up to 250 kV, the CPC 100 test system as well as devices for insulation, transformation ratio, winding resistance and dielectric frequency response measurements for transformer testing.

Our cable test van, known as "The Beast", is equipped with **the world's most powerful VLF testing facility** for cables up to 100 km in length and 60 kV and includes an impact device for MV and HV cables.



We also own a high-performance measurement system housed in an ocean going container which is used for the precise location of cable faults both on- and off-shore. We can also take on the operational management of energy and electro-technical infrastructure systems.

Our team is available 24/7, is professionally and technically equipped, and will ensure the safe and long-lasting operation of your energy supply facilities.



01 | Our specialists are available 24/7 and well equipped both in terms of expertise and technical apparatus

02 | 100 kV partial discharge measuring system



KOOPMANN Group

Adress	Zum Brook 19–21 49661 Cloppenburg
Phone	+49 (0)4471 9494-0
Fax	+49 (0)4471 84895
E-Mail	info@hk-c.de
Web	www.hk-c.de
Category	Operation & Service
Profile	Service, maintenance & repair
Employees	340
Founding year	1982

juwi AG

energy is here

Project development with competence, experience, and passion. juwi has been implementing renewable energy projects economically and reliably for 25 years. We lease areas, plan all necessary approvals, order the components, and build the wind farm. We also buy project rights.



Competent, experienced and in partnership

juwi is one of the leading specialists for wind and solar energy projects. In numerous projects we have proven ourselves as a cooperation partner for regional project developers, energy suppliers and energy cooperatives. Together with our parent company MVV Energie AG, we also have extensive expertise in direct marketing and electricity trading. Long-term collaborations with all important turbine and component suppliers guarantee our reliability.

Juwi was founded in 1996 in Rhineland-Palatinate. The juwi Group employs around 850 people worldwide and is present on all continents. More than 1,000 wind turbines and over 1,700 photovoltaic systems are proof of the company's 25 years of expertise in the field of renewable energies.

Complex locations & repowering

Across Germany, juwi has installed around 820 wind turbines with a capacity of more than 2,000 megawatts, in many cases with the participation of citizens and local authorities. Even in extraordinarily complex locations with hilly or forested terrain, juwi can demonstrate great expertise. juwi also has numerous references in the field of repowering.

Pioneering partnership

The juwi Group and MVV Energie AG have been working together since 2014 to create an efficient, secure, and climate-friendly energy system. Thanks to our partnership with one of the largest energy suppliers in Germany, we can cover the entire energy industry value chain. Together, we offer plant operators attractive solutions even after the end of subsidies ("post-EEG") - for example, with our MVV20plus product for continued operation after 20 years.



juwi AG

Address	Energie-Allee 1 55286 Wörrstadt
Phone	+49 (0)6732 9657-0
Fax	+49 (0)6732 9657-7001
E-Mail	info@juwi.com
Web	www.juwi.com
Category	Planning
Profile	Planers & project developers
Employees	approx. 850 (juwi Group)
Founding year	1996

01 | Experts for onshore wind energy: the juwi Group

02 | Wind power in harmony with nature



juwi Operations & Maintenance GmbH

energy is here

We provide the whole range of technical and commercial management services as well as wind and PV system maintenance. We have been optimising yields for our customers for around 25 years. We also have attractive offers for continued operations following 20 years of EEG subsidies.

Technical management

We provide support with legal, insurance and regulatory compliance requirements. Malfunctions are analysed and rectified immediately, and you receive comprehensive reports. You will also benefit from the personal support of a qualified technical customer advisor, who will assert your claims quickly and effectively. We fulfil all occupational health and safety requirements on your behalf using our AMS system (which is BG ETEM, OHSAS certified).

Maintenance

Build on our many years of experience in everything from recurring to condition-based inspections as well as maintenance and site care. We will take on the maintenance of all components according to manufacturer's specifications and will provide well-founded action recommendations. Fast and effective repairs complement our service offering to ensure maximum yields.



Commercial business management

We will manage your entire financial affairs, from commercial accounting and dunning to payment transaction processing. We can also manage your communications with your business partners. Build on our experience in budget and liquidity management: our services include shareholder meeting support, contract management and advice on legal and regulatory optimisation.

Remote monitoring from our control room

We guarantee the smooth flow of maintenance and repairs based on our professional 24/7 monitoring system, which enables us to optimise the technical availability of your systems and forms the basis for the best possible electricity yields.

Continued operation after 20 years

Together with our parent company, MVV Energie, we can offer you attractive conditions through our MVV20plus product.



juwi Operations & Maintenance GmbH

Address	Energie-Allee 1 55286 Wörrstadt
Phone	+49 (0)6732 9657 5090
Fax	+49 (0)6732 9657 7001
E-Mail	info@juwi-om.de
Web	www.juwi-om.de
Category	Operation & Service
Profile	Technical & commercial operational management
Employees	120 (only O&M)
Founding year	1996

01 | Control room at juwi's headquarters in Wörrstadt

02 | Continued operation or repowering? We take care of the right choice.

The Liebherr Group

A Strong Partner for the Wind Industry

For 70 years, the Liebherr name has stood for excellent, benefit-oriented products and services. The Liebherr Group is not only one of the world's leading manufacturers of construction machinery; it is also a major supplier in many other fields of engineering like the wind industry.



01

Liebherr is a powerful partner for the wind industry and offers convincing solutions for a wide range of requirements: On the one hand, components manufactured by Liebherr are installed directly into wind turbines. On the other hand, the company's mobile, crawler, offshore and tower cranes, for example, are used for erecting wind turbines and constructing wind farms.

Offering slewing bearings, slewing drives, electric machines, frequency converters and hydraulic cylinders, Liebherr is the only manufacturer worldwide that provides not only single components, but also entire systems for electromechanical and hydraulic pitch and yaw adjustment in wind turbines. For rotor blade adjustment, Liebherr offers moment bearings in two main designs: as double-row tapered roller bearings or triple-row roller bearing slewing rings. The portfolio also includes compact full scale converter solutions for wind turbines with a capacity from 2 to 5 MW.

- 01 | From single components to final assembly, Liebherr offers the matching solution for different demands of the wind industry.
- 02 | Liebherr LTM 1750-9.1 mobile crane installs the rotor star at a hub height of 80 m.
- 03 | Heavy duty CAL 64000-1500 Litronic® offshore crane during the installation of rotor stars in the North Sea.
- 04 | Liebherr tower cranes of the type 1000 EC-B are specially designed to erect wind turbines and work extremely precise with a space-saving design.

One of the major elements of cooperation with customers from all over the world is application-specific engineering to perfectly adapt each of the components. In the wind industry, Liebherr collaborates with nearly all leading turbine manufacturers and so far has equipped numerous wind turbines with its own components. The product portfolio comprises components for turbines from 800 kW up to solutions for multi-megawatt offshore turbines.

With their innovative technology, high quality, profitability and longevity, mobile and crawler cranes from Liebherr own a leading position in the world market. For decades, they have also been proving their value in the construction of wind farms. As well as telescopic mobile cranes, Liebherr also provides lattice



02

boom mobile cranes and crawler cranes to erect wind power systems, in a variety of performance classes, specifically matched to meet the needs of the wind power industry. The Group keeps pace with the development of larger and more efficient turbines as well as the increasing hub heights by offering cranes with optimized performance and new jib systems, reaching higher lifting capacities.

Cranes on narrow crawler travel gears especially developed for the construction of wind farms can move on the narrow tracks from one unit to the next in full setup condition, that is including jib and full ballast. This is especially economical, because machine and equipment have to be mounted only once.



For erecting wind turbines with a hub height of 110 m or more in low-wind areas, Liebherr also offers specially developed tower cranes with lifting capacities of up to 125 t. They are mounted on the wind turbine and are configured in a way that the necessary lifting height can be reached by guying the crane to the mast at one point only. Advantages are reduced space required by the crane, the ability to work despite high wind speeds and sensitive lifting of loads using Micromove.

Liebherr also offers efficient solutions for the erection of offshore wind turbines. Heavy duty cranes for offshore applications are able to lift up to 5,000 t and reach a lifting height of 180 m above deck. Thereby the Group's offshore portfolio meets challenging requirements, such as the provision of diesel or electrical drive units, explosion protected cranes and cranes for ambient temperatures between +40 °C and -50 °C.

Liebherr cranes are not only used successfully for the construction of offshore wind turbines, but also on oil and gas platforms, for offshore construction, pipe-laying or subsea operations down to 3,600 m below sea level.

LIEBHERR

The Liebherr Group

Address	Hans-Liebherr-Strasse 45 88400 Biberach an der Riss
Phone	+49 (0)7351 41-0
Fax	+49 (0)7351 41-265
E-Mail	info.lho@liebherr.com
Web	www.liebherr.com
Category	Transport & Logistics
Profile	Crane companies, crane hire & special transport
Turnover	€ 11,750 million (2019)
Employees	48,049 (2019)
Founding year	1949

M.O.S.S. Computer Grafik Systeme GmbH

Domain-specific planning application and GIS based optimization of wind farm planning
 M.O.S.S. offers planning application services, as well as integration solutions and consulting services with respect to optimizing the processes of planning wind farms (WPPA)

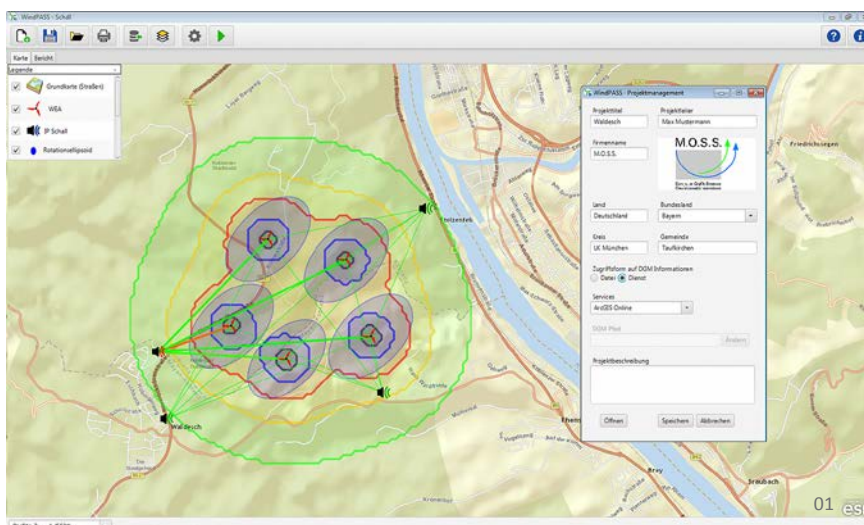

Wind farm planning & IT infrastructure (Wind-PIA)

Wind farm planning processes do not run chronologically, but iteratively. Supposedly reliable results can change again and again during the planning process. For project developers it is therefore all the more important to work with a structured, standardized and coordinated planning process. Wind-PIA can make wind farm planning more efficient by means of standardized geodata and information exchange. Technical, structural and organizational obstacles in the planning process are identified and reduced; e.g. by reducing duplication, avoiding data conversions and projection changes, or local and redundant data storage. Working with Wind-PIA can make wind farm planning processes up to 20 % more efficient.

WebService for buffering official building footprints for restriction area analysis

M.O.S.S. has acquired the full ALKIS database of building footprints including their attributes for all of Germany and prepared them as a password-protected web service.

On this basis, wind farm planners are able to buffer settlement areas in the area under consideration in a differentiated manner. In doing so, wind farm planners can be guided by the specifications of the respective planning authorities and buffer each building type in a differentiated way, depending on whether it is located in an inner (agglomeration) or outer zone (rural region). Buffer results are made available for download as shapefiles, so that they can easily be merged with other basic data in a local GIS.

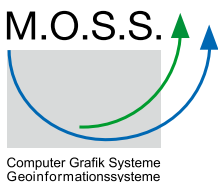

M.O.S.S. Computer Grafik Systeme GmbH

Address	Hohenbrunner Weg 13 82024 Taufkirchen
Phone	+49 (0)89 66675-100
Fax	+49 (0)89 66675-180
E-Mail	info@moss.de
Web	www.moss.de
Category	Other services
Profile	Software solutions
Employees	65
Founding year	1987

Messe Husum & Congress GmbH & Co. KG

HUSUM Wind – We take wind a step further

From 14–17 September 2021, Germany's mecca for wind will revolve around wind energy and transformative future technologies such as green hydrogen and storage.

www.husumwind.com

Every two years at the HUSUM Wind, 550 exhibitors present product innovations, cutting-edge technology and innovative wind energy solutions for the renewable energy systems of tomorrow. OEMs and market leaders for onshore, offshore, service and financing are a fixed component of the legendary industry meeting. HUSUM Wind has supported the wind industry through its changes for more than thirty years, providing practical relevance, product innovations and networking opportunities.

Brandenburg is the official partner state of HUSUM Wind 2021. With its expansion target of 10,500 MW for onshore wind power by 2030, extensive technology promotion and successful production site placement in the field of e-mobility, Brandenburg has owned international reputation and is a star amongst the German states at the forefront of the energy transition. Brandenburg has strong momentum for the expansion of renewables and, with its Wind Turbine Tax Act, Brandenburg is the first federal state to provide financial incentives in order to increase acceptance – an issue of nationwide relevance in terms of expanding wind power.



The offshore industry is well represented with the WAB e. V. The industry network and HUSUM Wind have once again joined forces. WAB e. V. is the first port of call anywhere in Germany for the offshore wind industry and the onshore network in the country's north-west.

The realisation of the exhibition under potential pandemic conditions is ensured through various strategies and concepts. Special forums, trade conferences, networking events and the Windcareer job fair round off what's on offer for the approximately 18,000 industry visitors.

HUSUM Wind – 14 to 17 September 2021
www.husumwind.com



Messe Husum & Congress GmbH & Co. KG

Address	Am Messeplatz 12–18 25813 Husum
Phone	+49 (0)4841 902-0
Fax	+49 (0)4841 902-246
E-Mail	info@husumwind.com
Web	www.husumwind.com
Category	Other services
Profile	Trade fairs & conferences for the wind energy industry
Employees	40 (Wind energy: 10)
Founding year	1989

MLK-Gruppe

Success for many – in a sustainable way

Since its establishment, the MLK group has implemented numerous wind farms. Experience, success, sustainability: not only the energy transition is driven forward. Citizen participation, fairness towards our business partners and active support of our staff are an integral part of the group’s DNA.

MLK founder Heinrich Lohmann has been active in the field of renewable energies since the early 1990s. He has been involved in the development of approx. 570 wind turbines and 800 megawatts of installed capacity. MLK itself has now implemented 100 plants with about 250 megawatts of capacity (directly and indirectly). An additional 300 MW are currently in the approval process.

At three sites, in North Rhine-Westphalia, Brandenburg and Berlin, and depending on the project, around 40 employees are in charge of planning, implementation, operational management and operations. What is special: after installation, MLK operates most of the plants itself. The fact that MLK retains a share in all new installations creates trust among municipalities and neighbours.

Participation for all neighbours

The MLK group is committed to direct citizen participation: Local people should be able to benefit from MLK wind turbines. MLK has developed several opportunities for citizens to participate with all social groups in mind, ranging from subsidised electricity tariffs for neighbours to direct opportunities to participate.

Thanks to the electricity tariff for neighbours, those living next to wind farms receive green electricity at prices that can even be lower than those of low-cost suppliers. For low-income neighbours and families with many children, the social tariff is even more favourable. In the ‘savings for citizens’ programme, savers receive interest at a rate of three percent per year – and this in times of low interest rates. More attractive and low risk ideas for citizens to directly benefit from the success of wind farms are in the pipeline.



MLK-Gruppe

Address	Lichtenberger Weg 4 15236 Jacobsdorf OT Sieversdorf
Phone	+49 (0)336 081 799 97
Fax	+49 (0)336 081 799 98
E-Mail	info@mlk-consult.de
Web	www.mlk-windparks.de
Category	Planning
Profile	Planers & project developers
Employees	40 (Wind energy: 40)
Founding year	2005

- 01 | Transport at night
- 02 | Cleaned up construction site
- 03 | Construction progress
- 04 | Bird protection

Monsson Operation GmbH

Your global service partner in the renewable energy market

As part of a selected group of companies which are all acting in the renewable energy market within well-defined fields, Monsson Operation GmbH is able to provide added value for a wide range of services either with own or group resources.



Installation for onshore wind turbines

The installation service may consider the supply of installation teams or the supply of both installation teams and crane services. In some cases, special transport can also be considered for taking over a turnkey project.

Operation and maintenance for onshore wind turbines

As the core service of Monsson, the O&M category includes the delivery of full or limited service agreements, as well as of selected stand-alone services. Such services include preventive and corrective maintenance, service and troubleshooting, blades and other rope access works, gearbox video-endoscopy and gearbox oil exchange, condition monitoring through vibration analysis, and inspection of wind turbine equipment.



EPC and operation and maintenance for solar power plants

The solar PV is a strong developed division within Monsson which is able to provide a wide range of services. It all starts with EPC contracts and continues with O&M and various other analysis, inspection and calibration services aimed to ensure a smooth operation of the solar power plant.

Remote monitoring for renewable assets

With two privately-owned remote monitoring and dispatch centers, Monsson is able to actively monitor 24/7 renewable power plants and transformer stations, and provide remote control, data analysis, as well as on-site teams coordination and support.

Photos: Monsson Operation



GWO and other industry trainings

Monsson's Renewable Energy School of Skills is the largest privately-owned training facility in South-Eastern Europe, fully certified and supported by BZEE and GWO. Currently, the facility provides various and complex training modules for both onshore and offshore technicians, with new trainings being periodically developed and implemented.



Monsson Operation GmbH

Address	Ballindamm 3 20095 Hamburg
Phone	+49 (0)403 010 4470
Fax	+49 (0)403 010 4299
E-Mail	germany@monsson.eu
Web	www.monsson.eu
Category	Operation & Service
Profile	Service, maintenance & repair

N.T.E.S. GmbH

Maintenance • Repair • Inspection • Optimisation

Service for wind turbines since 2000. Manufacturer-independent maintenance and repair across Germany using the latest technology.

N.T.E.S. GmbH Windkraftservice is a service provider in the wind energy sector.

What drives us: to provide top-level maintenance and repair – manufacturer-independent and across Germany.

Our competencies include MAINTENANCE, OPTIMISATION, INSPECTION, REPAIR, THERMOGRAPHY and MEASUREMENT. We are specialists for AN Bonus and Siemens turbines in the range of 150 kW to 2.3 MW.



Nearly 20 years of experience in the wind energy sector are an ideal foundation for achieving the best results both in repair and preventatively in maintenance or inspection. Our well-trained teams work across Germany.

Flexibility and fast response times are our key qualities.

Our services in brief:

- Maintenance** 24/7 trouble-shooting
- Repair** Recurring inspections (DGUV V3, crane, arrester and ladder inspections)
- Inspections** (blade and transmission inspections, blade assessment and damage analysis)



N.T.E.S. GmbH

Adress	Handelshof 8 27432 Bremervörde
Phone	+49 (0)4761 92612-0
Fax	+49 (0)4761 92612-99
E-Mail	wkas@ntes-service.de
Web	www.ntes-service.de
Category	Operation & Service
Profile	Service, maintenance & repair
Employees	30
Founding year	2000



Netze BW GmbH

wind power outlet

From engineering and approval planning to the construction of a turnkey transformer station, Netze BW division of services ensures wind farms feed into the 110kV grid efficiently.



Netze BW's "wind power outlet" is a standardized 110/30 or 110/20kV supply substation, which can be tailored precisely to the requirements of the respective renewable energy project by means of modular and performance-dependent components. It enables technically mature, cost-effective, direct supply to the high-voltage grid. The transformer station is constructed on a turn-key basis in just 10 months, including approval planning. Netze BW takes care of all the tasks involved, from planning and project development to construction and commissioning.

The services of Netze BW division of services at a glance:

- Planning, project development and construction of 110/30 or 110/20kV feeder substations or the entire wind farm infrastructure
- Planning, project development and construction of medium-voltage installations
- Construction of internal wind farm cabling
- Integration of the wind farm into the grid of the regional grid operator
- Management of all medium- and high-voltage plants with assumption of plant responsibility
- 24/7 on-call service and fault clearance for the wind turbines and wind farm infrastructure
- Certification of transformer station and wind farm

Ein Unternehmen der EnBW



Netze BW GmbH – Division of services

Adress	Schelmenwasenstraße 15 70567 Stuttgart
Phone	+49 (0)711 289-46000
Fax	+49 (0)721 914-20111
E-Mail	dienstleistungen-hs@ netze-bw.de
Web	www.netze-bw.de/ dienstleistungen
Category	Planning
Profile	Grids & grid connection
Employees	about 4200
Founding year	2014

Nölting GmbH – EXPERTEN FÜR VERTRIEBS- UNTERSTÜTZENDE KOMMUNIKATION

Our expertise lies in communications to support sales in the renewable energy sector. We'll lead you to your wind industry customers in the best and most exciting way.



01



Nölting GmbH – EXPERTEN FÜR VERTRIEBSUNTERSTÜTZENDE KOMMUNIKATION

Address	Gottesweg 127 50939 Köln
Phone	+49 (0)221 846 121-60
Fax	+49 (0)221 846 121-60
E-Mail	info@noelting.gmbh
Web	www.noelting.gmbh
Category	Other services
Profile	Media & Communication
Employees	1–5
Founding year	2010

The entire wind energy market in your pocket.

Nölting GmbH has been active in the wind energy market for over ten years. It has extensive expertise and successfully supports companies in sales and marketing within the international wind energy industry. We analyse markets to find appropriate sales channels or to expand existing ones, and coach our customers' staff to ensure the appropriate placement of products and services. One of our core topics is the implementation of communication concepts and the development of special formats, their implementation due to our tight cooperation with a wide variety of partners is guaranteed.

Digital marketing and lead generation are also becoming increasingly important. Integrate our moving marketing concept into your marketing strategy – and how about a digital sales representative who is available 24/7, 365 days a year?

01 | A leap into the future

NORD/LB

International presence with North German focus

With total assets of € 134 billion, NORD/LB Norddeutsche Landesbank is one of Germany's leading merchant banks.



Our ideas are extremely innovative – like the energy we invest in.

NORD/LB has been involved as a financier for projects in the renewable energy sector since the mid-1990s and has pioneered wind energy financing.

Having successfully advised and financed many on- and offshore wind as well as solar projects, we are one of the top arrangers for renewable energy project finance in the national and international markets. We support our customers in achieving their targets with our expertise, know-how and commitment. Based on this, we are able to provide a thorough assessment of each projects' opportunities and risks and offer each of our customers' tailor-made solutions for their individual financing needs.

Our services range from optimising financing structures and funding sources (including multi-lateral and Export Cover structures) to providing advice and support during any potential project sale. Having financed one of the largest renewable energy portfolios provides an indispensable added value when consulting and structuring future projects.

We provide these services by international teams in Hanover, Oldenburg and London as well as specialists in New York and Singapore.

01 | Breathtaking view: This wind turbine has a hub height of 149 meters.

02 | Spectacular: the NORD/LB building in Hanover.

NORD/LB

NORD/LB

Adress	Friedrichswall 10 30159 Hannover
Phone	+49 (0)441 237-1667
E-Mail	gerrit.schmidt@nordlb.de
Web	www.nordlb.de
Category	Finance & Law
Profile	Banks, financial institutions & financial service providers
Founding year	1970

NOTUS energy

Power on your side.

As an independent energy producer and project initiator we produce clean electricity. We plan, construct and operate wind farms and solar parks right from the initial concept to their final grid connection.



As an Independent Power Producer (IPP) we are therefore continuously expanding our wind and solar portfolio. This provides us with the financial independence we require to be able to invest in new projects and continue to grow the company.

Our ambition is to bring together the best professionals in the field. NOTUS energy is a flexible and financially strong partner for municipalities, planners, and investors. We are convinced that renewable energies result in win-win situations: sustainable investment, regional value generation and a future for our children.

Wind energy:

1.420 MW installed
6.470 MW under development
260 MW as managing owners
450 MW in operational management

Solar energy:

3.590 MW under development

200 employees, active in 15 countries

GENERAL CONTRACTOR: EVERYTHING FROM A SINGLE SOURCE

As one of Germany's leading general contractors for wind and solar energy we construct turnkey wind farms and solar parks around the world. Fast, flexible and on time: ISO 9001 certified.

ARTIFICIAL INTELLIGENCE: IMPROVED WIND FORECASTS AND POWER LOAD CALCULATIONS

Together with our partners, we are developing intelligent software solutions: for optimised wind forecasts, power load calculations and automated wind or solar power plant inspection using drones.

ASSET MANAGEMENT: A MODERN TAKE ON OPERATIONAL MANAGEMENT

As asset managers, we not only take on technical and commercial management roles but fully represent the owners in every way. By continuously optimising the technology as well as sales operations.



NOTUS energy

Address	Parkstraße 1 14469 Potsdam
Phone	+49 (0)331 62043-40
Fax	+49 (0)331 62043-44
E-Mail	windkraft@notus.de
Web	www.notus.de
Category	Planning
Profile	Planers & project developers
Employees	200
Founding year	2001



01 | NOTUS wind turbine at Milow wind farm

02 | NOTUS Headquarters in Potsdam

03 | Alexandra Trigo Villarreal, NOTUS Project Manager for international projects



PNE AG

Solutions for clean energy

Development, realisation, operation and management of wind farms – international, onshore and offshore.

Overview

The PNE Group is one of the pioneers in developing wind farms at sea and on land. Based on this success, we have developed into a “Clean Energy Solutions Provider.”

From initial site assessment and the implementation of approval procedures, financing and turnkey construction to operation and repowering at the end of the system’s useful life: Our range of services covers all phases of project planning and operation of wind farms.

- 01 | Altenbruch wind farm, Lower Saxony
- 02 | Gode Wind offshore wind farm, North Sea
- 03 | Chransdorf wind farm, Brandenburg
- 04 | Headquarters of PNE AG, Cuxhaven

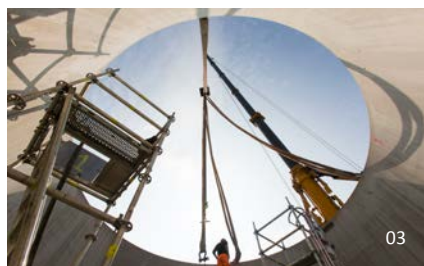

The entire portfolio of renewable energies

Wind energy is our core business. But we are doing all we can to achieve a sustainable energy supply and we offer an even broader value-added chain of renewable energies as well as the supply and delivery of power from renewable energy sources. Beyond that, we strongly expand our own operation of wind farms in the future.

In addition to wind energy, the company’s portfolio includes photovoltaics, electricity storage and power-to-X technologies with a focus on hydrogen.

The development of our different business segments is also accompanied by a regional expansion of our business activities: In addition to western industrialised countries, we are focusing our commercial activities on developing countries in Latin America, Africa and in both the Middle and Far East.



The more than 400 employees of the PNE Group dedicate themselves every day to moving one step closer to realising the vision of a world where energy demand is met solely from renewable energy sources. For clean, sustainable energy production – now and in the future.

Our references at a glance:
www.pne-ag.com



PNE AG

Adress	Peter-Henlein-Strasse 2–4 27472 Cuxhaven
Phone	+49 (0)4721 718 06
Fax	+49 (0)4721 718 200
E-Mail	info@pne-ag.com
Web	www.pne-ag.com
Category	Planning
Profile	Planers & project developers
Employees	approx. 400
Founding year	1995

R+V Allgemeine Versicherung AG

R+V offers comprehensive insurance cover for wind turbines

From planning and installation through to the operational phase, wind turbines require comprehensive insurance cover. This is now available all under one roof with R+V's new wind insurance concept.



01 | R+V consultant Jan Kehnappel with the customer Mr Petersen
 02 | First-hand knowledge all under one roof – AgrarKompetenzCenter



R+V Allgemeine Versicherung AG

Address	Raiffeisenplatz 1 65189 Wiesbaden
Phone	+49 (0)611 533 98751
E-Mail	AgrarKompetenzCenter@ruv.de
Web	www.ruv.de/firmenkunden/ erneuerbare-energien/wind-energie
Category	Finance & Law
Profile	Insurance companies
Turnover	€ 18.3 billion
Employees	15,000
Founding year	1922

R+V is part of the German cooperative banking group Volksbanken Raiffeisenbanken (VR), making it part of a strong alliance. What we offer our customers, in addition to the latest products and extensive knowledge, is our local presence. Across the 800 VR banks and their 8,500 branches, our customers find a named contact for all their insurance matters. You can be sure that we are always there for you.

First-hand knowledge all under one roof – AgrarKompetenzCenter

As one of the largest insurers for renewable energy plants, R+V has over 30 years experience in this field. To strengthen our position in the rapidly growing renewables market, we have bundled our knowledge and expertise in the Competence Centre for Renewable Energies. Our team of experts implements new product ideas

across all areas and continuously develops the existing product offer.

Our staff are always identifying the latest trends in the fields of wind power, solar energy and biogas in cooperation with leading companies and associations. Helping you make sustainable use of our solutions well into the future.

R+V insurance solutions for your wind turbines

Wind turbine operators are making an important contribution to the success of the energy transition. This way of generating power is especially climate-friendly and particularly lucrative – provided you are sufficiently well insured.

From planning and installation to the operational phase, R+V offers comprehensive cover all under one roof with its new insurance concept especially for wind energy.

Let us join forces at the early stages of your project so we can offer you the very best support and advice.

Agrar KompetenzCenter



Ramboll

World-leading wind consultancy

With our multidisciplinary capabilities and international expertise, we offer a full range of services that cover the entire life cycle of a wind energy project.

Ramboll is one of the top-ranking engineering consultants in Europe. We provide individualised services, supporting our clients in wind energy project development and implementation processes. Ramboll has a strong focus on understanding our clients' needs, and we strive to provide sustainable and long-term technical and commercial solutions to our clients.

In-depth knowledge and experience

With more than 30 years of consultancy experience from onshore and offshore wind projects, Ramboll has built up comprehensive knowledge and competencies within wind energy. We have performed designs for more than 60 offshore wind farms around the world, totaling more than 65 % of all installations. Within the field of onshore wind, we have provided expert services to wind farms with a nominal output of +60,000 MW in more than 60 countries.

Ramboll has the expertise to support our clients from due diligence and environmental studies over planning and construction to commissioning and operation of the wind farm and can provide assistance at every step of the project.

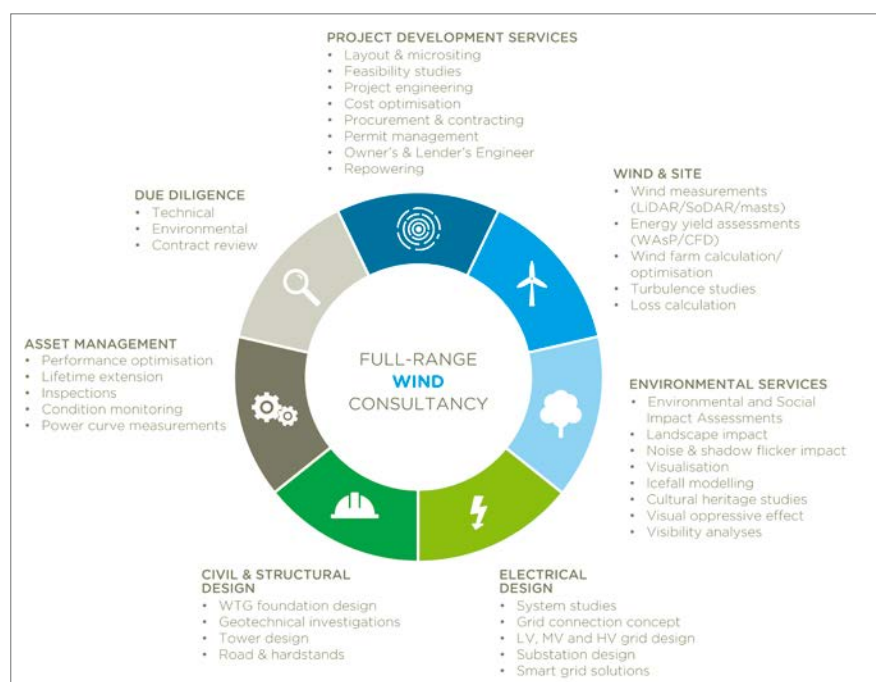

Access to global knowledge

With 300 offices in 35 countries, we strive to combine our local presence with our global resources and expertise. This means that our clients worldwide can get globally leading consultancy with an in-depth knowledge of local conditions.



Bright ideas. Sustainable change.

Ramboll

Adress	Chilehaus C – Burchardstraße 13 20095 Hamburg
Phone	+49 (0)40 302020-0
E-Mail	info@ramboll.com
Web	www.ramboll.com/wind
Category	Planning
Profile	Offshore
Turnover	€ 1.9 billion
Employees	16,500 ca. 350
Founding year	1945



RECASE Regenerative Energie GmbH

RECASE – Engineering Services for Wind Industry

- Development of wind turbines, projects and components.
- Individual solutions for the professional integration of third-party systems in WTG's (e.g. BNK, fire detection and extended data acquisition).
- Offshore engineering solutions for WTGs, foundation, substation and operation



Our main topics are:

- Development of electrical systems for wind turbines and wind farms (on-/offshore)
- Consulting and engineering for the grid connection of projects
- Engineering and integration of third party systems in WTGs, e.g. BNK, fire alarm systems, etc.

Examples from our field of activity:

- Development of the first commercially usable transponder BNK system. Within the company consortium "Lanthan Safe Sky GmbH", RECASE has played a decisive role in the marketable integration of the system into the wind turbines.
- Planning and implementation of the electrical system of the "nezy" floating offshore WTG. Our electrical engineering experts, together with the client and suppliers, specified the sensor technology and control of the prototype in theory and practice
- In cooperation with "Auctoritec GmbH" and "morewind GmbH" we offer continued operation tests for WT operation beyond the design life time of 20 years. Here RECASE applies its expertise in the analysis of SCADA data but also of supplementary meteorological data.

RECASE Regenerative Energien GmbH has been active in the market for 8 years and has since then successfully supported numerous on- and offshore projects in Germany and worldwide. A team with decades of experience in the wind industry, technical expertise and methodical competence is available for our customers. Our clients and customers are operators of wind farms, manufacturers of wind turbines and their components, energy suppliers and investors in renewable energy projects.

For each of these customer segments we offer an individually defined service package. RECASE acts solution-oriented and on an equal level with all parties involved.

- 01 | Service in the Wind Farm
- 02 | Lorenz-H. Carstensen and Maurice Graber
- 03 | Service on the Wind Turbine



RECASE Regenerative Energie GmbH

Address	Alte Landstraße 1 24866 Busdorf
Phone	+49 (0)4621 4216640
Fax	+49 (0)4621 4216 648
E-Mail	info@recase.de
Web	www.recase.de/home
Category	Other services
Profile	Development & construction



The RECASE team is available at your disposal to discuss and sharpen engineering tasks and to develop a technically and economically optimal solution.

Regenerative Energien Zernsee GmbH & Co. KG

Everything is changing – great!

Customers are demanding more, legislation have own ideas, and so do the authorities and business partners – ultimately, everyone wants to earn money. How can this work? REZ focuses on strong support, direct communications as well as dialogue within the industry and clear positions.

Whilst general concepts are good and useful, it is more important to adapt and develop them to meet specific circumstances. Customers are demanding more, legislation have own ideas as, of course, do the authorities, and business partners even more so – and, ultimately, everyone wants to earn money. How does it all work? REZ focuses on strong support and direct communications as well as dialogue within the industry and on clear positions in relation to politicians, grid operators and the tax authorities.

Above all, REZ delivers exactly what customers expect, i.e., technical and commercial management services for their wind farms. This can include specific tasks or taking on the entire management. Also site management with a dedicated on-site service, direct marketing or re-powering measures. And always with the objective of maintaining the highest possible availability and providing high returns for operators.

REZ is currently pursuing this objective for around 140 wind turbines and four transformer stations with a total rated output of about 310 megawatts, primarily in Brandenburg, Rhineland-Palatinate, Hesse, Saxony-Anhalt, and North Rhine-Westphalia.

But we also do more by acting as a permanent negotiating partner for service providers, or as a powerful voice in matters relating to energy policy, electricity taxation, reporting obligations or negative electricity prices, always in the interests



of our customers, which is reflected in their profitability and good bottom-line results.

To remain flexible, such issues as demand-controlled night-time identification (BNK) or bird and bat protection are tackled as early as possible, to which end REZ is a recognised member of the BWE's Operations Managers Advisory Board. We seek dialogue with industry colleagues, and regularly shares its own know-how in BWE seminars.

And by the way, our ISO 9001:2015 certified quality management system is regularly audited and confirmed.

01 | Windpark Jacobsdorf

REZ

Regenerative Energien Zernsee GmbH & Co. KG

Adress	Bergstraße 1 12169 Berlin
Phone	+49 (0)30 22 44 598 30
Fax	+49 (0)30 22 44 598 31
E-Mail	info@rez-windparks.de
Web	www.rez-windparks.de
Category	Operation & Service
Profile	Technical & commercial operational management

RoSch Industrieservice GmbH

OUR CHALLENGE WITHOUT LIMITS

We offer our clients worldwide a reliable, professional service for flawless, efficient operation of complete wind turbines, both on- and offshore.



ON- AND OFFSHORE

Our versatile service offerings are tailored to your individual needs. In addition to professional installation of your turbine, services also include regular maintenance as per manufacturer specifications, servicing procedures, a repair service for turbine components, and development of special, customized solutions. In the offshore segment, we also manage to excel with a well-positioned concept, and are thus also able to satisfy special requirements offshore.

As a certified, quality service provider, we complete extremely challenging tasks which require expertise and many years' experience. We adopt a flexible approach to clients' individual requirements and take the latest technological developments as a starting point at all times. In doing so, we keep an eye on turbines for the long term to provide a timely response to malfunctions during operation and prevent breakdowns.

Since April 2017, we are part of ROBUR Industry Service Group GmbH. From planning and implementation, to operation and maintenance, to the relocation and decommissioning of industrial plants, we are expert partners of our clients and assist them in optimising the life cycle of their plants. Together we benefit from the Group's size, internationality, services, synergies and continuous investment in technological progress.



RoSch Industrieservice GmbH

Address	Bernardstr. 29 49809 Lingen
Phone	+49 (0)591 800990-0
Fax	+49 (0)591 800990-19
E-Mail	info@rosch-industrieservice.de
Web	www.rosch-industrieservice.de
Category	Operation & Service
Profile	Service, maintenance & repair
Turnover	approx. € 10 million
Employees	100
Founding year	2008

Our employees' safety is a priority for us, whether they are on the ground or high up in the nacelle. We therefore invest heavily in work safety and certify our employees as per DEKRA guidelines and SCC regulations. Thanks to this high qualification standard, we are able to undertake challenging work on safety- and test-relevant components and structures in industrial plant installations.

Rosendahl & Frank Windtechnik GmbH

Experts for wind energy | Quality assurance for wind turbines

As an expert office for wind turbines, we have been working for the transformation to renewable energies for more than 10 years. We use our experience and impartial expertise to ensure that each and every wind turbine is operated for as optimally and as long as possible.

Every year, we inspect about 800 WTGs of various manufacturers and power classes. Especially for inspections of Enercon WTGs, numerous operators trust in our expertise. We are a member of the expert advisory board of the German Wind Energy Association (BWE) and our quality management is ISO 9001 certified.

Expert reports

With our manufacturer-independent expert reports and our experience, you can keep track of the condition of your wind turbine or wind farm. These inspections form the basis for the longest possible fault-free operation and high plant availability.

We would be pleased to carry out the following tests for you:

- Recurring inspections
- Rotor blade inspections incl. lightning protection measurement by rope access technique
- Lifetime extension reports
- Commissioning inspections
- Out of contract inspections (warranty)
- Condition-oriented inspections
- Vibration analyses (offline and online)
- Damage reports



02



01

- Technical due diligence
- Further tests such as endoscopies, thermographies, oil and grease analyses

Quality assurance

We offer customized individual concepts for the quality assurance of WTGs. We accompany you throughout the entire life of your plant and monitor the WTGs 24/7 from an expert perspective. Our expert reports do not only consist of a snapshot, but also include all operating states of the WTGs in the evaluation in order to optimize the operation of the plant.

01 | The RFW team

02 | Rotor blade inspection via rope access

03 | Enercon E-92



03

Lifetime extension

The continued operation of wind turbines beyond 20 years is a matter of concern to us. Therefore, we have set ourselves the goal of providing our customers with the longest possible economic operating time for their WTGs. We carry out the lifetime extension inspection for WTGs and are available as contact persons for questions regarding the further operation of WTGs.



**Rosendahl & Frank
Windtechnik GmbH**

Rosendahl & Frank Windtechnik GmbH

Address	Hermann-Scheer-Str. 1 26736 Krummhörn
Phone	+49 (0)4923 805 977 1
Fax	+49 (0)4923 805 977 2
E-Mail	info@rfw-gmbh.de
Web	https://windkraft-gutachten.de/
Category	Inspection bodies / measurement institutes
Profile	Technical consults
Employees	18
Founding year	2006

RWE Renewables GmbH

With new energy towards a sustainable future

RWE has been producing electricity with passion for over 120 years. Now RWE is shaping the new energy era. Following its realignment, RWE is now one of the world’s leading renewable energy companies. RWE is international, future-oriented and broadly positioned. Ideal conditions for clean, reliable and affordable electricity.



Current projects range from the completion of an 857 MW offshore wind farm in the UK to the commissioning of RWE’s 25th wind farm in North America, which supplies green electricity for 66,000 households. In Sweden, RWE Renewables is building the largest European onshore wind farm. In Germany, construction is beginning on the Kaskasi offshore wind farm north of Heligoland, which will be able to generate electricity for 400,000 households and for which contracts worth around €500 million have been awarded.

The RWE Renewables portfolio ranges from plant development and construction to operation and repowering.

As a driver of the energy transition, the RWE group is also focusing on innovative projects such as floating offshore and the production and use of hydrogen.

And RWE has a clear goal: to be carbon-neutral by 2040.

RWE

RWE Renewables GmbH

Address	Kruppstraße 74 45145 Essen
Phone	+49 (0)201 5179 5008
Fax	+49 (0)201 5179 5005
E-Mail	communications@rwe.com
Web	www.rwe.com
Category	Energy services
Profile	Construction, operation, direct marketing
Employees	approx. 3,500

RWE Renewables, the new subsidiary of the RWE group, has been one of the world’s leading players since its launch – for example, it is the global number two in offshore wind power. The company has onshore and offshore wind farms, photovoltaic plants and battery storage facilities with a combined capacity of approximately 9 gigawatts. RWE Renewables is driving the expansion of renewable energy in more than 15 countries on four continents. By the end of 2022, RWE Renewables aims to invest €5 billion net in renewable energy and to grow its renewables portfolio to 13 gigawatts of net capacity.



SATELL Rechtsanwälte Steuerberater Reppich PartmbB

SATELL – your reliable partner

SATELL is one of Germany's leading renewable energy law firms. In addition to special legal expertise, we have many years of experience and a comprehensive network of contacts in this sector.

Satelles (lat.) means the reliable and far-sighted partner. The name SATELL represents our programme.

As your direct contact, we will be at your side for all important decisions and will fully identify with your objectives. As well as being team players, all our lawyers are specialists in their field. We face the ever-new challenges of the changing energy market in collaboration with our clients. Project developers, energy producers, investors and banks rely on our expertise. We provide advice relating to on- and offshore wind power as well as solar and geothermal energy.

Our consultancy services cover the entire life cycle of power production plant. We regard ourselves as a one-stop-shop for companies and entrepreneurs within the renewable energy sector, covering everything from project development and funding to plant construction and operation as well as end consumer transactions. We also work on legal matters relating to electricity trading and distribution grids, energy efficiency and storage technology.

In addition to our legal expertise, SATELL clients benefit from our many years of market knowledge and our first-class network of contacts.



01 | Team Energy



SATELL Rechtsanwälte Steuerberater Reppich PartmbB

Adress	Nymphenburger Straße 4 80335 München
Phone	+49 (0)89 558903-0
Fax	+49 (0) 89 558903-399
E-Mail	info@satell.de
Web	www.satell.de
Category	Finance & Law
Profile	Lawyers
Founding year	2010

SCADA International A/S

Empowering a renewable future

SCADA International supports customers around the world to execute projects at any point in the SCADA value chain. With more than 6000 SCADA solutions installed, the customer range encompasses manufacturers, utilities, asset owners and independent power producers, among others.

Removing barriers among data and technology

Businesses depend on data to optimize performance and operations, and since SCADA International's foundation, we have been developing solutions to enable data access. We believe that anticipating tomorrow's problems will solve today's difficulties. Therefore, our intelligent software solutions make data reliable from various sources available in real time to customers worldwide. We strive to reduce complexity and provide our customers with solutions that optimize performance and competitiveness, and facilitate information exchange among databases and technologies.



Covering the full SCADA value chain

Data is at the core of any machine – it is a key ally to secure and extend its lifespan. Thus, at SCADA International, we cover the full SCADA value chain – from SCADA hardware and software, installation, and commissioning into consulting. Our highly skilled specialists support the value chain at any point, ensuring efficient and cost-saving solutions for our customers.

Committed with the wind industry

SCADA International stands for building an open-source architecture and technology environment to ensure interoperability for the wind industry systems. We are committed to facilitating energy transition through data and find tomorrow's problems, identifying new opportunities, and developing innovative solutions to support our customers' business growth.

SCADA International at a glance

Headquartered in Denmark, SCADA International employs close to 100 SCADA specialists at offices in Germany, Poland, Ukraine, United Kingdom and the USA. The company is certified according to ISO 9001, ISO 14001 and ISO 45001.

SCADA International accounts for more than 6.000 SCADA solutions installed across 29 different countries. The organization specializes in renewables, and focuses on developing intelligent data solutions to streamline operations and reduce the Levelized Cost of Energy (LCoE).



SCADA International A/S

Adress	A. C. Illums Vej 4A DK-8600 Silkeborg
Phone	+45 (0)9641 9200
E-Mail	scada@scada-international.com
Web	www.scada-international.com
Category	Other services
Profile	Software solutions

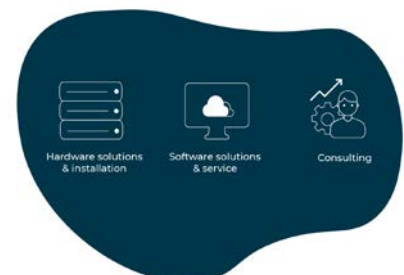

Statkraft Markets GmbH

A secure future for your renewable energy asset

As the market leader in direct marketing, Statkraft is a powerful partner who will support you in the market in the long term – even after the EEG subsidy has expired.

With a pioneering spirit, Statkraft is pushing ahead with the technical and economically viable integration of renewable energies. More than 125 years of experience as an operator of own power plants, in project development and in trading create the best conditions for the reliable marketing of renewable generation capacities. In addition to standard services such as production forecasts, selling power on the spot market and balancing, we are always at our customers' side in a spirit of partnership to facilitate their day-to-day energy activities – even beyond the EEG subsidy period.

Continued operations after 2020

The continued operation of wind farms beyond the expiry of the EEG subsidies is one of the key topics in the coming years – not only for operators and owners of wind farms. Statkraft already offers viable and long-term power purchase agreements that ensure the continued profitable operation of existing plants even after the subsidy has expired. We purchase electricity from our customers on fixed terms, thereby assuming commercial risks and enabling our customers to continue operating their plants.

Our team is a reliable partner with sound know-how. Statkraft makes all this possible not only for your wind farms that are running out of subsidies. With our long-standing expertise, we also enable you to generate additional revenues from marketing the flexibility of your wind turbines, batteries and with e-mobility solutions.



Please do not hesitate to contact us if you have any question about direct marketing or specifically about the continued operation of your plants after 2020. Hopefully, we will meet again soon in person at wind industry days and trade fairs. Just have a look at the calendar on our website.

01 | The Statkraft direct marketing team: we make it possible!

02 | With early planning for financial security and long-term continued operation.



Statkraft Markets GmbH

Address	Derendorfer Allee 2a 40476 Düsseldorf
Phone	+49 (0)211 60 244-4404
E-Mail	direktvermarktung@statkraft.de
Web	www.statkraftdirektvermarktung.de
Category	Direct marketing
Profile	Direct marketers
Turnover	€ 25.2 billion
Employees	480
Founding year	1999

Sterr-Kölln & Partner mbB

Clear solutions for a sustainable energy future!

Sterr-Kölln & Partner uses its extensive know-how to answer the legal, economic and tax questions of projects in the field of renewable energies and to bring them in line with the strategic challenges of its clients.

As an **owner-managed, independent consultancy**, we place our work at the service of efficient and environmentally friendly resource use. We consider energy along the entire value chain, with decentralised energy generation and consumption as our guiding principle. Above all, regional value creation is close to our hearts, which is why we particularly focus on onshore projects.

Our understanding of consulting goes beyond an interdisciplinary approach, and solutions are developed based on consideration of all factors. By **integrated consulting** we mean the balanced use of proven consulting methods as well as holistic consideration of all legal, tax and economic aspects – always with the overriding goal of developing and implementing a sustainable strategy together with our clients.

Within this holistic understanding of consulting, we offer our clients a **wide range of services** and are also available to answer questions on smaller issues.

- Structuring, negotiation and drafting of project and purchase agreements
- Design of strategic collaborations
- Subsidy consulting
- Financial and commercial due diligence
- Legal and tax due diligence
- Corporate finance and project finance
- Public participation and crowdfunding
- Development of new marketing models
- Review and support of public law approval processes
- Corporate and tax structuring of project companies
- Advice on all questions of energy regulation law
- Legal advice on liability and warranty issues





Together with our team in Paris, we successfully implement **cross-border wind projects**. The French government's energy policy goal of increasing the share of renewable energy sources to 32 % by 2030 makes the market particularly lucrative for international investors. Our team in Paris has extensive knowledge of the market and is proactive in finding the right strategy for our clients to successfully implement their wind project in France. Through the close cooperation of our French and German lawyers and consultants, we ensure that your project is supervised and implemented with the highest quality.

We see the networking of individual energy sectors as an important component of the energy transition and of the future energy system. Accordingly, together with our partners, we increasingly advise our clients in the area of **sector coupling**.

With various feasibility studies we support the introduction of **green hydrogen** into the energy system. Here, too, we see the solution in decentralised generation, i.e. producing renewable electricity locally. When the EEG support for the first wind farms expires in 2021, a veritable market for renewable electricity from post-EEG plants will open up. Decentralised hydrogen production will increase the demand for green energy, as it will secure the entry into a clean, CO₂-free hydrogen economy.

Our references in brief

We are pleased that since 1994 our team of experts from the fields of law, tax and management has been able to shape the future of renewable energy together with our clients. We accompany your project from its strategic conception to the development and final implementation stages, and are also available as an experienced partner during operation. We have already provided integrated advice on over 300 wind projects with an investment volume of over 10 billion euros.

Feel free to approach us!

- 01 | Franziska Benz, Managing Director
- 02 | Heribert Sterr-Kölln, founder
- 03 | Steffen Kölln, Managing Director

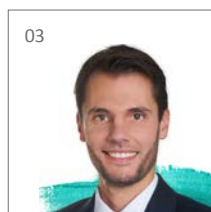

Sterr-Kölln & Partner mbB

Adress	Emmy-Noether-Straße 2 79110 Freiburg
Phone	+49 (0)761 490540
Fax	+49 (0)761 493468
E-Mail	info@sterr-koelln.com
Web	www.sterr-koelln.com
Category	Finance & Law
Profile	Consulting & business consulting
Employees	40 (Wind energy: 25)
Founding year	1994

STEIL KRANARBEITEN GMBH & CO. KG

Heavy things – moved easily!

We tackle difficult tasks with many years of experience, trained employees, and a highly specialised fleet of more than 100 cranes. We serve our customers throughout Germany and around the world from our 5 bases distributed throughout the Saar-Lor-Lux region.



ing the best possible, most cost-effective solution. We also provide our customers with a complete service range and take care of all necessary details, from feasibility studies, crane engineering, and the selection of suitable resources to approvals and CAD planning.



Deployed throughout Western Europe for you

Always at the centre of everything we do are safety and quality. We can look back on many years of experience both at home and abroad, especially in the construction of wind power turbines. The skills of our crane operators as well as our office-based and field staff play a crucial role in this, because wherever heavy loads need to be moved safely and precisely, the designers and project engineers involved have to rely on our expertise.

With our highly specialised vehicle fleet, we are well equipped to meet the technical challenges of the future. We collaborate with a large number of subcontractors throughout Western Europe, some of whom can be reached quickly from other regions, always with the objective of find-

01 | Precision work
02 | Wind energy

03 | Blade lifter
04 | Wind energy



STEIL KRANARBEITEN GMBH & CO. KG

Address	Auf dem Adler 3 54293 Trier
Phone	+49 (0)651 146560
Fax	+49 (0)651 14656-50
E-Mail	info@steil-kranarbeiten.de
Web	www.steil-kranarbeiten.de
Category	Transport & Logistics
Profile	Crane companies, crane hire & special transport
Employees	200
Founding year	1924

TOP seven GmbH & Co. KG

Fast, precise, efficient: Artificial intelligence (AI) enables automated drone inspection for the first time

Drones are increasingly being used as an alternative to the inspection of wind turbines by industrial climbers. TOPseven takes drone technology to a new level: With the aid of proprietary software, our drones fly autonomously, document damage and detect defects in lightning protection.

Whether it is commissioning, recurring inspections, stocktaking or repairs, wind turbine inspections are personnel-intensive, weather-dependent and cause downtime. While drones can improve this situation, they usually have to be flown by specialists and generate images that are difficult to analyse.

TOPseven has perfected drone deployment for **on- and offshore wind turbines** using its own AI-based control and analysis solution. Commercially available industrial drones use our software to fly along automatically calculated flight paths in a completely **autonomous** manner and generate precise, coherent images of high and consistent quality independent of weather and light conditions.

Minimum training required: AI-controlled monitoring of the autonomous drone enables flight without the use of specialised pilots. Industry standard compliant damage characterisation analysis and reporting takes place in the AI-based TOPseven Cloud.

Fast & flexible: the turbine only needs to be stopped once for the optical inspection of all rotor blades, the tower, and the lightning protection system. In the event of downtime due to weather conditions, the drone automatically continues the inspection from exactly the same position with no loss of time.



Simple & transparent: all damage is recorded with exact positional data. Long term life-cycle observation at the same location produce historic comparative images that enable the observation of the development of anomalies or repair.

Efficient analyses: the AI-controlled camera delivers seamless, high quality images of four sides of the rotor blades with minimal overlaps.

Unique, worldwide patented lightning protection mensuration: in just a few minutes the drone inspects the lightning protection system without coming into contact with it. Special sensors detect defects and can localize any interruptions exactly.

TOP7

MAKING DRONES SMARTER.



01 | TOPseven – drone

02 | TOPseven – headquarters

TOP seven GmbH & Co. KG

Address	Schiffbauerweg 1 82319 Starnberg
Phone	+49 (0)8151 95966-0
E-Mail	info@topseven.com
Web	www.topseven.com
Category	Operation & Service
Profile	Service, maintenance & repair
Founding year	2020

TÜV NORD EnSys GmbH & Co. KG

Full-Service Provider for the Wind Industry

TÜV NORD certifies on- and offshore wind turbines to all international standards and regulations, evaluates specific site conditions and supports operation of wind turbines over their entire lifecycle.



With more than 13,000 employees and experts in nearly all technical disciplines, TÜV NORD GROUP is one of the world's largest technical service providers.

We owe our leading market position to our technical competence and a wide range of services in the field of consulting, testing and certification. TÜV NORD GROUP operates in over 70 countries worldwide.

Within the field of wind energy, TÜV NORD offers services in certification, site assessment and inspection for on- and offshore wind turbines and projects. TÜV NORD is one of the leading accredited certification bodies for wind turbines certifying on- and offshore wind turbines according to all major guidelines such as IEC, IECRE, DNVGL, EN, GL, the Danish approval scheme, TAPS and BSH.

Type certification includes the design assessment of loads, safety concept and all components of the wind turbine. Major components such as gearboxes and rotor-blades can also be certified individually.

Besides the well known type certification for manufacturers and project certification for project developers, all services for wind energy projects can also be offered as a one-stop shop. The entire range of site assessment services including life time extension is available to wind farm planners, operators and providers of finance.

As TÜV NORD is accredited by the German Accreditation Body ("DAkKS"), TÜV NORD's bankable yield reports serve as a basis for financing projects in the field of wind energy. Additionally, TÜV NORD is an accredited inspection body ("ZÜS") for service lifts and pressure equipment by the German Industrial Safety Ordinance ("BetrSichV").

TÜV NORD supports wind energy projects as a competent and reliable partner throughout the entire lifecycle.



TÜV NORD EnSys GmbH & Co. KG

Address	Große Bahnstr. 31 22525 Hamburg
Phone	+49 (0)40 8557 0
Fax	+49 (0)40 8557 2552
E-Mail	windenergy@tuev-nord.de
Web	www.tuev-nord.de
Category	Inspection bodies / measurement institutes
Profile	Wind resource evaluators



The Who's Who of the German wind industry

Your company is not listed in the publication?
 You'd like to be included again next year?
 Then don't hesitate!



Specification:

Company profile and/or Address entry

- in the print publication
- as pdf
- and in the online database

Free distribution around the world at trade fairs and conferences

Free copies for your own marketing

We'll be glad to advise you:

Klaus Barkeling:
 k.barkeling@wind-energie.de
 Nikos Fucicis:
 n.fucicis@wind-energie.de



Published in German and English.

UKA – Umweltgerechte Kraftanlagen GmbH & Co. KG

The wind- and solarfarm developer

UKA plans, constructs, manages and operates wind and solar farms as well as the associated infrastructure. With some 50 grid-connected wind farms and a project pipeline of about 4 GW, UKA is one of Germany's leading onshore wind farm developers, but also implements solar energy projects.

Complete solutions for decentralised power production

As a full-service provider, the UKA Group, which was founded in 1999, provides all services up to the handover of operationally-ready energy parks. At the point of commissioning, our subsidiary UKB Umweltgerechte Kraftanlagen Betriebsführung GmbH ensures that the turbines will operate for decades with optimal technical and economic performance.

Our subsidiary UKA Projektträger GmbH & Co. KG, which is based in Lohmen (Mecklenburg), is responsible for the implementation of all of the UKA Group's construction projects. Due to our large purchasing volume, UKA is able to work in a particularly cost-efficient manner and can offer its services to external customers as well – a win-win situation for all parties.

All projects are accompanied up to permit-compliant implementation, which involves providing support for everything from the construction of pathways and foundations to grid connection, turn-key construction and commissioning to following up on all official requirements and acceptance tests in compliance with the German Federal Emissions Control Act (BImSchG).





As an expert for wind energy in forested locations, UKA has already commissioned several wind farms in commercial forests. The Group also successfully implements repowering projects and provides support for collaboration partners throughout all project phases.

The UKA Group currently employs over 600 people at our various sites in Meissen, Cottbus, Rostock, Lohmen in Mecklenburg, Erfurt, Magdeburg, Oldenburg, Bielefeld, Grebenstein (near Kassel) and Hanover. In addition, we are currently expanding our business activities in other European markets and have opened an office in Madrid for our subsidiary UKA-Iberia S.L.U. Our subsidiary UKA North America LLC, which is based in Stuart, Florida, is also working on promising renewable energy projects in the USA.

- 01 | UKA wind energy park in Barkow
- 02 | UKA offices
- 03 | Planning – construction – management – operation: Full service from a single source
- 04 | Renewable energies in harmony with nature



Der Energieparkentwickler

UKA – Umweltgerechte Kraftanlagen GmbH & Co. KG

Adress	Dr.-Eberle-Platz 1 01662 Meißen
Phone	+49 (0)3521 72 80 60
Fax	+49 (0)3521 72 80 6410
E-Mail	zentrale@uka-gruppe.de
Web	www.uka-gruppe.de
Category	Planning
Profile	Planers & project developers
Employees	600
Founding year	1999

VERBUND

VERBUND. Your strong partner in marketing your old and new plants.

Today, the biggest challenge is the integration of renewables generated by subsidised and non subsidised plants. We offer flexible generation marketing, storage and pool solutions as well as additional revenues as a result of convincing service concepts.



Maximum planning security and fixed revenues

Since 2016, direct marketing of new generating plants from 100 kilowatts upwards has been mandatory under the German Renewable Energy Sources Act (EEG). As a trading subsidiary of the largest power company in Austria, VERBUND Energy4Business Germany takes care of the direct marketing of green electricity for plant operators throughout Germany.

As experienced actors in the European electricity market, we have the necessary know-how for facing the challenges in this dynamic environment together.

The offer:

- Optimal green electricity marketing in intraday, spot and futures markets
- Long-term marketing concepts for plants older than 20 years
- Local certificates as an additional source of revenue for operators and municipal utilities
- Many years of expertise in forecasting
- Networking in the virtual VERBUND power plant
- Registration and change of registration of plants
- Participation in the electricity balancing market
- Individual terms for contracts
- PPAs

- 01 | VERBUND wind farm near Vienna
- 02 | VERBUND. Your strong partner for marketing your green electricity.
- 03 | Let's drive the energy transition together!



02

The advantages:

- Favourable prices due to optimal electricity marketing and a flexible power plant park
- Surplus compared to EEG feed-in remuneration
- Compensation for outages in the case of reduced feed-in capacity
- Financial security due to excellent creditworthiness
- Personal points of contact in Munich & Düsseldorf

VERBUND – Europe’s green battery

With our flexible power plant park of 8,200 megawatts, VERBUND is the largest hydroelectricity producer in Austria and Bavaria. This is ideally complemented by VERBUND’s own wind turbines and those marketed for third parties.

Flexible products

The generation portfolio consisting of hydropower and wind power is the basis for flexible products that are geared entirely to the market’s needs. Companies receive electricity, energy-related products and services as required combined with innovative solutions for efficient energy use.



03

Verbund

Am Strom der Zukunft

VERBUND

Adress	Sonnenstraße 17 80331 München
Phone	+49 (0)89 890 56 21933
Fax	+49 (0)89 890 56 21950
E-Mail	direktvermarktung@verbund.de
Web	www.verbund.de
Category	Direct marketing
Profile	Direct marketers
Turnover	€ 2.94 billion (Q1/2019, VERBUND AG)
Employees	about 3,150
Founding year	1947

Volkswind GmbH

Production of clean and renewable onshore wind energy

Volkswind has been one of the leading wind energy producers in Europe since 1993. Its core business comprises the planning, projection, construction and operation of wind turbines.



The Axpo Group produces, trades and distributes energy reliably in Switzerland and in over 30 countries throughout Europe, the United States, and Asia. Around 5,000 employees combine the expertise from 100 years of climate-friendly power production with innovative strength for a sustainable energy future.

Axpo is a global leader in energy trading and the development of customized energy solutions for its clients. Axpo's energy know-how and its market and industry experience ensure a strong strategic partnership in the wind energy sector.

Besides a further expansion of the business activities in the core markets Germany and France this partnership comprises also the expansion of the operational management and asset management.

Being a pioneer of the German wind energy business with over 1,100 MW realized wind energy Volkswind is nowadays one of the leading European developers and operators of onshore wind farms. This comprises a diversified portfolio with regards to geographies as well as clients.

After the take-over by the Swiss utility Axpo in 2015, Volkswind is even stronger positioned in the market for the further expansion and diversification of its project portfolio, also with view to regulatory changes in the energy market.



Volkswind GmbH

Address	Gustav-Weisskopf-Str. 3 27777 Ganderkesee
Phone	+49 (0)4222 94138-0
Fax	+49 (0)4222 94138-99
E-Mail	info@volkswind.de
Web	www.volkswind.de
Category	Planning
Profile	Planers & project developers
Employees	85
Founding year	1993



VSB Group

Project development, Planning, Construction, Operational Management, Maintenance

Trust in more than 25 years of experience and more than 1.000 megawatt installed capacity. We provide profitable solutions throughout the entire value chain of wind energy projects.

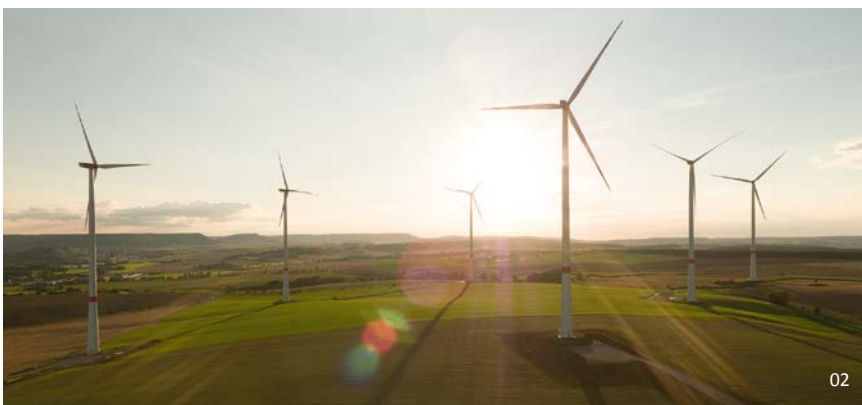

Wind is our passion and project development is our core competence. We accompany every step from securing land through approval planning to the implementation of wind farms, for which we are also your contact when it comes to technical and commercial management as well as maintenance and repairs. Choose between the whole package with VSB as a general contractor or a tailored set of individual services. To prepare for the electricity market of tomorrow, we also focus on storage solutions for matching demand and supply of renewable electricity.

Empathy and Acceptance

The energy transition can only succeed if all stakeholders act in concert. Therefore, our projects are put into practice in close cooperation with residents, municipalities, and local representatives. This results in highly individual solutions regarding turbine locations, windfarm layouts and compensation measures. Above that, scheduled receipts and financial rewards for citizens add to making renewable

energies a long-term benefit for local communities.

Tested Quality

VSB has received certification according to the DIN EN ISO 9001:2015 in Germany and France. What does this mean for our everyday business? It ensures that responsibilities are clearly assigned, processes are bindingly defined, and knowledge is documented in a systematic manner. Hence, you can put your trust in legal compliance, reliable yield projections and a strict monitoring of project costs.

In Your Vicinity

Climate action does not stop at regional borders. Consequently, our experts work internationally on implementing a sustainable energy supply. With our headquarters in Dresden and four regional German offices as well as numerous locations abroad we are always in reach when accompanying your project from the beginning to the end.

01 | Regional Value Added: Wölkisch wind farm (Saxony, 20.5 MW)
02 | Wipperdorf wind farm (Thuringia, 14.4 MW)



VSB Group

Adress	Schweizer Straße 3 a 01069 Dresden
Phone	+49 (0)351 21183-400
Fax	+49 (0)351 21183-44
E-Mail	info@vsb.energy
Web	www.vsb.energy
Category	Planning
Profile	Planers & project developers
Employees	more than 300
Founding year	1996

windcomp GmbH

Optimize and protect your wind turbine with the ROMEg measuring system

windcomp GmbH is specialized in the optimization of wind turbines. We have developed the ROMEg measuring system, with which we can quickly detect both aerodynamic and mass imbalances. It is a dynamic measuring process during normal plant operation.

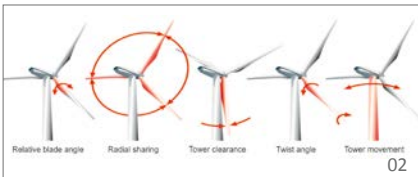

- 01 | Measurement parameters
- 02 | Profiles with blade angle deviations and without blade angle deviations
- 03 | Tower vibrations with a blade angle deviation and without blade angle deviation
- 04 | Romeg setup

windcomp develops and produces laser measuring systems for wind turbines and offers as a service the measurement of the turbines through our experts.

ROMEg is a laser-based measuring system for dynamic measurements on wind turbines. ROMEg can detect and measure aerodynamic imbalances, caused through blade angle deviations, as well as mass imbalances.

FUNCTIONS OF THE ROMEg SYSTEM

The following parameters and functions are measured by ROMEg System:

- Relative Blade angle – The main function of the ROMEg system is the measuring and determining of the relative blade angle deviations.
- Detection of mass imbalances.
- Tower vibrations – The oscillation pattern of the axial tower movement is a good indicator for the evaluation of the detected blade angle deviations.
- Vibration analysis of the tower movement (FFT Analysis).
- Tower clearance

ADVANTAGES OF ROMEg SYSTEM

- The laser measurements take place on a running turbine under real operating conditions.
- No loss of yield due to downtimes.
- Fast measuring process – whole wind farms within a short time. Results are quickly available on site and can be used immediately to optimize the turbine.
- By comparing the vibration pattern before and after the correction, the success of the optimization is immediately visible and provable.

WHY MEASURE?

In contrast to an imbalanced turbine, a turbine with well-balanced rotor shows the following attributes:

- Better performance/higher yield
- Higher availability
- Longer service-life of turbine
- Less tower stress
- Reduced maintenance costs
- Lower acoustic emission

The ROMEg system can be used as a ground and nacelle version and can therefore also be used for offshore turbines.

windcomp

windcomp GmbH

Address	Glogauer Str. 21 10999 Berlin
Phone	+49 (0)30 319 85 54 75
Fax	+49 (0)30 319 85 54 99
E-Mail	info@windcomp.de
Web	www.windcomp.de
Category	Operation & Service
Profile	Service, maintenance & repair
Founding year	2008

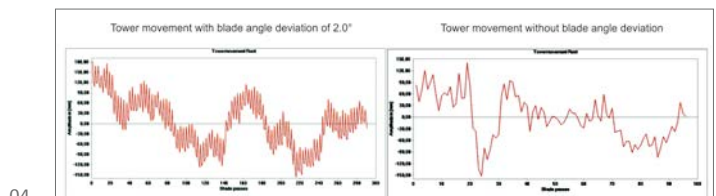
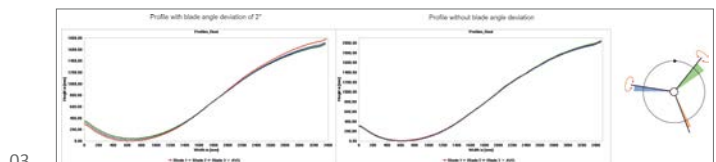

Windwärts Energie GmbH

Experts for wind energy with a level-headed northern German approach

Windwärts is among the wind energy industry pioneers with over 25 years of experience. We approach all our projects with a healthy degree of northern German level-headedness to guarantee our customers lasting success for their wind and solar energy projects. That is a powerful mix!

Creating great things together

Our core business is project development and operational management for wind and solar energy projects. Our project development activities are focused on Lower Saxony, Schleswig-Holstein and the Ostwestfalen-Lippe region. Our operational management services ensure the best possible results throughout Germany. Windwärts has already connected 187 wind turbines to the national grid with a total rated output of 363 megawatts. Our plant management team is responsible for a total rated output of over 700 MW.

It is all about people

We place particular importance on transparent project development, open and active communications with local residents and close collaborations with local authorities and landowners, whereby proximity to people is a particular concern for us.

A passion for performance

We are fascinated by the fact that wind and solar energy are infinitely renewable. We are motivated to use these elements in a sustainable way in the service of a climate-neutral energy supply, which is why we develop a diverse range of projects in the renewable energies field – with passion, heart, and intelligence.

A very capable partner at your side

Windwärts has been part of MVV Energie AG, one of Germany’s leading energy companies, since 2014, a group within which we bundle our competences and create solutions. In one recent example Windwärts partnered with MVV and juwi to use our shared MVV 20 plus products to ensure the economic continuation of post-EEG operations.



- 01 | Operational management: Your turbine in the best hands
- 02 | From A to Z: We make your project a success



Windwärts Energie GmbH

Adress	Hanomaghof 1 30449 Hannover
Phone	+49 (0)511 123573-0
Fax	+49 (0)511 123573-190
E-Mail	info@windwaerts.de
Web	www.windwaerts.de
Category	Planning
Profile	Planers & project developers
Employees	100
Founding year	1994/2014

WKN GmbH

From Husum to the whole world – Wind farm project development with WKN

As a part of the PNE Group the WKN operates internationally and has been making a significant contribution to the energy revolution for 30 years. Following the start-up phase, WKN expanded steadily into foreign markets and now has branches and joint ventures in Germany, Europe and South Africa.



01

01 | The WKN team: your partner for development of wind farms

02 | Laperrière wind farm, France

Around 150 employees at nine locations work together every day to implement global wind projects. In all, more than 1,900 MW have been realised with more than 900 wind turbines.

Our service spectrum ranges from site development to planning and financing and from construction and operation to technical and commercial management, thus covering all aspects of project development and wind farm operation. In addition to wind energy, the PNE Group’s portfolio includes photovoltaics, electricity storage solutions and power-to-X technology with a focus on hydrogen.

We consistently rely on long-term strategies and partnerships with local service providers while attaching great importance to cooperative relationships. With high demands on ourselves and many years of expertise, we realise high-quality projects together with our partners. The positive cooperation between our experts and the various stakeholders is an important basis for advancing clean energy projects. Our ultimate goal is to find optimum solutions that serve the interests of all parties involved, e.g. landowners, municipalities, investors and service providers.

WKN GmbH is a wholly owned subsidiary of PNE AG. The PNE Group is a globally active pioneer in the field of onshore and offshore wind farms and is developing into an international provider of clean energy solutions.



WKN GmbH

Address	Otto-Hahn-Straße 12–16 25813 Husum
Phone	+49 (0)4841 8944-100
Fax	+49 (0)4841 8944-225
E-Mail	info@wkn-group.com
Web	www.wkn-group.com
Category	Planning
Profile	Planers & project developers
Employees	about 150
Founding year	1990



02

Wölfel Wind Systems GmbH

How do you make profits with knowledge?

We are experts in vibration and signal analysis, provide information on structural damage, lifetime consumption and the associated potential continued operation, monitor material fatigue and help you meet legal requirements in the field of noise emissions.

High vibration levels, varying wind speeds or noise emissions – onshore and offshore, a wide variety of areas require professional engineering in order to make the operation of wind turbines (WTG) safe and efficient and to comply with licensing requirements.

By reliably detecting ice build-up, our **IDD.Blade®** ice detection system impressively reduces the downtime of your WTG. With **SHM.Tower®** and **SHM.Foundation®** you are best prepared for the topic “continued operation”. With exact information about the structural condition of foundation and tower, you can achieve a precise asset evaluation and an optimized lifetime extension.

The use of AI enables a new dimension of damage detection at the foundation. With **SHM.Foundation individual**, we are the market leader in the German offshore sector and offer customized solutions for foundation monitoring that enable condition-based inspections.

Low-frequency vibrations of the entire WTG can cause high stresses on the tower and thus significantly reduce the lifetime of the tower structure. Furthermore, if the vibrations are too high in the assembly state, e.g. the installation of the rotor blades may become impossible or may only be carried out in weather conditions that are very limited in time. Especially resonant vibrations can be reduced (cost-) effectively by our **TMD.Tower dampers**.



Noise-reduced operation can massively reduce the yields of your wind farm. With **ADD.Sound®** you minimize tonalities and return to normal operation mode. With more than 800 systems on the market, we can justifiably call ourselves a technology leader in active solutions for reducing gearbox tonalities.

01 | How do our blades give you a cutting-edge?

02 | How can you hear ice grow?



Wölfel Wind Systems GmbH

Address	Max-Planck-Straße 15 97204 Höchberg
Phone	+49 (0)931 49708-0
Fax	+49 (0)931 49708-150
E-Mail	info@woelfel.de
Web	www.woelfel.de
Category	Inspection bodies / measurement institutes
Profile	Technical consultants
Employees	110
Founding year	1971

wpd windmanager GmbH & Co. KG

5,259 megawatts in operational management

On course for growth: 2020 is characterised by growth at wpd windmanager GmbH & Co. KG, Germany’s leading and internationally expanding company in the commercial and technical management of wind farms and solar projects.

wpd windmanager is growing – with new locations, new target markets and new services. In 2020, five more offices were added: two nationally in Ereklenz and Bremerhaven, and three more internationally in Valladolid in Spain, Los Ángeles in Chile and Piteå in Sweden.

“Worldwide, we now manage 513 wind farms with 2,445 wind turbines and a total output of 5,259 megawatts,” says Nils Brümmer, Managing Director at wpd windmanager. “This makes us not only the market leader in Germany, but also one of the major players internationally in the field of operational management.” In addition to the core market in Germany, wpd windmanager is active in various other European countries, in North and South America as well as in Asia.

International growth: Around 2 gigawatts in operational management

In 2020, wpd windmanager added three new target markets with large volumes in parallel. With 71 MW in Sweden, 177 MW in Spain and 370 MW in Chile, the international portfolio under operational management will grow to almost 2 gigawatts in the long term. “For us, it is quite an extraordinary situation to implement structures for three new target countries at the same time. Especially as we are also growing continuously in other countries such as France, Finland, Croatia or Poland”, explains Henning Rüpke, responsible for international business development. “However, we are fully on track here and have expanded both the local teams and the investor relations department accordingly.”

- 01 | The Bremen-based company has been providing all services related to wind farm management since 1998.
- 02 | wpd windmanager monitors the turbines in its 24/7 control room.
- 03 | wpd windmanager now operationally manages a total of 5,259 megawatts.





04



05



06

National growth: Erkelenz and Bremerhaven

wpd windmanager is also expanding nationally. Through the integration of psm Nature Power Service & Management GmbH & Co. KG with more than 60 employees, a new wpd windmanager centre of competence for photovoltaics and continued operation was created in Erkelenz. “Our goal is to offer our customers the operational management of wind farms and solar farms from one source”, explains Ian-Paul Grimble, Managing Director at wpd windmanager. “We see a lot of potential, especially in the PV sector.” About 100 solar farms are already operated by wpd windmanager. Following the new location in Erkelenz, wpd windmanager opened another office in Bremerhaven in mid-2020.

04 | The in-house field service ensures that turbines are operating smoothly.

05 | wpd windmanager also has its own repowering division.

06 | wpd windmanager operationally manages around 2,500 turbines worldwide.

External investors

In addition to the wind farms in wpd AG’s own pipeline, wpd windmanager is taking over more and more operational management projects from external investors. “Thanks to our size, our know-how and the different target markets we are an interesting partner for many companies operating internationally, for example to gain a foothold in new markets or to receive cross-national support for the entire portfolio”, explains Till Schorer, Director Sales at wpd windmanager. In the last two years alone, wpd windmanager was able to acquire around 225 MW via external projects – and counting.

Growing service portfolio

wpd windmanager has been offering all technical operational management and business management services for wind farms and increasingly also for solar parks since 1998. These include information management with central contact points for clients, a 24/7 control room, the in-house field service and experts that can deal with specialised questions regarding the plants. wpd windmanager is continuously expanding its service portfolio to provide clients with more individual support for their wind farms. Furthermore, wpd windmanager supports the continued development of wind energy and promotes new industry standards through cooperation in research and development.



wpd windmanager GmbH & Co. KG

Adress	Stephanitorsbollwerk 3 28217 Bremen
Phone	+49 (0)421 8976 600
E-Mail	windmanager@wpd.de
Web	www.windmanager.de
Category	Operation & Service
Profile	Technical & commercial operational management
Turnover	€ 12 million
Employees	400
Founding year	1998



Wind Industry Day in Bremen, Germany
Photo: Steffi Lõos

ASSOCIATIONS:

German Wind Energy Association | GWEC

BWE and GWEC are the voice of the national and international wind industry. The companies in the wind industry meet in the advisory boards of the BWE and he passes on technical knowledge to experts and newcomers alike.



The expert committees at the German Wind Energy Association (BWE)

Advisory boards – Forums – Working groups

At the BWE, operators, manufacturers, suppliers and service providers are organised into expert committees such as advisory boards, working groups and forums.



At the advisory board meetings, companies in the wind energy sector meet to discuss and resolve current issues and to develop long-term strategies concerning the most important issues in the industry.

Within their specialist areas, they therefore function as an important platform for exchange. The work carried out by these expert leads to position papers and statements; the standards developed then act as a guideline for the entire wind industry. The advisory boards are represented on the federal executive board of the BWE by four representatives, giving them a strong say in the association's policies.

Advisory board of operational managers

The advisory board of operational managers deals with all commercial and technical aspects related to wind turbine operation. Its members are also active in other associations to work towards guidelines.

Citizen's wind energy advisory board

The citizen's wind energy advisory board brings together operators of citizen's wind farms. Concerned with implementing the energy transition through citizen's and community-owned energy projects, it represents the interests of citizen's wind farm operators within the BWE.

Communication advisory board

Communication experts from the wind energy sector come together here to discuss how to communicate wind energy topics to the public in press and PR work. Member companies jointly plan campaigns, brochures and social media activities.

Expert advisory board

The expert advisory board discusses and develops policies and procedural guidelines for the technical examination of wind energy systems.

Finance advisory board

The finance advisory board is open to all banks and financing companies with activities in the wind energy industry. It acts as a forum for the exchange of ideas between different companies, such as the financial impacts of relevant legislation.



Legal advisory board

The legal advisory board comprises over 100 lawyers and in-house legal counsels who together discuss current legal questions relating to wind energy. This involves the exchange of valuable information on current court cases. The latest legal proceedings are also discussed by the legal advisory board. Written opinions are submitted jointly with the BWE's Expert Committees Division.

Manufacturer and supplier board

Through the companies represented in it, the committee brings together representatives of the German wind industry in the BWE. The Board works closely with the BWE on industry-related topics.

Operators' advisory board

On the six operator forums at the BWE, members exchange knowledge about each manufacturers' wind turbines. Operators of both individual and multiple wind turbines are organised in such forums. The speakers of the forums meet regularly to discuss their experiences in the operators' advisory board.

Planning advisory board

The planning advisory board is an important platform for the exchange of information by planning companies. Expert presentations accompany the discussion of major topics such as local and national planning laws, the future shape of the EEG, and European energy policy. Together with the Expert Committees Division, members support the positioning of the BWE regarding planning questions.

Scientific advisory board

As a forum for BWE members active in research and science, the scientific advisory board deepens current scientific discourses and establishes future research needs.

Wind consultant advisory board

The focus of the wind consultant advisory board is on improving onshore wind forecasts in Germany. Constant exchange of experiences and regular presentations on the topic are a foundation of its work, which particularly results in the definition of minimum standards for expert reports.

Working groups are established at short notice to deal with current issues and problems. They are organised across different boards, are able to act quickly, and can also hire external experts if necessary. Representatives from around 131 member companies are currently involved in working groups for networks, radar, obstruction lighting, nature conservation and wind energy, foundations, energy policy and continued operation.

All 2,200 operator companies who are members of the BWE are organised in the operators' advisory board via operator forums. Of the 1,100 manufacturers, suppliers and service providers who are members, 220 companies are members of the boards of the BWE. Each board meets between 2 and 4 times a year. The work of the boards is supported by the Expert Committees Division of the BWE both thematically and organisationally. Close collaboration results in information and background papers for BWE members, positions on bills, or BWE positions. For further information on the work of the boards and working groups and to view the lists of members, go to: www.wind-energie.de/verband/fachgremien.



The expert committees at the German Wind Energy Association (BWE)

Address	EUREF-Campus – Haus 16 10829 Berlin
Phone	+49 (0)30 212341-210
Fax	+49 (0)30 212341-410
E-Mail	info@wind-energie.de
Web	www.wind-energie.de
Category	Organisations & Public institutions
Profile	Associations
Founding year	1996

01 | Photo: BWE/Nicole Dresen

02 | Photo: Ina Hildebrandt

German Wind Energy Association (BWE) EVENTS

KNOWLEDGE ABOUT WIND – NETWORKING – QUALIFICATION

The German Wind Energy Association – a strong partner

With around 20,000 members it is the world’s largest association for renewable energies. The BWE has been campaigning for a sustainable and efficient expansion of wind energy in Germany for many years.

With its ambitious expansion targets, the wind energy sector is the main driver of the energy transition. Together with its members, the BWE is fully committed to continuing the success story of German wind energy and to ensuring that the vision of “100 percent electricity from renewable energy” in Germany becomes a reality soon.



01

The German Wind Energy Association – knowledge & networking

In addition to political work, knowledge & networking is a central impetus for the German Wind Energy Association. BWE has accompanied the economic and technical progress of the industry for many years with its education events and publications from which everyone, novice and expert alike, can obtain the latest facts about the growing wind industry.



02



03

- 01 | BWE (federal) State Chamber;
Photo: Silke Reents
- 02 | 3rd Central German Wind Industry Day;
Photo: Stefanie Loos
- 03 | BWE Enercon Forum;
Photo: Martin Ziemer / nordpool
- 04 | 2nd Central German Wind Industry Day;
Photo: Stefanie Loos



04.

BWE events

With around 8,000 participants across nearly 140 events per year the BWE is the market leader in education in the wind energy sector. A wide variety of formats enable experts and leading figures from the wind energy sector to stay abreast of current developments and expand their networks.

The “Wind Industry Days” (Windbranchentage) have become an established platform for dialogue and a forum for exchange with political circles in various federal states. With up to 800 participants they are the largest BWE events. Every year they host numerous politicians representing all levels.

At the conferences, practice days, information days and seminars selected experts pass on their practical knowledge, enabling participants to learn about the latest developments in their respective fields. Frequently, new business leads are also established there.

BWE WebAcademy

From 90-minute webinars to three-day web seminars, the BWE WebAcademy provides you with the very latest information and knowledge. As usual, you can ask our experts questions, but from the comfort of your home or office. More than 100 offers are available every year, allowing you to tap into a wide range of topics and stay abreast of developments surrounding the wind energy sector, PV and other renewables without much effort.

An overview of all events can be found here: www.bwe-seminare.de

BWE PolicyBriefing

Several times a year the BWE uses its video stream to inform its members on political developments in the wind energy sector. Questions arising within the sector are answered live, allowing legislative processes and challenges to be closely observed and assessed as they develop. The BWE PolicyBriefing is an interactive and transparent way of communicating with BWE members with huge reach.



German Wind Energy Association

German Wind Energy Association (BWE) Events

Address	EUREF-Campus – Haus 16 10829 Berlin
Phone	+49 (0)30 20164-222
Fax	+49 (0)30 212341-362
E-Mail	seminare@wind-energie.de
Web	www.bwe-seminare.de
Category	Organisations & Public institutions
Profile	Education & Training
Founding year	1996

German Wind Energy Association (BWE) CORPORATE PUBLISHING

From ONLINE to PRINT: expert knowledge for the sector, attractively delivered

Under the brand name Wind Industry in Germany, the BWE publishes various products for a specialist audience within the wind energy sector. With these products the BWE provides its readers with comprehensive information on current developments within the sector.

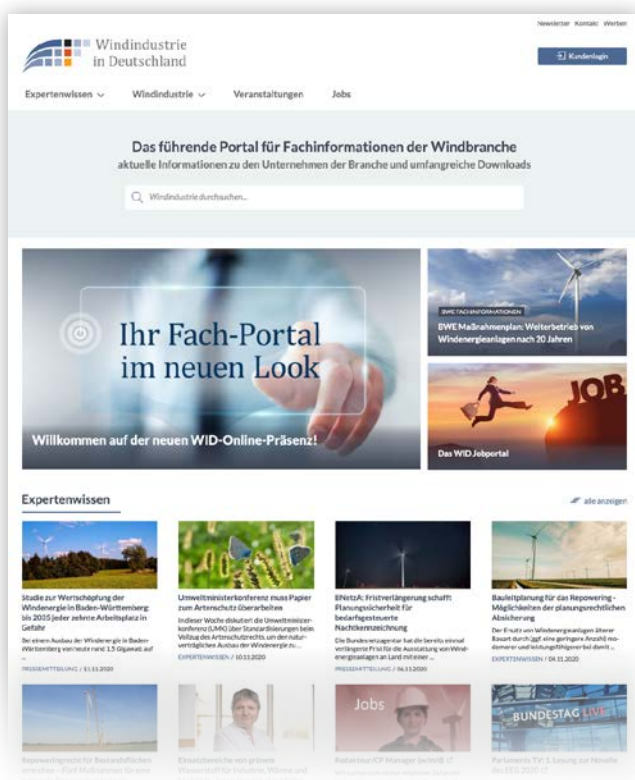

ONLINE FORMATS

windindustrie-in-deutschland.de

The website is the leading portal for specialist information within the wind energy sector. It offers current information on companies, a comprehensive collection of expert interviews and a broad range of further education and job opportunities, while the online company directory presents the who is who in the wind energy sector. In short: This site invites you to explore its content and to make the most of its information and educational opportunities!

Sector newsletter

The sector newsletter provides a weekly update of the most important news from the wind energy sector. Reaching about 12,000 recipients it is a press review that draws on the online presence of the sector.

Customised marketing options

The **Wind Industry in Germany** brand is a market leader when it comes to offering a wind energy sector-specific advertising platform for those engaged in marketing. Our range of marketing options includes:

- Online company listings
- Banners
- Newsletter announcements
- Stand-alone newsletters
- Company presentations
- Advertisements
- Event sponsoring
- And much more

Our well-established publications give you direct access to every **sector-relevant target group**. Contact us, we'll be happy to advise you!

Interested in realising your own corporate publishing project?

With our **long years of experience** as a publisher we'll gladly implement your own project in the field of renewable energies. We work with various service providers to realise your desired project quickly and according to your wishes. We look forward to hearing from you!



PRINT FORMATS

Wind Industry in Germany

The central aim of the present directory is to build connections within the German wind industry. It is the flagship of the wind energy sector where companies can present their services and products to a broad audience. The comprehensive address section makes it a real reference book for anyone looking for partners in the wind industry. The publication also presents innovative projects and start-ups.

BWE Wind Energy Yearbook

For the last 30 years the BWE has published the wind energy yearbook which offers an excellent overview of facts, figures and data and the development of both the market and technology in Germany, Europe and the world. The results of the BWE service survey and an overview of the German service market give insights into developments within this special segment of the industry.

BWE operators' newsletter

The operators' newsletter is a print format that is mailed to around 2,200 operators. It provides this important group with relevant information, covering current issues and forthcoming changes and offering tips for efficient operation.

BWE posters

The posters always reflect current issues, such as the development of wind power in Germany, repowering, continued operation, or nature conservation and species protection. The high print run of 20,000 to 30,000 ensures that the posters are widely distributed within the sector and beyond.



German Wind Energy Association (BWE) Corporate Publishing

Adress	EUREF-Campus – Haus 16 10829 Berlin
Phone	+49 (0)30 212341-164
Fax	+49 (0)30 212341-410
E-Mail	seminare@wind-energie.de
Web	www.bwe-seminare.de
Category	Other services
Profile	Media & Communication
Founding year	1996

Global Wind Energy Council

Unlocking markets for wind power around the world

Wind power is one of the critical pillars of the global energy transition. As wind power expands to new markets, the Global Wind Energy Council serves as the authoritative global voice to communicate wind power's benefits, policy recommendations and role in economic recovery.

The Global Wind Energy Council (GWEC) is a Belgium-based international trade association for the global wind power industry. Its mission is to ensure that wind power establishes itself as one of the key answers to today's energy challenges. GWEC works with governments in new and emerging wind markets in Latin America, Africa and Asia to communicate the benefits of wind power and support them in enacting their clean energy transitions.

GWEC's mandate comes from its expansive membership of leading wind developers and OEMs, as well as a network of wind and renewable energy associations active in more than 80 countries, including the world's largest wind markets of the US, Europe, India and China. Together, GWEC's membership includes more than 1,500 entities and represents 99% of the installed onshore wind power globally.

Advocacy & Policy

Our members work through dedicated task forces focused on regional and thematic policy issues, including: the Global Offshore Wind Task Force; the Floating Offshore Wind Task Force; the South East Asia Task Force; the Latin America Task Force; and the Africa Task Force.

GWEC also leads a global campaign to make wind power a cornerstone of green economy recovery packages, in response to the COVID-19 pandemic. In 2020, we released a statement endorsed by companies and associations representing 98 % of installed onshore wind power, outlining how investment in the wind sector can enable governments to renew critical infrastructure, deliver green jobs and provide clean and affordable power for a sustainable future.





Capacity-Building & Collaboration

GWEC works with the UNFCCC, IPCC, IRENA, IEA, REN21, RE100 and other institutions to advocate for wind power in a variety of international frameworks and initiatives. We support collaboration between policymakers in different markets to share best practices, address market and regulatory barriers and enhance commitments to clean energy.

Some examples of our work in 2020 include: partnering with the World Bank Group to organise the Offshore Wind Virtual Study Tour for international governments; launching the Offshore Wind Podcast; and organising a webcast series on Corporate Procurement of Renewable Energy in Emerging Markets with RE100.

This year, GWEC also co-authored a report on gender diversity in the global wind sector with IRENA as part of our Women in Wind Global Leadership Program, which aims to increase gender diversity and foster the next generation of industry leaders.

Market Intelligence

GWEC provides authoritative research and analysis on the global wind power industry through its Market Intelligence practice. Members have access to a database of detailed insights and reports, including a market data dashboard updated in real time and country profiles. Some of our work in 2020 includes the Global Wind Report, Global Offshore Wind Report, Supply Side Analysis Report, Powering the Future Report on workforces and the Africa Wind Energy Handbook.

Summits & Conferences

GWEC organises a series of dynamic events which convene policymakers, industry, civil society and other stakeholders to discuss opportunities and challenges of wind power. These events, including China Windpower, Brazil Windpower and Global Offshore Wind Summit Taiwan, also provide business environments for dialogue and matchmaking.

GWEC works at the highest international political level to create a better policy environment for wind power. Find out more about GWEC and its global community by visiting our website.



Global Wind Energy Council

Address	Rue Belliard 51-53 1000 Brussels
Phone	+32 (0)490 56 81 39
E-Mail	info@gwec.net
Web	https://gwec.net
Category	Organisations & Public institutions
Profile	Associations



A SG-8.0-167 DD offshore nacelle leaves the SGRE nacelle production plant in Cuxhaven, Germany.
Foto: Siemens Gamesa Renewable Energy/Ulrich Wirrwa

COMPANIES:

Industry directory

Around 350 addresses of leading companies in the wind industry.



Direct marketing

Direct marketers



BayWa r.e. Clean Energy Sourcing GmbH

Katharinenstr. 6, 04109 Leipzig

Tel.: +49 (0)341 30860600

Fax: +49 (0)341 30860606

E-Mail: clens@baywa-re.com

www.baywa-re.de

As a direct marketer, we provide plant operators with a comprehensive, transparent service. Our offer includes direct marketing as well as remuneration models for wind plants with expiring subsidy.



Centrica Energy Trading GmbH

Gustav-Mahler-Platz 1, 20354 20354 Hamburg

Tel.: +49 (0)40 228676-950

Fax: +49 (0)40 228676-958

E-Mail: energytrading@centrica.com

www.centricaenergytrading.com

Centrica Energy Trading is a leading European provider of energy management services. Our main competencies in Germany are Direct Marketing, Post EEG contracts, and PPAs for renewable assets.



GEWI GmbH

An der Börse 4, 30159 Hannover

Tel.: +49 (0)511 51949-290

E-Mail: info@gewi-ee.de

www.gewi.energy

INNOVATIVE, ECOLOGICAL, TOGETHER. GEWI GMBH

– YOUR PARTNER FOR DIRECT MARKETING

in.power Forecasting services providers



energy & meteo systems GmbH

Oskar-Homt-Str. 1, 26131 Oldenburg

Tel.: +49 (0)441 24921-0

Fax: +49 (0)441 249-479

E-Mail: mail@energymeteo.de

www.energymeteo.com

Digital services for the integration of renewable energies into grids and markets: wind and solar power forecasts, vertical grid load forecasts, transmission line monitoring, virtual power plant.



NATURSTROM AG

Parsevalstr. 11, 40468 Düsseldorf

Tel.: +49 (0)211 77900-380

Fax: +49 (0)211 77900-399

E-Mail: Direktvermarktung@Naturstrom.de

www.naturstrom.de

Benefit from attractive remuneration. We are your partner for electricity sales, have years of experience and are familiar with all the various marketing channels.



Statkraft Markets GmbH

Derendorfer Allee 2a, 40476 Düsseldorf

Tel.: +49 (0)211 60244-4404

E-Mail: direktvermarktung@statkraft.de

www.statkraftdirektvermarktung.de

Statkraft is a leading provider of market access services and a reliable partner with a pioneering spirit to promote the technical and economic integration of renewable energy.



Am Strom der Zukunft

VERBUND

Sonnenstr. 17, 80331 München

Tel.: +49 (0)89 89056 21933

Fax: +49 (0)89 89056 21950

E-Mail: direktvermarktung@verbund.de

www.verbund.de

VERBUND is one of the largest producers of electricity from hydropower in Europe. In Germany, we are your strong partner for reliable electricity procurement, direct marketing and energy solutions.

Education & training

Education & training



Akademie der Schraubverbindung (Barbarino & Kilp GmbH)

Justus-von-Liebig-Ring 17, 82152 Krailling/near Munich

Tel.: +49 (0)89 230999-0

E-Mail: info@akademie-sv.de

https://akademie-sv.de/

The Akademie der Schraubverbindung (AdSV®)

is your partner of choice for training and further education in bolting technologies. Internationally recognized certificates (ISO 29990).



blade care GmbH

Neuenfeld 41, 17291 Schoenefeld

Tel.: +49 (0)163 886 00 79

E-Mail: post@bladecare.de

www.bladecare.academy

blade care Academy is a DNG-GL certified training provider for administrators & rotor blade technicians & GWO Blade Repair course, with 25 years experience in rotor blade service by blade care GmbH.





Safety training

Deutsche Windtechnik Training Center Viöl

Mühlengrund 3, 25884 Viöl
 Tel.: +49 (0)4843 20448-163
 Fax: +49 (0)4843 20448-149
 E-Mail: y.daxenberger@deutsche-windtechnik.com
 www.deutsche-windtechnik.com
 The Training Center Viöl offers a practical training in original turbines of the leading manufacturers. Well-equipped training rooms offer optimal conditions for the theoretical knowledge transfer.



Deutsche WindGuard

An der Weinkaje 4/Klosterstr. 10,
 26931 Elsfleth/26506 Norden
 Tel.: +49 (0)4404 9875-100
 Fax: +49 (0)4451 9515-29
 E-Mail: buchung.training@windguard.de
 www.windguard-training.de
 Standardized Safety Trainings for the onshore and offshore wind industry. GWO basic safety trainings and refresher, Helicopter Underwater Escape Training as well as trainings according to DGUV.



Deutsche Windtechnik Training Center Bremen

Hüttenstr. 20a, 28237 Bremen
 Tel.: +49 (0)421 62677-10
 Fax: +49 (0)421 62677-11
 E-Mail: m.stueven@deutsche-windtechnik.com
 www.deutsche-windtechnik.com
 The Training Center provides certified safety courses in accordance with GWO & DGUV. All relevant safety aspects are rehearsed in a realistic environment with experienced trainers.



OffTEC Base GmbH & Co. KG

Lecker Str. 7, 25917 Enge-Sande
 Tel.: +49 (0)4662 89127-0
 Fax: +49 (0)4662 89127-88
 E-Mail: info@offtec.de
 www.offtec.de
 Certified provider GWO Basic Safety Training:
 Working at Heights, First Aid, Fire Awareness (all in line with DGUV), Manual Handling, Sea Survival, HUET, First Aid Offshore, Turbine Technology etc.



SHE Solution Bergmann GmbH & Co. KG

Im Sundernkamp 2, 32130 Enger
 Tel.: +49 (0)5224 9393850
 Fax: +49 (0)5224 9393852
 E-Mail: info@she-solution.de
 www.she-solution.de
 SHE is your training provider for safety trainings according to GWO and DGUV standards. The trainings are conducted realistically by experienced trainers, if desired also as in-house training.

Energy services

Construction, operation, direct marketing



EnBW Energie Baden-Württemberg AG

Schelmenwasenstr. 15, 70567 Stuttgart
 Tel.: +49 (0)711 289 0
 E-Mail: windkraft@enbw.com
 www.enbw.com/windkraft
 EnBW is one of the largest energy companies in Europe with 23,000 employees, and supplies electricity, gas, water, and services to around 5.5 million customers.



ENGIE Deutschland

Tempelhofer Weg, 10829 Berlin
 Tel.: +49 (0)30 915810-250
 Fax: +49 (0)30 915810-001
 E-Mail: alexa.schroeder@engie.com
 www.engie-deutschland.de
 ENGIE is all about „Zero Carbon“ and the transition to climate neutrality. In wind and photovoltaics, we are nr. 1 in France. We offer efficient energy solutions to companies and local authorities.



RWE Renewables GmbH

Kruppstr. 74, 45145 Essen
 Tel.: +49 (0)201 5179 5008
 Fax: +49 (0)201 5179 5005
 E-Mail: communications@rwe.com
 www.rwe.com
 RWE Renewables produces electricity from renewable energy sources. The company is a global player from Germany: number two worldwide in offshore wind power.



Manufacturer and supplier advisory board



Expert consulting advisory board



Investors' advisory board



Expert consulting advisory board



Scientific advisory board



Operators' advisory board

Energy services



Landstrom GmbH & Co. KG

Watenstedter Str. 11, 38384 Gevensleben

Tel.: +49 (0)5354 26600-66

Fax: +49 (0)5354 26600-19

E-Mail: info@landstrom-landwind.de

www.landstrom-landwind.de

Climate-neutral electricity and gas from a single source, direct marketing, service and consultancy across the entire spectrum of renewable energies in co-operation with Landwind at competitive prices.

Inspection bodies/ measurement institutes



WIND-certification GmbH

Reuterstr. 10, 18211 Bargeshagen

Tel.: +49 (0)38203 7483-10

Fax: +49 (0)38203 7483-11

E-Mail: info@wind-certification.de

www.wind-certification.de

Certification body: system certificates, unit certificates, component certificates

BWT Bavnick Wind-Technik GmbH

Bentheimer Str. 20, 48465 Schüttorf

Tel.: +49 (0)5923 71555

Fax: +49 (0)5923 71557

E-Mail: h.bavinck@bwt-wind.de

www.bwt-wind.de

Evaluation before commissioning, evaluation towards the end of the guarantee, expert evaluation of gears (endoscopic), regular checks, vibration analyses (CMS / on- or offline), expert damage assessment.



WindGuard Certification

Oldenburger Str. 65, 26316 Varel

Tel.: +49 (0)4451 9515-0

Fax: +49 (0)4451-9515-29

E-Mail: info@windguard-certification.de

www.windguard-certification.com

Certification body and test laboratory for testing & certification of electrical grid compliance (wind, solar, CHP), certification of WTG & continued operation, SDA & project certification.



DEKRA Automobil GmbH

– Industrie, Bau & Immobilien –

Handwerkstr. 15, 70565 Stuttgart

Tel.: +49 (0)800 333 333 3

E-Mail: kundencenter@dekra.com

www.dekra.de

Tests, assessments, measurements of wind energy plants on-/offshore, access platforms, pressure tanks, electrical engineering, continued operation expertises. Throughout Germany an independent partner

Certification



M.O.E. GmbH

Fraunhoferstr. 3, 25524 Itzehoe

Tel.: +49 (0)4821 6453-100

Fax: +49 (0)4821 6453-140

E-Mail: info@moe-service.com

www.moe-service.com

M.O.E. is an accredited test laboratory and certification and inspection body, which offers services to ensure the long-term and conformen operation of wind turbines.



8.2 | The Experts in
Renewable Energy

8.2 Group e. V.

Burchardstr. 17, 20095 Hamburg

Tel.: +49 (0)40 22864569

E-Mail: request@8p2.de

www.8p2.de

Technical consulting and inspections for on- and offshore wind projects, i.a. QA, manufacturing surveillance, HSE, grid integration, technical due diligences, expert opinions (e.g. RCA), design review.



Deutsche WindGuard

Oldenburger Str. 65, 26316 Varel

Tel.: +49 (0)4451 9515-0

Fax: +49 (0)4451 9515-29

E-Mail: info@windguard.de

www.windguard.com

Accredited inspection body (DIN EN ISO/IEC 17020), periodic, condition oriented and commissioning inspections, video endoscopy, manufacturing & installation supervision, damage analyses.



TÜV SÜD Industrie Service GmbH

Westendstr. 199, 80686 Munich

Tel.: +49 (0)89 5791-1232

Fax: +49 (0)89 5791-2022

E-Mail: windenergie@tuvsud.com

www.tuvsud.com/wind-power

Type certification, project certification, offshore certification, site assessment, operating time extension



airXite GmbH

Schlossstr. 33, 03205 Calau

Tel.: +49 (0)354 18879030

Fax: +49 (0)354 18879039

E-Mail: mail@airxite.com

www.airxite.com

electrical inspection incl. maintenance & repairs, low & medium voltage, transformer & switchgear exchange, rental transformer, grounding systems & seals, troubleshooting & suppression, multibrand

Deutsche Windtechnik Offshore und Consulting GmbH

Stephanitorsbollwerk 1 (Haus LEE), 28217 Bremen

Tel.: +49 (0)421 69105-0

Fax: +49 (0)421 69105-299

E-Mail: gutachten@deutsche-windtechnik.com

www.deutsche-windtechnik.com

Accredited inspection body for wind turbines in accordance with DIN EN ISO/IEC 17020:2012 Type C (D-IS-20474-01-00). Certified to ISO 9001, ISO 14001 and OHSAS 18001.



Wind assesment advisory board



Financing advisory board



Communication advisory board



Legal advisory board



Planning advisory board



energieprofile Ing.-büro GmbH & Co. KG
 Kotzenbruehl 4C, 87700 Memmingen
 Tel.: +49 (0)8331 983-686
 Fax: +49 (0)8331 983-465
 E-Mail: Stephan.Glocker@energieprofile.de
 www.energieprofile.de
 Publicly appointed and authorized expert for wind turbines, member of WINDexperts GmbH – commissioning inspections – periodical inspections, EOW – drivetrain inspections (videoendoscopy, CMS) – consulting



GfM Gesellschaft für Maschinendiagnose mbH
 Koepenicker Str. 325, 12555 Berlin
 Tel.: +49 (0)30 65762565
 Fax: +49 (0)30 65762564
 E-Mail: mailbox@maschinendiagnose.de
 www.maschinendiagnose.de
 Vibration Diagnosis | Inspection | Videoendoscopy
 | Blade Bearing Diagnosis | Foundation Monitoring
 | Torque Analysis



Ingenieurbüro Andresen
 Uthlander Str. 34, 25813 Husum
 Tel.: +49 (0)4841 7206-72
 Fax: +49 (0)4841 7206-73
 E-Mail: info@ibandresen.de
 www.ibandresen.de
 Officially appointed expert for wind turbines, technical inspections, commissioning and warranty inspections, recurring and condition-oriented inspections, lifetime extension, CMS, video endoscopy.



expert office Dipl.-Ing. Harald Eden
 An der Beverbäke 4b, 26123 Oldenburg
 Tel.: +49 (0)441 21823-10, +49 (0)170 55 13 877
 Fax: +49 (0)441 21823-11
 E-Mail: sv-eden@t-online.de
 www.sv-eden.de
 Publicly appt/sworn expert for causes of fire and electrical systems of energy technology. VdS electrotechnical expert. Investigation of fire damage, electrotechnical causes, fire prevention analysis.

HD-Technic GmbH
 Venesch 6a, 49477 Ibbenbüren
 Tel.: +49 (0)5451 3591
 Fax: +49 (0)5451 745540
 E-Mail: info@hd-technic.com
 www.hd-technic.com
 HD-Technic has been a competent and trusted partner in the energy sector for more than 25 years. As an engineering and expert office, we support and advise in all phases of a project.



Jadewind GmbH & Co. KG
 Lange Str. 6, 26316 Varel
 Tel.: +49 (0)4451 862228
 Fax: +49 (0)4451 862282
 E-Mail: info@jadewind.de
 www.jadewind.de
 Publicly appointed and sworn expert, Appraisal of WEC at – end of warranty – commissioning – periodic and condition based inspection – damage claim – court expert.



FAKON Wind GmbH
 Zum Nordkai 16, 26725 Emden
 Tel.: +49 (0)4921 8013308
 E-Mail: info@fakonwind.de
 www.fakonwind.de
 Interim Management, Project Management, Expert Reports, Due Diligence, Examination of Insurance Claims, SCADA, Grid Connection, Construction Supervision, Expert Services, Advice on O & M

IDASWIND GmbH
 Pintschstr. 3, 10249 Berlin
 Tel.: +49 (0)303 642887-70
 Fax: +49 (0)303 642887-77
 E-Mail: info@idaswind.com
 www.idaswind.de
 As an independent engineering office IDASWIND is active in the development, design & optimization of WTGs. Furthermore, the preparation of the LTE reports of WT 20+ is one of our core competences.



Jetstream Bosse Ing.-Büro für Windenergienutzung
 Hoepfnerstr. 34, 12101 Berlin
 Tel.: +49 (0)30 789915-25
 Fax: +49 (0)30 789915-26
 E-Mail: info@jetstream-bosse.de
 www.jetstream-bosse.de
 Expert opinions, inspections, remote data monitoring, technical advice, alignment inspection, video endoscopy, operational management WEC and wind farms, due diligence, valuation.



FGH
 Voltastr. 19-21, 68199 Mannheim
 Tel.: +49 (0)621 8047-100
 Fax: +49 (0)621 8047-113
 E-Mail: info@fgh-ma.de
 www.fgh-ma.de
 Full level support in terms of grid integration of renewable energy plants and associated components (according to international grid codes).



ie-Renewables | Ingenieurbüro für Erneuerbare Energien - Dr. Ingo Ewald
 Pilgersberg 1, 55276 Oppenheim
 Tel.: +49 (0)6133 938293-0
 E-Mail: info@ie-renewables.de
 www.ie-renewables.de
 Professional and comprehensive consultancy services: regional as well as international project development, Due Diligence, contract negotiation/tendering, Repowering, Asset Management & more.



KÖTTER Consulting Engineers GmbH & Co. KG
 Bonifatiusstr. 400, 48432 Rheine
 Tel.: +49 (0)5971 9710-31
 Fax: +49 (0)5971 9710-43
 E-Mail: oliver.bunk@koetter-consulting.com
 www.koetter-consulting.com
 Consulting, sound & shadow casting prognosis, immission and emission measurements for all WTG types and manufacturers. Expert opinions for approval procedure, construction acoustics, training courses.



Manufacturer and supplier advisory board



Expert consulting advisory board



Investors' advisory board



Expert consulting advisory board



Scientific advisory board



Operators' advisory board



plan-GIS GmbH

Sedanstr. 29, 30161 Hannover
 Tel.: +49 (0)511 33648-300
 Fax: +49 (0)511 33648-535
 E-Mail: info@plangis.de
 www.plangis.de
 planGIS prepares environmental reports (EIA, landscape planning, species conservation, visibility/visual impact analysis), immission control reports (noise/shadow) and restriction analyses.



Industrie Service

TÜV SÜD Industrie Service GmbH

Westendstr. 199, 80686 München
 Tel.: +49 (0)89 5791-1232
 Fax: +49 (0)89 5791-2022
 E-Mail: windenergie@tuvsud.com
 www.tuvsud.com/windenergy
 Periodic inspections, acceptance inspections, site assessment, operating life extension, type certification, project certification, offshore certification.



Wölfel Wind Systems GmbH

Max-Planck-Str. 15, 97204 Höchberg
 Tel.: +49 (0)931 49708-0
 Fax: +49 (0)931 49708-150
 E-Mail: info@woelfel.de
 www.woelfel.de
 From structural health monitoring including ice detection to dampers for tonalities and vibrations – we offer proven solutions to increase yield and optimize lifetime extension.



RolaWind GmbH

Schauenburger Str. 116, 24118 Kiel
 Tel.: +49 (0)1520 3089922
 Fax: +49 (0)431 53038243
 E-Mail: Wolfgang.Klein@rolawind.de
 www.rolawind.de
 Non-destructive material testing on wind energy + PV systems using our european wide patented technology + UAV. Thermographic evaluation + optical imaging VDE conform to DIN IEC / TS 62446-3



WIND-consult GmbH

Reuterstr. 9, 18211 Admannshagen-Bargeshagen
 Tel.: +49 (0)38203 507-25
 Fax: +49 (0)38203 507-23
 E-Mail: company@wind-consult.de
 www.wind-consult.de
 Inspections prior to Commissioning, for Acceptance and prior to Warranty expiry, Periodical Inspection, Extended Lifetime 20+, Checking Blade Angle, Main Grid Protection Test, Harmonics Measurement

Wind resource evaluators



AL-PRO GmbH & Co. KG

Dorfstr. 100, 26532 Grobheide
 Tel.: +49 (0)4936 69860
 E-Mail: info@al-pro.de
 www.al-pro.de
 AL-PRO is accredited for: LIDAR wind measurements (with own devices), wind data analyses (bankable), turbulence, shadow and noise assessments and weather and yield forecasts.



Rosendahl & Frank Windtechnik GmbH

Hermann-Scheer-Str. 1, 26736 Krummhörn
 Tel.: +49 (0)4923 805977-1
 Fax: +49 (0)4923 805977-2
 E-Mail: info@rfw-gmbh.de
 https://windkraft-gutachten.de/
 Recurring inspections | Rotor blade inspections with lightning protection measurement | Lifetime extension (BPW) | Commissioning and warranty inspections | Vibration analyses | Damage reports



windexperts Prüfgesellschaft mbH

Überseetor 14, 28217 Bremen
 Tel.: +49 (0)421 377 074 30
 Fax: +49 (0)421 377 074 77
 E-Mail: info@windexperts.de
 www.windexperts.de
 Network of experts for wind turbines - Appraisals: commissioning, periodical, condition oriented and end of warranty inspections, extended operation, CMS, video endoscopy, damage appraisals



anemos

Gesellschaft fuer Umweltmeteorologie mbH
 Boehmsholzer Weg 3, 21391 Reppenstedt
 Tel.: +49 (0)4131 8308-0
 Fax: +49 (0)4131 8308-199
 E-Mail: kontakt@anemos.de
 www.anemos.de
 anemos Gesellschaft für Umweltmeteorologie is an accredited independent consulting company for wind energy meteorology and your first-choice-partner for wind and energy studies in Germany and abroad.



TÜV Rheinland Industrie Service GmbH

Am Grauen Stein, 51105 Köln
 Tel.: +49 (0)221 8064536
 Fax: +49 (0)221 8061886
 E-Mail: wind@de.tuv.com
 www.tuv.com
 TÜV Rheinland provides technical inspection, testing and certification services for our onshore and offshore wind energy clients. Learn more about our services, get in contact with us!



windtest grevenbroich gmbh

Frimmersdorfer Str. 73a, 41517 Grevenbroich
 Tel.: +49 (0)2181 22780
 Fax: +49 (0)2181 227811
 E-Mail: info@windtest-nrw.de
 www.windtest-nrw.de
 Accredited services such as measurements of electrical characteristics, power performance/curve, loads, acoustics, site evaluations (site quality, yield report, shadow impact), LiDAR verification



Wind assesement advisory board



Financing advisory board



Communication advisory board



Legal advisory board



Planning advisory board



anemos-jacob GmbH

Oldershausener Hauptstr. 22, 21436 Oldershausen
Tel.: +49 (0)4133 210696
Fax: +49 (0)4133 210695
E-Mail: wind@anemos-jacob.com
www.anemos-jacob.com

Internationally recognised independent consultant for wind resource assessments, wind measurements, due diligence, site suitability, analysis and optimisation of wind farm and wind turbine performance.



Ingenieurbüro Kuntzsch GmbH

Moritzburger Weg 67, 01109 Dresden
Tel.: +49 (0)351 88507-1
Fax: +49 (0)351 88507-409
E-Mail: gutachten@ib-kuntzsch.de
www.windgutachten.de

DIN ISO 17025 accredited for wind measurements, energy yield assessments, site quality; noise & shadow-flicker assessment, visualizations, WINDebit operational data evaluation, wind energy yield index



PLANKon Ing.-Büro für Windenergieprojekte

Blumenstr. 26, 26121 Oldenburg
Tel.: +49 (0)441 39034-0
Fax: +49 (0)441 39034-22
E-Mail: mail@plankon.de
www.plankon.de

Expert opinions/consultancy for wind, noise, shadow; wind measurements, planning, accredited test laboratory acc. to DIN ISO 17025.



Deutsche WindGuard

Oldenburger Str. 65, 26316 Varel
Tel.: +49 (0)4451 9515-0
Fax: +49 (0)4451 9515-29
E-Mail: info@windguard.de
www.windguard.com

Wind measurements, wind resource & energy yield assessment, site suitability studies, noise/shadow prognosis, noise measurement, power curve measurement, load measurement, ice throw risk assessment.



menzio GmbH

Zum Nordkai 16, 26725 Emden
Tel.: +49 (0)4921 8018717
E-Mail: info@menzio.de
www.menzio.de

WindStation CFD, Sector Management, Monitoring of Overhead Lines, Wind and Energy Yield assessments, Assessments for BimSchG Approval, Offshore Assessments



Power of Nature – Windenergie

Aulendorf 40, 48727 Billerbeck
Tel.: +49 (0)2543 93046-74
Fax: +49 (0)2543 93046-73
E-Mail: joerg.fuertges@powernature.de
www.powernature.de

Wind/yield forecasts, noise immission prognoses, shadow flicker analyses, visual impact assessments, visualisation of wind projects, turbulence assessment, evaluation/analysis of wind data.

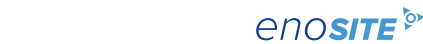

enosite GmbH

Straße am Zeltplatz 7, 18230 Ostseebad Rerik
Tel.: +49 (0)38296 7474-10
Fax: +49 (0)38296 7474-20
E-Mail: beate.mallow@eno-site.com
www.eno-site.com

Services ranging from expert opinions to approval procedures are part of our portfolio. Many years of experience and professional competence ensure a first-class manufacturer-independent support.



Meteorologisches Beratungsbüro, Dr. S. Theunert

Kolberger Str. 21, 54516 Wittlich
Tel.: +49 (0)6571 5912
Fax: +49 (0)6571 28849
E-Mail: theunert@metconsult-online.de
www.metconsult-online.de

Energy yield assessment, expertise on yield loss during planning and operation, noise assessment, evaluation of measurement data, data monitoring, expertise on individual issues.



Ramboll

Elisabeth-Consbruch-Str. 3, 34131 Kassel
Tel.: +49 (0)561 288573-0
E-Mail: info@ramboll.com
www.ramboll.com

Ramboll works according to national and international guidelines and standards to offer state-of-the-art wind analyses that comply with the current state of scientific knowledge.



GEO-NET Umweltconsulting GmbH

Grosse Pfahlstr. 5a, 30161 Hanover
Tel.: +49 (0)511 38872-00
Fax: +49 (0)511 38872-01
E-Mail: info@geo-net.de
www.geo-net.de

Reports of: Wind and energy yields (TR6), wind potential studies, LiDAR/ mast measurements /veri. MEASNET, micrositing, optimisation of wind farm layout, techn. due diligence and turbulence expertise



Pavana GmbH

Otto-Hahn-Str. 12–16, 25813 Husum
Tel.: +49 (0)4841 8944-227
E-Mail: info@pavana-wind.com
www.pavana-wind.com

Pavana GmbH is an accredited company (acc. DIN EN ISO/IEC 17025) for energy yield reports, noise studies, flicker studies, wind measurement campaigns and LiDAR verification.



reko Windenergie-Analysen

Sander-Bruch-Str. 10, 33106 Paderborn
Tel.: +49 (0)5254 9528129
Fax: +49 (0)5254 952729
E-Mail: r.korfmacher@rekowind.de

Noise immission prognoses, shadow flicker analyses, wind/yield forecasts for sites, visualisation, visual inspection by drone.



Manufacturer and supplier advisory board



Expert consulting advisory board



Investors' advisory board



Expert consulting advisory board



Scientific advisory board



Operators' advisory board



Tractebel Engineering GmbH

Friedberger Str. 173, 61118 Bad Vilbel
 Tel.: +49 (0)6101 55-1445
 Fax: +49 (0)6101 55-1826
 E-Mail: info-de@tractebel.engie.com
 www.tractebel-engie.com/en/solutions/energy#renewables

Tractebel Engineering GmbH offers world-wide planning and consulting services for onshore and offshore wind farm projects as well as wind expertises according to ISO 17025.

Finance & law

Banks, financial institutions & financial service providers



DAL Deutsche Anlagen-Leasing GmbH & Co. KG

Emy-Roeder-Str. 2, 55129 Mainz
 Tel.: +49 (0)6131 804-2201
 Fax: +49 (0)6131 804-72201
 E-Mail: info@dal.de
 www.dal.de

DAL is part of the German Savings Banks Finance Group and supports investments in the wind power sector with tailor-made financing solutions in Germany, France and the Netherlands.



DZ BANK AG

Platz der Republik, 60265 Frankfurt
 Tel.: +49 (0)40 35900-496
 Fax: +49 (0)40 35900-351
 E-Mail: alexandra.pohl@dzbank.de
 www.dzbank.com

DZ BANK's regional renewable energy teams make available their in-depth expertise for the assessment, structuring and financing of onshore wind energy projects.

Energy Invest Consulting AG

Energy Invest Consulting AG

Sihlstr. 95, CH-8001 Zürich
 Tel.: +41 (0)44 3901747
 Fax: +41 (0)44 3901749
 E-Mail: hoffmann@energyinvest.ch
 www.energyinvest.ch

Energy Invest Consulting AG has been an independent adviser since 2007 for investments in renewable energy with focus on wind (onshore and offshore) and solar energy in Germany, the EU and Norway.



Hamburg Commercial Bank AG

Gerhart-Hauptmann-Platz 50, 20095 Hamburg
 Tel.: +49 (0)40 3333-0
 Fax: +49 (0)40 3333-34001
 E-Mail: nils.driemeyer@hcob-bank.com
 www.hcob-bank.de

Hamburg Commercial Bank is one of the leading European experts for project financing in the field of renewables. We offer comprehensive know-how and are a reliable long-term partner.



Investitionsbank Schleswig-Holstein (IB.SH)

Fleethörn 29–31, 24103 Kiel
 Tel.: +49 (0)431 9905-0
 Fax: +49 (0)431 9905-3383
 E-Mail: info@ib-sh.de
 www.ib-sh.de

As a central state development institution IB.SH supports sustainable growth, progress and ongoing good living conditions in Schleswig-Holstein. For this it also supports wind energy.



Landwirtschaftliche Rentenbank

Theodor-Heuss-Allee 80, 60486 Frankfurt am Main
 Tel.: +49 (0)69 2107-700
 Fax: +49 (0)69 2107-6459
 E-Mail: office@rentenbank.de
 www.rentenbank.de

Rentenbank, Germany's development bank for agriculture and rural areas, offers low-interest financing for the generation, storage and distribution of renewable energies, among other things.



NORD/LB

Friedrichswall 10, 30159 Hannover
 Tel.: +49 (0)441 237-1667
 E-Mail: gerrit.schmidt@nordlb.de
 www.nordlb.de

Our bank has been involved in financing renewable energy projects since the mid-1990s. With numerous project financing and advisory mandates for wind farms we are one of the top arrangers.



TÜV NORD EnSys GmbH & Co. KG

Große Bahnstr. 31, 22525 Hamburg
 Tel.: +49 (0)40 8557 0
 Fax: +49 (0)40 8557 2552
 E-Mail: windenergy@tuev-nord.de
 www.tuev-nord.de

TÜV NORD certifies on- and offshore wind turbines to all international standards and regulations, evaluates specific site conditions and supports operation of wind turbines over their entire lifecycle



TÜV SÜD Industrie Service GmbH

Ludwig-Eckert-Str. 8, 93049 Regensburg
 Tel.: +49 (0)941 460212-0
 Fax: +49 (0)941 460212-29
 E-Mail: windenergie@tuvsud.com
 www.tuvsud.com/wind-power

Site assessment. Wind measurement – Mast – LIDAR – SODAR. Ice-throw risk analysis. Due diligence. Power performance test. Mechanical load measurement. Approval inspections. Periodic inspections.



WIND-consult GmbH

Reuterstr. 9, 18211 Admannshagen-Bargeshagen
 Tel.: +49 (0)38203 507-25
 Fax: +49 (0)38203 507-23
 E-Mail: company@wind-consult.de
 www.wind-consult.de

DAkS Accreditation / FGW / BWE, Measure & Expert's Reports for Planning & Permission of WT – Wind Measurements (Cup / LIDAR), Wind & Energy Yield, Turbulence & Stability, Extreme Wind, Site Quality



Wind assessment advisory board



Financing advisory board



Communication advisory board



Legal advisory board



Planning advisory board



reconcept. Green Global Investments

ABC-Straße 45, 20354 Hamburg
Tel.: +49 (0)40 3252165-0
Fax: +49 (0)40 3252165-69
E-Mail: info@reconcept.de
www.reconcept.de

reconcept is one of Germany's pioneers investing in renewable energy. Looking back at more than 20 years of investment experience, reconcept provides access to high-quality investment opportunities.

Deutsche WindGuard

Oldenburger Str. 65, 26316 Varel
Tel.: +49 (0)4451 9515-0
Fax: +49 (0)4451 9515-29
E-Mail: info@windguard.de
www.windguard.com

Due diligence, tender and contract consulting, wind turbine type and manufacturer assessment, analysis of operational wind farms, policy consulting & studies, market analysis.

Tractebel Engineering GmbH

Friedberger Str. 173, 61118 Bad Vilbel
Tel.: +49 (0)6101 55-1445
Fax: +49 (0)6101 55-1826
E-Mail: info-de@tractebel.engie.com
www.tractebel-engie.com/en/solutions/energy#renewables

Tractebel Engineering GmbH offers world-wide planning and consulting services for onshore and offshore wind farm projects as well as wind expertises according to ISO 17025.

Consulting & business consulting



BET Büro für Energiewirtschaft und technische Planung GmbH

Alfonsstr. 44, 52070 Aachen
Tel.: +49 (0)241 47062-400
Fax: +49 (0)241 47062-600
E-Mail: info@bet-aachen.de
www.bet-aachen.de

B E T supports players along the entire value chain, including developments in electricity prices and market values, tenders, procurement and marketing concepts, PPAs and grid integration.

EcofinConcept GmbH Renewable Energies

Rheinstr. 7, 41836 Hückelhoven
Tel.: +49 (0)2433 970-471
Fax: +49 (0)2433 970-107
E-Mail: info@ecofinconcept.de
www.ecofinconcept.de

Project development, acquisitions, project management, consultancy, procurement, financial concepts, private placements, transaction management, investments, wind and solar farms, repowering, EEG20+

Sterr-Kölln & Partner mbB

Emmy-Noether-Str. 2, 79110 Freiburg
Tel.: +49 (0)761 490540
Fax: +49 (0)761 493468
E-Mail: info@sterr-koelln.com
www.sterr-koelln.com

Sterr-Kölln & Partner has been one of the leading consulting companies in the wind industry for 25 years with a team of lawyers, tax consultants, auditors, and management consultants.



BOEHM-BEZING & CIE.

Boehm-Bezing & Cie. GmbH

Staffenbergstr. 44, 70184 Stuttgart
Tel.: +49 (0)711 722082-0
Fax: +49 (0)711 722082-99
E-Mail: boehm-bezing@bbcie.de
www.bbcie.de/index_en.html

Since 1999, Boehm-Bezing & Cie. has been one of the leading independent advisory firms in Germany for Corporate Finance and M&A, with special expertise in renewable energy and infrastructure.

enervis energy advisors GmbH

Schlesische Str. 29-30, 10997 Berlin
Tel.: +49 (0)30 695175-0
Fax: +49 (0)30 695175-20
E-Mail: kontakt@enervis.de
www.enervis.de

Business development for renewables: PPA-assessment, direct marketing, market value & revenue reports, auction model, market analyses for RES auctions, audit, wind project assessment, due diligence

Wind Multiplikator GmbH

Konsul-Smidt-Str. 76, 28217 Bremen
Tel.: +49 (0)421 83063969
E-Mail: info@windmultiplikator.de
www.windmultiplikator.de

Wind Multiplikator GmbH is an expert in the offshore wind energy sector specialized in the management of offshore wind projects as well as in the provision of consulting and engineering services.



Wind Multiplikator QHSE GmbH

Konsul-Smidt-Str. 76, 28217 Bremen
Tel.: +49 (0)421 83063969
E-Mail: info@windmultiplikator.de
www.windmultiplikator.de

Wind Multiplikator QHSE GmbH attends in the sector of offshore wind energy to all quality issues and handles projects dealing with occupational, health, and environmental safety.



Manufacturer and supplier advisory board



Expert consulting advisory board



Investors' advisory board



Expert consulting advisory board



Scientific advisory board



Operators' advisory board

Fund providers



Commerz Real

Kapitalverwaltungsgesellschaft mbH

Mercedesstr. 6, 40470 Düsseldorf

Tel.: +49 (0)211 7708-0

Fax: +49 (0)211 7708-3156

E-Mail: institutional@commerzreal.com

www.institutional.commerzreal.com

Commerz Real KVG manages structured real assets' investments in real estate (micro apartment complexes, hotels), renewable energies and infrastructure for (semi-) professional investors.

Insurance companies



Basler Sachversicherungs AG

Basler Str. 4, 61352 Bad Homburg v.d.H.

Tel.: +49 (0)6172 125 4600

Fax: +49 (0)6172 125 456

E-Mail: info@basler.de

www.basler.de

We have been supporting our customers in the field of renewable energies since the 1990s and are a reliable partner at your side.



Contrust Versicherungsmakler GmbH

An der Steinernen Brücke 1, 85757 Karlsfeld

Tel.: +49 (0)8131 5939060

Fax: +49 (0)8131 5939080

E-Mail: soenke.butz@contrust.com

www.contrust.com

Individual solutions for manufacturers, operators and project planners – worldwide!



Enser Versicherungskontor GmbH

An der Tigge 4, 59469 Ense

Tel.: +49 (0)2938 9780-0

Fax: +49 (0)2938 9780-30

E-Mail: info@evk-oberense.de

www.evk-oberense.de

One of the leading brokers in the renewable energy market, Serving over 10.000 clients world-wide, utilising the expertise as an operator, own concepts of insurance cover and own claim engineers.



Nordwest Assekuranzmakler GmbH & Co. KG

Herrlichkeit 5–6, 28199 Bremen

Tel.: +49 (0)421 989607 0

Fax: +49 (0)421 989607 209

E-Mail: info@nw-assekuranz.de

www.nw-assekuranz.de

We have been involved from the start with ground-breaking insurance products. We know the requirements of the market participants and develop coverage concepts based on the needs of your company.



R+V Allgemeine Versicherung AG

Raiffeisenplatz 1, 65189 Wiesbaden

Tel.: +49 (0)611 53398751

E-Mail: AgrarKompetenzCenter@ruv.de

www.ruv.de/firmenkunden/erneuerbare-energien/windenergie

R+V is one of the largest German insurance companies with over 8 million customers and 18 bn euros premium income. Our efficient service and collaborative approach set us apart from competitors.

Lawyers



Becker Büttner Held

Magazinstr. 15–16, 10179 Berlin

Tel.: +49 (0)30 6112840-0

Fax: +49 (0)30 6112840-99

E-Mail: bbh@bbh-online.de

www.die-bbh-gruppe.de/en/

BBH advises the energy sector with particular focus on renewable energies. We counsel on project planning, grids, feed-in management, remuneration, and direct marketing.



Bergmann Attorneys at Law

Pohjoisesplanadi 35 E, FIN-00100 Helsinki

Tel.: +358 (0)10 339 8800

E-Mail: claudia.greiner@bergmann.fi

www.bergmann.fi

Specialist legal advice for the Finnish wind sector.

Project development, M&A, financing and day-to-day business.



Blanke Meier Evers

Rechtsanwälte in Partnerschaft mbB

Stephanitorsbollwerk 1 (Haus LEE), 28217 Bremen

Tel.: +49 (0)421 94946-0

Fax: +49 (0)421 94946-66

E-Mail: info@bme-law.de

www.bme-law.de/home.html

Legal services in connection with renewable energy projects. This specifically concerns energy law, project finance, corporate finance, company law, tax law, contract law and public law.



Blanke Meier Evers

Rechtsanwälte in Partnerschaft mbB

Große Johannisstr. 9, 20457 Hamburg

Tel.: +49 (0)40 4321876-0

Fax: +49 (0)40 4321876-11

E-Mail: info@bme-law.de

www.bme-law.de/home.html

Legal services in connection with renewable energy projects. This specifically concerns energy law, project finance, corporate finance, company law, tax law, contract law and public law.



**DR. NIEDERSBERG**
RECHTSANWALT**Dr. jur. Jörg Niedersberg**

Hafenhaus-Bollhoernkai 1, 24103 Kiel

Tel.: +49 (0)431 98389-22

Fax: +49 (0)431 98389-66

E-Mail: kanzlei@anwalt-energie.dewww.anwalt-energie.de

Specialist in administrative law, contract law, environmental law, energy industry law, energy cartel law.

**ENGEMANN & PARTNER**
Rechtsanwälte und Notare**Engemann und Partner, Rechtsanwälte mbB**

Kastanienweg 9, 59555 Lippstadt

Tel.: +49 (0)2941 9700-0

Fax: +49 (0)2941 9700-50

E-Mail: a.lahme@engemann-und-partner.dewww.engemann-und-partner.de

Competencies and experiences in the field of renewable energies, administrative law, environmental law, building law, energy law, public liability law, contract law.

**MENOLD
BEZLER****Menold Bezler Rechtsanwälte Steuerberater****Wirtschaftsprüfer Partnerschaft mbB**

Stresemannstr. 79, 70191 Stuttgart

Tel.: +49 (0)711 86040-710

Fax: +49 (0)711 86040-203

E-Mail: verena.roesner@menoldbezler.dewww.menoldbezler.de

We bring together competencies in company, energy, contract, environmental, building and planning law to help you maximise wind energy opportunities whilst minimising risks.

**Osborne
Clarke****Osborne Clarke Rechtsanwälte Steuerberater
Partnerschaft mbB**

Innere Kanalstr. 15, 50823 Cologne

Tel.: +49 (0)221 51084530

Fax: +49 (0)221 51084531

E-Mail: daniel.breuer@osborneclarke.comwww.osborneclarke.com

Legal assistance for German and international projects and joint ventures throughout the renewable energy sector and comprehensive legal advice for companies and associations in the energy sector.

SATELL
RECHTSANWÄLTE
STEUERBERATER**SATELL Rechtsanwälte Steuerberater Reppich****PartmbB**

Nymphenburger Str. 4, 80335 München

Tel.: +49 (0)89 558903-0

Fax: +49 (0)89 558903-399

E-Mail: info@satell.dewww.satell.de

SATELL is a medium-sized law firm specialising in renewable energies. We provide advice on all legal issues relating to on-and offshore wind power as well as solar and geothermal energy technologies.

TaylorWessing**Taylor Wessing**

Hanseatic Trade Center,

Am Sandtorkai 41, 20457 Hamburg

Tel.: +49 (0)40 368030

E-Mail: c.bartholl@taylorwessing.comwww.taylorwessing.com

Taylor Wessing is a leading international law firm. The wind energy sector is a major focus of our services. We advise on project investment, project development as well as on financing issues.

WKL RECHTSANWÄLTE**WKL Rechtsanwälte (Witter & Kollegen Legal
Partnerschaft von Rechtsanwälten mbB)**

Neuer Wall 43, 20354 Hamburg

Tel.: +49 (0)40 210911-050

Fax: +49 (0)40 210911-055

E-Mail: info@wkl.legalwww.wkl.legal

As specialists for energy, real estate and infrastructure we have advised investors, banks and project developers on more than 150 domestic and international photovoltaic, wind and biogas projects.

Tax accountants**BDO****BDO Oldenburg GmbH & Co. KG****Wirtschaftsprüfungsgesellschaft**

Moslestr. 3, 26122 Oldenburg

Tel.: +49 (0)441 98050-0

Fax: +49 (0)441 98050-180

E-Mail: erneuerbare@bdo-oldenburg.dewww.bdo-oldenburg.de

Our company has been focusing on consultancy in the wind energy and renewable energies sectors for many years.

**Wind turbines (> 100 kW)****ENERCON**
ENERGY FOR THE WORLD**ENERCON GmbH**

Dreekamp 5, 26605 Aurich

Tel.: +49 (0)4941 927-0

Fax: +49 (0)4941 927-109

E-Mail: info@enercon.dewww.enercon.de/en

ENERCON products are known for their innovative technology, outstanding reliability and excellent returns on investment, worldwide.

**ENO ENERGY**
Success with wind.**eno energy Gruppe**

Am Strande 2e, 18055 Rostock

Tel.: +49 (0)381 203792-0

Fax: +49 (0)381 203792-101

E-Mail: info@eno-energy.comwww.eno-energy.com

The name eno energy has stood for the highest quality in innovative plant technology for international wind farm projects since 1999.



Manufacturer and supplier advisory board



Expert consulting advisory board



Investors' advisory board



Expert consulting advisory board



Scientific advisory board



Operators' advisory board



GE Renewable Energy

Holsterfeld 16, 48499 Salzbergen
 Tel.: +49 (0)5971 980-0
 Fax: +49 (0)5971 980-1999
 E-Mail: info_renewable.energy@ge.com
 www.gerenewableenergy.com
 Portfolio: Wind turbines from 1.6 to 5.5 MW.
 Support of project development, operation/
 maintenance, solutions for grid integration and
 commercial use of wind turbines.

Operation & service

Quality assurance



GOM – Gesellschaft für optische Messtechnik GmbH

Schmitzstr. 2, 38122 Braunschweig
 Tel.: +49 (0)531 39029-0
 Fax: +49 (0)531 39029-15
 E-Mail: info@gom.com
 www.gom.com
 GOM specializes in industrial 3D coordinate measuring technology, 3D computed tomography as well as 3D testing. GOM provides systems for manual and automated 3D digitization and evaluation software.

airXite GmbH

Schlossstr. 33, 03205 Calau
 Tel.: +49 (0)354 18879030
 Fax: +49 (0)354 18879039
 E-Mail: mail@airxite.com
 www.airxite.com
 electrical inspection incl. maintenance & repairs, low & medium voltage, transformer & switchgear exchange, rental transformer, grounding systems & seals, troubleshooting & suppression, multibrand



Nordex Group

Langenhorner Chaussee 600, 22419 Hamburg
 Tel.: +49 (0)40 30030-1000
 Fax: +49 (0)40 30030-1100
 E-Mail: info@nordex-online.com
 www.nordex-online.com
 The Nordex group offers powerful wind turbines for nearly all geographical regions across the globe.



BIL eG

Josef-Wirmer-Str. 1–3, 53123 Bonn
 Tel.: +49 (0)228 92585290
 E-Mail: info@bil-leitungsauskunft.de
 www.bil-leitungsauskunft.de
 BIL – The nationwide information system for power line enquiries offers twice the benefit for the wind energy sector.



Siemens Gamesa Renewable Energy GmbH & Co. KG

Beim Strohhaus 25, 20097 Hamburg
 Tel.: +49 (0)40 2889-8082
 E-Mail: Deutschland@siemensgamesa.com
 www.siemensgamesa.com
 Siemens Gamesa Renewable Energy offers onshore and offshore products as well as leading maintenance and repair services for making renewable energy affordable and reliable.

Service, maintenance & repair



ABO Wind AG

Oberdorfstr. 10, 55262 Ingelheim
 Tel.: +49 (0)6132 8988-00
 Fax: +49 (0)6132 8988-29
 E-Mail: vertrieb@abo-wind.de
 www.abo-wind.com
 Partial and full maintenance, replacement of large components, electrical testing, repairs: The decentralised ABO Wind Service maintains, tests, inspects and repairs wind turbines across Europe.

blade care GmbH

Neuenfeld 41, 17291 Schoenfeld
 Tel.: +49 (0)163 8860079
 E-Mail: post@bladecare.de
 www.bladecare-windenergy.com
 blade care GmbH provides rotor blades service for 25 years. blade care Academy is a DNV-GL certified education provider for Administrators & Technicians & provides GWO Blade Repair training



VENSYS Energy AG

Im Langental 6, 66539 Neunkirchen
 Tel.: +49 (0)6821 9517-0
 Fax: +49 (0)6821 9517-411
 E-Mail: vertrieb@vensys.de
 www.vensys.de
 VENSYS offers gearless wind turbines for all wind classes and locations.



BRAUER Maschinentechnik AG

Raffeisenring 25, 46395 Bocholt
 Tel.: +49 (0)2871 7033
 Fax: +49 (0)2871 7036
 E-Mail: j.brauer@brauer-getriebe.de
 www.brauer-getriebe.de
 Repair and improvement of wind turbine gearboxes of all types and in every size.



AeroBalancer – Meßsysteme Bergelt

Kötzschenbroder Str. 9, 01139 Dresden
 Tel.: +49 (0)351 41880849
 Fax: +49 (0)351 41880849-9
 E-Mail: info@aerobalancer.de
 www.aerobalancer.de
 Measurement of mass & aerodynamic imbalances, balancing of WTG rotors, blade angle measurements, equipment rental. Performance analysis, yield optimisation, fine adjustment of absolute blade angles.



Wind assessment advisory board



Financing advisory board



Communication advisory board



Legal advisory board



Planning advisory board



Buss Energy Group GmbH

Am Sandtorkai 48, 20457 Hamburg
Tel.: +49 (0)40 3198-0
Fax: +49 (0)40 3198-2000
E-Mail: buss-energy@buss-group.com
www.buss-energy.com

On-/Offshore: installation, service, maintenance of wind energy turbines and rotor blades. Base port logistics with project management, use of drones and all-weather platforms in rotor blade service.



Deutsche Windtechnik Offshore und Consulting GmbH

Stephanitorsbollwerk 1 (Haus LEE), 28217 Bremen
Tel.: +49 (0)421 69105-0
Fax: +49 (0)421 69105-299
E-Mail: info-dwtoc@deutsche-windtechnik.com
www.deutsche-windtechnik.com

Deutsche Windtechnik Offshore und Consulting provides maintenance for complete offshore windfarms and substations. Full-Service above as well as under water.



EMIS Electrics GmbH

Neckarsulmer Str. 3–5, 03222 Lübbenau/Spreewald
Tel.: +49 (0)3542 887575-30
Fax: +49 (0)3542 887575-88
E-Mail: info@emis-gruppe.de
www.emis-gruppe.de

SERVICE | INSPECTION | REPAIR | MAINTENANCED
GUV V3 tests, generator checks, switching operations, cable fault detection, cable route and power connection revisions, support of substations.



Connected Wind Services Deutschland GmbH

Mühlenberg 19, 25873 Rantrum
Tel.: +49 (0)4848 90128-0
Fax: +49 (0)4848 90128-22
E-Mail: info.de@connectedwind.com
www.connectedwind.com

Connected Wind Services: Whether it's maintenance, complex service projects, up-tower repairs or spare parts, Connected Wind Services is your independent, global service partner.



Deutsche Windtechnik Service GmbH & Co. KG

Osterport 2e, 25872 Ostenfeld
Tel.: +49 (0)4845 79168-0
Fax: +49 (0)4845 79168-29
E-Mail: info-dwts@deutsche-windtechnik.com
www.deutsche-windtechnik.com

Full and basic maintenance with focus on Vestas/NEG-Micon, Siemens/AN Bonus, Gamesa, Enercon; component exchange; repairs; upgrades; replacement parts; monitoring; optimization; consultancy.



EnBW Energie Baden-Württemberg AG

Schelmenwasenstr. 15, 70567 Stuttgart
Tel.: +49 (0)711 289-89844
Fax: +49 (0)711 289-87264
E-Mail: betriebsfuehrung-wind@enbw.com
www.enbw.com/windonshore-betrieb

Manufacturer-independent but with at least the same level of quality, quick availability, efficiency and fast response times.



cp.max Rotortechnik GmbH & Co. KG

Manfred-von-Ardenne-Ring 5, 01099 Dresden
Tel.: +49 (0)351 858934-50
Fax: +49 (0)351 858934-577
E-Mail: info@cpmax.com
www.cpmax.com

cp.max Rotortechnik offers you the complete service for a long life of your rotor blades and an optimal yield of your turbine.



Deutsche Windtechnik X-Service GmbH

Heideweg 2–4, 49086 Osnabrück
Tel.: +49 (0)541 380538-100
Fax: +49 (0)541 380538-199
E-Mail: info-dwtx@deutsche-windtechnik.com
www.deutsche-windtechnik.com

Full and basic maintenance with focus on Nordex, Servion and Fuhrländer; repairs; exchange of large components; upgrades/optimization; replacement parts; monitoring; consultancy.



ENERTRAG Service GmbH

Gut Dauerthal, 17291 Dauerthal
Tel.: +49 (0)39854 6459-0
Fax: +49 (0)5404 9170-492
E-Mail: service@enertrag.com
www.enertrag.com

The ENERTRAG service team ensures the commercial success of your wind turbine. We take on servicing, inspection, preventive maintenance, repair and the exchange of large components.



Deutsche Windtechnik AG

Stephanitorsbollwerk 1 (Haus LEE), 28217 Bremen
Tel.: +49 (0)421 69105-0
Fax: +49 (0)421 69105-499
E-Mail: info@deutsche-windtechnik.com
www.deutsche-windtechnik.com

Independent full scope O&M provider for multibrand wind turbine technologies, onshore and offshore: Full and basic maintenance, repairs, expert reports, QHSE, management services, repowering and more



ELPRESS GmbH

Kränkelsweg 24, 41748 Viersen
Tel.: +49 (0)2162 93190
Fax: +49 (0)2162 350403
E-Mail: info@elpress.de
www.elpress.de

Global manufacturer of electromechanical connection technology.



FLYTEG GmbH & Co. KG

Carl-Zeiss-Str. 13, 24568 Kaltenkirchen
Tel.: +49 (0)4191 9912794
Fax: +49 (0)4191 9912794
E-Mail: office@flyteg.com
www.flyteg.com

FLYTEG GmbH & Co. KG specializes in busbar repair and busbar control in wind turbines. We also offer corrosion protection work using rope technology or with our own working platform.



Manufacturer and supplier advisory board



Expert consulting advisory board



Investors' advisory board



Expert consulting advisory board



Scientific advisory board



Operators' advisory board



Framatome GmbH

Paul-Gossen-Str. 100, 91052 Erlangen
 Tel.: +49 (0)9131 900-31548
 Fax: +49 (0)9131 900-851258
 E-Mail: wind@framatome.com
www.framatome.com/solutions-portfolio/pages/offer.aspx?bid=5
 M&D technologies for vibrations; Flat UT probes; NDT services; Phased-Array NDT; Root Cause Analyses; Fitness-for-Service Assessments; complex FE calculations. Also supporting extended operation.



Koopmann Gruppe

Zum Brook 19-21, 49661 Cloppenburg
 Tel.: +49 (0)4471 9494-0
 Fax: +49 (0)4471 84895
 E-Mail: info@hk-c.de
www.hk-c.de
 As one of the leading service providers for energy and electrical engineering, we ensure the safe and trouble-free operation of our customers' systems.



Polygonvatro GmbH - Windkraft Service -

Glück-Auf-Weg 9, 57482 Wenden
 Tel.: +49 (0)800 8408508
 E-Mail: service@polygonvatro.de
www.polygonvatro.de
 POLYGONVATRO offers a range of services within the areas of property damage restoration after fire, water & climate events. For WT we offer renovation services & 3D blade tests. ALWAYS BY YOUR SIDE



GAIA mbH

Jahnstr. 28, 67245 Lamsheim
 Tel.: +49 (0)6233 35944-00
 Fax: +49 (0)6233 35944-01
 E-Mail: info@gaia-mbh.de
www.gaia-mbh.de
 Your professional partner for planning, development, project coordination and storage solutions; servicing and technical management of wind turbines and photovoltaic systems.



KTW Umweltschutztechnik GmbH

Magdalaer Str. 102a, 99441 Mellingen
 Tel.: +49 (0)36453 8750
 Fax: +49 (0)36453 87511
 E-Mail: info@ktweimar.de
www.ktweimar.de
 KTW Umweltschutztechnik GmbH provides foundations and towers with highly elastic seals and coatings, concrete repair and strengthening with life-tested products (even at high altitude, for example hybrid towers).



ROBUR Wind GmbH

Konsul-Smidt-Str. 71, 28217 Bremen
 Tel.: +49 (0)421 39987-0
 Fax: +49 (0)421 39987-11
 E-Mail: info.wind@robur-group.com
www.robur-wind.com
 ROBUR WIND combines all competencies in the construction, installation, inspection and maintenance, major component replacement and obstacle marking of onshore and offshore wind turbines.



Grzib Elektrotechnik GmbH & Co. KG

Zur Kokerei 21, 46117 Oberhausen
 Tel.: +49 (0)208 884839-24
 Fax: +49 (0)208 884839-26
 E-Mail: info@grzib-elektrotechnik.de
www.grzib-elektrotechnik.de
 Electrical installation of wind turbines throughout Europe | Maintenance & service of transformers, MV switchgears, converters



Monsson Operation GmbH

Ballindamm 3, 20095 Hamburg
 Tel.: +49 (0)40 3010 4470
 Fax: +49 (0)40 3010 4299
 E-Mail: germany@monsson.eu
www.monsson.eu
 Monsson Operation GmbH delivers a complete package of managed services for renewable assets, with a strong focus on onshore wind farms and solar power plants.



RoSch Industrieservice GmbH

Bernardstr. 29, 49809 Lingen
 Tel.: +49 (0)591 800990-0
 Fax: +49 (0)591 800990-19
 E-Mail: info@rosch-industrieservice.de
www.rosch-industrieservice.de
 We offer our clients worldwide a reliable, professional service for flawless, efficient operation of complete wind turbines, both on- and offshore.



Helling GmbH

Spökerdamm 2, 25436 Heidgraben
 Tel.: +49 (0)4122 922-0
 Fax: +49 (0)4122 922-201
 E-Mail: info@helling.de
www.helling.de
 The company HELLING GmbH based in the north of Germany is a leading manufacturer of systems, devices, reference blocks/test panels and test equipment for non-destructive material testing (NDT).



N.T.E.S. GmbH

Handelshof 8, 27432 Bremervörde
 Tel.: +49 (0)4761 92612-0
 Fax: +49 (0)4761 92612-99
 E-Mail: wkas@ntes-service.de
www.ntes-service.de
 Wind turbines: Maintenance, repair, inspection, measurement; thermography for Bonus/Siemens turbines.



Rotor Control GmbH

Kennedy Weg 3, 25821 Struckum
 Tel.: +49 (0)4671 933440-0
 Fax: +49 (0)4671 933440-19
 E-Mail: info@rotor-control.de
www.rotor-control.de
 Your partner for maintenance, repair and assessment of rotor blades/towers irrespective of WTG type or hub height, wind turbine maintenance and expert advice according to BDSH.



Wind assessment advisory board



Financing advisory board



Communication advisory board



Legal advisory board



Planning advisory board



RTS Wind AG

Am Winterhafen 3a, 28217 Bremen
 Tel.: +49 (0)421 696800-00
 Fax: +49 (0)421 696800-99
 E-Mail: info@rts-wind.de
 www.rts-wind.de

RTS Wind AG is a global service provider in the field of installation, operation and maintenance of wind turbines – onshore and offshore – as well as rotor blade service.

VSB Technik GmbH

Schweizer Str. 3a, 01069 Dresden
 Tel.: +49 (0)351 21183-400
 Fax: +49 (0)351 21183-44
 E-Mail: info@vsb.energy
 www.vsb.energy

Maintenance and repair of wind power plants, 24/7 online remote surveillance, spare part management, rotor-blade scan, testing in accordance with DGUV 3, repowering



Technical & commercial operational management



ABO Wind AG

Oberdorfstr. 10, 55262 Ingelheim
 Tel.: +49 (0)6132 8988-00
 Fax: +49 (0)6132 8988-29
 E-Mail: kontakt@abo-wind.de
 www.abo-wind.com

Technical & commercial operations management, 24/7 remote monitoring, contract management, permit requirements: ABO Wind manages and optimises plants with a capacity of 1,700 megawatts across Europe.



Sulzer & Schmid Laboratories AG

Industriestr. 9, CH-8618 Oetwil am See
 Tel.: +41 (0)55 5081715
 E-Mail: info@sulzerschmid.ch
 www.sulzerschmid.ch

Sulzer Schmid is a leading provider and innovator of next-generation technology for inspections of wind turbines using autonomous drones and a sophisticated data analytics platform.



windcomp GmbH

Glogauer Str. 21, 10999 Berlin
 Tel.: +49 (0)30 3198554-75
 Fax: +49 (0)30 3198554-99
 E-Mail: info@windcomp.de
 www.windcomp.de

windcomp is an expert for the optimization of wind turbines. We detect aerodynamic and mass imbalances quickly and precisely with the ROMEG method, during normal turbine operations.



AIRWIN GmbH

Bei der Abtspferdetränke 2, 21335 Lüneburg
 Tel.: +49 (0)4131 22703-10
 Fax: +49 (0)4131 22703-11
 E-Mail: info@airwin.de
 www.airwin.de

AIRWIN GmbH is an operations management and consulting company in the field of renewable energies with locations in Lüneburg, Berlin and Mainz.



TOP seven GmbH & Co.KG

Schiffbauweg 1, 82319 Starnberg
 Tel.: +49 (0)8151 95966-0
 E-Mail: info@topseven.com
 www.topseven.com

TOPseven combines autonomous, drone based and visual rotor blade and tower inspections for on- and offshore wind turbines with non-contact lightning protection testing – fast, precise, and efficient.



Winergy

Am Industriepark 2, 46562 Voerde
 Tel.: +49 (0)2871 92-4
 Fax: +49 (0)2871 92-2487
 E-Mail: info@winergy-group.com
 www.winergy-group.com

Winergy, headquartered in Voerde, Germany, is a leading drive train component manufacturer for wind turbines. It has supplied over 175 GW gearbox capacity and more than 50,000 generators worldwide.



BGZ Fondsverwaltung GmbH

Otto-Hahn-Str. 12–16, 25813 Husum
 Tel.: +49 (0)4841 8944-825
 Fax: +49 (0)4841 8944-840
 E-Mail: info@bgz-gmbh.de
 www.bgz-gmbh.de/en
 Management and repowering of renewable energy farms.



Triflex GmbH & Co. KG

Karlstr. 59, 32423 Minden
 Tel.: +49 (0)571 38780-0
 Fax: +49 (0)571 38780-738
 E-Mail: info@triflex.de
 www.triflex.com

Triflex is Europe's leading manufacturer of PMMA liquid plastic waterproofing systems and, with Triflex Towersafe, offers an excellent waterproofing solution for the tower and foundation area of wind turbines.



Deutsche WindGuard

Oldenburger Str. 65, 26316 Varel
 Tel.: +49 (0)4451 9515-0
 Fax: +49 (0)4451 9515-29
 E-Mail: info@windguard.de
 www.windguard.com

Techn./comm. management (on- & offshore) DIN 31051, condition oriented maintenance, maintenance/repair management, monitoring, plant/operator responsibility acc. to VDE 0105-100; IT safety standards



Manufacturer and supplier advisory board



Expert consulting advisory board



Investors' advisory board



Expert consulting advisory board



Scientific advisory board



Operators' advisory board



Dirkshof / EED GmbH & Co. KG

Sönke-Nissen-Koog 58, 25821 Reußenköge
 Tel.: +49 (0)4674 9629-0
 Fax: +49 (0)4674 8279999
 E-Mail: info@dirkshof.de
 www.dirkshof.de
 Dirkshof – Renewable Energy.
 German Expertise in Wind Energy – since 1989.



GP JOULE Service GmbH & Co. KG

Cecilienkoog 16, 25821 Reußenköge
 Tel.: +49 (0)4671 6074-0
 Fax: +49 (0)4671 6074-119
 E-Mail: info@gp-joule.de
 www.gp-joule.de
 GP JOULE SERVICE takes care of the commercial and technical management – as go-getter, thinker, ongoing improver and manager. We stand for certified quality, across Germany and internationally.



NATEN Betriebsführung GmbH

Otto-Lilienthal-Str. 13, 49134 Wallenhorst
 Tel.: +49 (0)5407 8036960
 E-Mail: info@naten.de
 www.naten.de
 Harvest a maximum of sun and wind. We have reliably managed the operation of your solar and wind energy plants and associated infrastructure across Germany for more than 15 years.



EnBW Energie Baden-Württemberg AG

Durlacher Allee 93, 76131 Karlsruhe
 Tel.: +49 (0)711 28989844
 E-Mail: betriebsfuehrung-wind@enbw.com
 www.enbw.com
 We ensure the economic and environmentally friendly operation of a wide variety of wind power plant types and sizes with 24/7 remote monitoring.



Green Wind Group

Alt-Moabit 60a, 10555 Berlin
 Tel.: +49 (0)30 3512886-30
 Fax: +49 (0)30 3512886-33
 E-Mail: info@greenwindgroup.de
 www.greenwindgroup.de
 Green Wind Operations GmbH is part of the Green Wind Group headquartered in Berlin, with offices in Copenhagen and Aarhus. We offer technical and commercial management for wind turbines and substations.



OSTWIND management GmbH

Oskar-Sembach-Ring 11, 91207 Lauf a. d. Pegnitz
 Tel.: +49 (0)9123 15731-10
 Fax: +49 (0)9123 15731-99
 E-Mail: management@ostwind.de
 www.ostwind.de
 OSTWIND operational management offers customer-optimised service packages – tailored to the specific needs of every wind farm and carefully adapted to the framework conditions set by the EEG.



energy consult GmbH

Peter-Henlein-Str. 2–4, 27472 Cuxhaven
 Tel.: +49 (0)4721 71808
 Fax: +49 (0)4721 718399
 E-Mail: info@energy-consult.net
 www.energy-consult.net
 Specialist in the technical and commercial management of wind farms as well as the inspection, technical evaluation and in the provision of comprehensive safety technology for wind turbine generators.



juwi Operations & Maintenance GmbH

Energie-Allee 1, 55286 Wörrstadt
 Tel.: +49 (0)6732 96575090
 Fax: +49 (0)6732 96577001
 E-Mail: info@juwi-om.de
 www.juwi-om.de
 Your energy systems are in good hands: our complete technical, commercial management and maintenance package ensures optimal yields and the best returns for wind energy and PV systems.



Regenerative Energien Zernsee GmbH & Co. KG

Bergstr. 1, 12169 Berlin
 Tel.: +49 (0)30 2244598-30
 Fax: +49 (0)30 2244598-31
 E-Mail: info@rez-windparks.de
 www.rez-windparks.de
 Our services include management and site management, as well as technical and commercial wind farm, substation, and solar plant management.



ENERTRAG WindStrom GmbH

Gut Dauerthal, 17291 Dauerthal
 Tel.: +49 (0)39854 6459-200
 E-Mail: betrieb@enertrag.com
 betrieb.enertrag.com
 The wind power optimisers: We offer commercial and technical competence from over 20 years of experience in managing systems under the German Renewable Energy Act.



Kaiserwetter Energy Asset Management GmbH

Hopfenmarkt 33, 20457 Hamburg
 Tel.: +49 (0)40 530566-0
 Fax: +49 (0)40 530566-199
 E-Mail: ror@kaiserwetter.eu
 www.kaiserwetter.energy/
 Kaiserwetter is an IntelliTech company in the renewable energy industry. The company uses the Internet of Things and Artificial Intelligence for its Data as a Service (DaaS) approach.



Sabowind Service GmbH

Frauensteiner Str. 118, 09599 Freiberg
 Tel.: +49 (0)3731 2608-60
 Fax: +49 (0)3731 2608-61
 E-Mail: service@sabowind.de
 www.sabowind.de/service
 Technical and commercial management of wind energy turbines and photovoltaic systems in Germany and Poland, maintenance, service as well as large component replacement.





THEOLIA Natureenergien GmbH

Ulmer Str. 4, 70771 Leinfelden-Echterdingen
 Tel.: +49 (0)711 23860-0
 Fax: +49 (0)711 23860-99
 E-Mail: kundenservice@futuren-group.com
 www.windparkbetreuung.de
 Technical and commercial operational managers with modular operational management concept.



WestWind Service GmbH & Co. KG

Brinkstr. 25, 27245 Kirchdorf
 Tel.: +49 (0)4273 9339-0
 Fax: +49 (0)4273 9339-44
 E-Mail: webkontakt@w-wind.de
 www.w-wind.de
 Service, operation and maintenance as well as technical and commercial management.

Organisations & public institutions

Associations



Volta Windkraft GmbH

Tückelhäuser Str. 10, 97199 Ochsenfurt
 Tel.: +49 (0)9331 98494-0
 Fax: +49 (0)9331 98494-20
 E-Mail: info@voltawind.de
 www.voltawind.de
 Planning and construction of wind turbines including supervision of the approval process, technical and commercial operational support, and support and implementation of citizen-owned wind turbines.



Windwärts Energie GmbH

Hanomaghof 1, 30449 Hannover
 Tel.: +49 (0)511 123573-0
 Fax: +49 (0)511 123573-190
 E-Mail: info@windwaerts.de
 www.windwaerts.de
 Windwärts ensures everything runs smoothly when operating wind and solar plants: From commercial and technical operational management to business management and continued operation post-EEG.



German Renewable Energy Federation (BEE)

EUREF-Campus - Haus 16, 10829 Berlin
 Tel.: +49 (0)30 2758170-0
 Fax: +49 (0)30 2758170-20
 E-Mail: info@bee-ev.de
 www.bee-ev.de
 As the umbrella organisation of the German renewables sector, BEE brings together the interests of 55 associations, organisations and enterprises. It has 30,000 members, more than 5,000 of which are companies.



VSB Service GmbH

Schweizer Str. 3a, 01069 Dresden
 Tel.: +49 (0)351 21183-400
 Fax: +49 (0)351 21183-44
 E-Mail: info@vsb.energy
 www.vsb.energy/service
 Technical and commercial management for wind and solar farms as well as substations, 24/7 online remote surveillance, direct marketing, occupational safety, managing of insurances and contracts.



Wittgenstein Wind

Schloss Wittgenstein 1, 57334 Bad Laasphe
 Tel.: +49 (0)2752 509760
 Fax: +49 (0)2752 50976299
 E-Mail: info@wittgenstein-wind.de
 www.wittgenstein-wind.de
 A partner you can rely on. Whether it is technical or operational management, we treat your plants like our own. Reducing downtimes, optimising turbines, developing wind farms!



German Wind Energy Association (BWE)

EUREF-Campus – Haus 16, 10829 Berlin
 Tel.: +49 (0)30 212341-210
 Fax: +49 (0)30 212341-410
 E-Mail: info@wind-energie.de
 www.wind-energie.de
 With about 20,000 members, the BWE is one of the world's largest associations for renewable energies. It has been advocating the sustainable and efficient expansion of wind energy and the best possible use of wind power.



WEB Andresen GmbH

Husumer Str. 51c, 25821 Breklum
 Tel.: +49 (0)4671 94301-10
 Fax: +49 (0)4671 94301-69
 E-Mail: info@web-andresen.de
 www.web-andresen.de
 Since 1991 the ultimate philosophy of WEB Andresen is to enable all local residents to directly participate in the energy revolution, loyal and cooperative, for pure and real citizen energy.



wpd windmanager GmbH & Co. KG

Stephanitorsbollwerk 3, 28217 Bremen
 Tel.: +49 (0)421 8976600
 E-Mail: windmanager@wpd.de
 www.windmanager.de
 wpd windmanager is Germany's leading and internationally expanding company in the commercial and technical management of wind farms and solar projects.



Global Wind Energy Council

Rue Belliard 51–53, B-1000 Brussels
 Tel.: +32 (0)490 568139
 E-Mail: info@gwec.net
 https://gwec.net
 As wind power expands to new markets, the Global Wind Energy Council serves as the authoritative global voice to communicate wind power's benefits, policy recommendations and role in economic recovery.



Manufacturer and supplier advisory board



Expert consulting advisory board



Investors' advisory board



Expert consulting advisory board



Scientific advisory board



Operators' advisory board

Institutions



WTSH – Business Development and Technology Transfer Corporation of Schleswig-Holstein GmbH

Lorentzendam 24, 24103 Kiel

Tel.: +49 (0)431 66666-878

E-Mail: hamel@wtsh.de

www.wtsh.de

Schleswig-Holstein offers a positive climate for investing in the wind energy industry. And WTSH provides as a competent partner advice for founding, expanding or relocating businesses.

Dismantling and recycling



AK Fehmarn GmbH & Co. KG

Meeschendorf 72, 23769 Fehmarn

Tel.: +49 (0)437 18889305

E-Mail: office@ak-fehmarn.de

www.ak-fehmarn.com

Your reliable partner in the field of wind energy.

Use our experience to your advantage. You can

find our services at any time and conveniently at

www.ak-fehmarn.de

Media & communication



German Wind Energy Association (BWE) - Corporate Publishing

EUREF-Campus – Haus 16, 10829 Berlin

Tel.: +49 (0)30 212341-164

E-Mail: WID-Redaktion@wind-energie.de

www.windindustrie-in-deutschland.de

With our long years of experience as a publisher we'll gladly implement your own project in the field of renewable energies. We work with various service providers to realise your desired project quickly and according to your wishes.



Other services



Kreuzwind Schmieder & Schmidt GbR

Meschwitzstr. 21, 01099 Dresden

Tel.: +49 (0)162 7916468

E-Mail: s.schmieder@kreuzwind.com

www.kreuzwind.com

Your reliable partner for dismantling and re-utilising any type of wind turbine. From controlled disassembly to site re-naturation – all from a single source!



new energy / neue energie

EUREF-Campus – Haus 16, 10829 Berlin

Tel.: +49 (0)30 212341-141

E-Mail: service@neueenergie.net

www.neueenergie.net

neue energie is the magazine for those interested in energy policy. It is read by the entire renewables sector.

Development & construction



enovation GmbH

Straße am Zeltplatz 7, 18230 Ostseebad Rerik

Tel.: +49 (0)381 203792-190

Fax: +49 (0)381 203792-101

E-Mail: Stefan.bockholt@eno-vation.com

www.eno-vation.com

Your address for German engineer know-how, consulting, wind turbine licenses and inspection services.

Human resource services



AllCon Service & Dienstleistungs GmbH

Gotenstr. 4, 20097 Hamburg

Tel.: +49 (0)40 238848-0

Fax: +49 (0)40 238848-48

E-Mail: info@allcon.eu

www.allcon.eu

Established in Windsince almost 17 years, certified to SCP and DIN ISO 9001 we assist you in maintaining and erecting wind turbines. Both onshore and offshore. Around the world using service technicians.

Nölting GmbH – EXPERTEN FÜR VERTRIEBSUNTERSTÜTZENDE KOMMUNIKATION

Gottesweg 127, 50939 Köln

Tel.: +49 (0)221 846121-60

Fax: +49 (0)221 846121-60

E-Mail: info@noelting.gmbh

www.noelting.gmbh

Benefit from 20 years of expertise in sales and marketing and our international renewable energy network for your digital marketing strategy.



RECASE Regenerative Energie GmbH

Alte Landstr. 1, 24866 Busdorf

Tel.: +49 (0)4621 4216640

Fax: +49 (0)4621 4216648

E-Mail: info@recase.de

www.recase.de/home/

RECASE is an engineering company with expertise and experience in on- and offshore wind industry in Europe and overseas.



Metering operations



DEUTSCHE
WINDGUARD

SCADA
international

in.power

in.power metering GmbH

An der Fahrt 5, 55124 Mainz
Tel.: +49 (0)6131 69657-222
Fax: +49 (0)6131 69657-29

E-Mail: msb@inpower-metering.de
www.inpower-metering.de

in.power metering's German-wide services specialised in RE: online data logging, park control for accounting, continued operation (e.g. mixed parks), remote control, feed-in management signals

Deutsche WindGuard

Bundesallee 67, 12161 Berlin
Tel.: +49 (0)30 223200-10

Fax: +49 (0)30 223200-24
E-Mail: systems@windguard.de
www.windguard.com

Wind farm management system WONDER for technical and asset management: data acquisition and analysis, lifecycle record, control centre, watchdog, feed-in management, reporting.

SCADA International A/S

A. C. Illums Vej 4A, DK-8600 Silkeborg
Tel.: +45 (0)9641 9200

E-Mail: scada@scada-international.com
www.scada-international.com

SCADA International empowers the renewable energy sector through unparalleled SCADA expertise. We support the full SCADA value chain across SCADA hardware and software, installation and commissioning into consulting.

Occupational safety and health



Blacksafe GmbH

Georg-Hardt-Str. 7, 83624 Otterfing
Tel.: +49 (0)8024 476635-0
Fax: +49 (0)8024 476635-2

E-Mail: info@blacksafe.de
www.blacksafe.de

We are your reliable partner for height safety, fall arrest, rescue, rope access, PPE, arboristic and special solutions. Fast and competent thanks to over 25 years of experience and a large warehouse.

EMD Deutschland GbR

Breitscheidstr. 6, 34119 Kassel
Tel.: +49 (0)561 31059-60

Fax: +49 (0)561 31059-69
E-Mail: sales-de@emd.dk
www.emd.dk

Modular software for the planning, design and simulation of wind energy projects (windPRO) and decentralized energy projects (energyPRO). Online performance monitoring for wind farms (windOPS).



TRICON Assets GmbH

Mergenthalerstr. 42, 48268 Greven
Tel.: +49 (0)2571 5836450

Fax: +49 (0)2571 5836389
E-Mail: info@tricon-assets.de
www.tricon-assets.de

Software for technical and commercial plant management and for financial, system, project and contract management. All in One. TRIAss – WT



Software solutions



AURELO business IT-solutions GmbH

Fraunhoferstr. 13 (Wissenschaftspark), 24118 Kiel
Tel.: +49 (0)431 530200-0

Fax: +49 (0)431 530200-999
E-Mail: info@aurelo.de
www.aurelo.de

ERP-software (based on MS Dynamics NAV) for project-planning and operating companies: commercial management, contracts, projects, finance/controlling, fund management, CRM (contacts, tasks, documents)

greenmatch AG

Greifengasse 1, CH-4058 Basel
Tel.: +41 (0)61 3015000

E-Mail: info@greenmatch.ch
www.greenmatch.ch

Web-based financial software & financing expertise for renewable energies – structure, manage and market your investments in wind energy, photovoltaics, hydropower and biomass!

green[::]match

Trade fairs & conferences for the wind energy industry



Hamburg Messe und Congress GmbH

Messeplatz 1, 20357 Hamburg
Tel.: +49 (0)40 3569-2263

Fax: +49 (0)40 3569-692263
E-Mail: andreas.arnheim@hamburg-messe.de
www.windenergyhamburg.com/en

The world's leading event for wind energy.

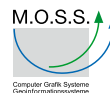

M.O.S.S. Computer Grafik Systeme GmbH

Hohenbrunner Weg 13, 82024 Taufkirchen
Tel.: +49 (0)89 66675-100

Fax: +49 (0)89 66675-180
E-Mail: info@moss.de
www.moss.de

M.O.S.S. offers planning application services, as well as integration solutions and consulting services with respect to optimizing the processes of planning wind farms (WPPA).

Messe Husum & Congress GmbH & Co. KG

Am Messeplatz 12–18, 25813 Husum
Tel.: +49 (0)4841 902-0

Fax: +49 (0)4841 902-246
E-Mail: info@husumwind.com
www.husumwind.com

From 14–17 September 2021, the wind industry will meet in Husum. Over four days everything will revolve around wind energy and transformational future technologies.



Planning

Grids & grid connection



Deutsche Windtechnik Umspannwerke GmbH
 Hamburger Chaussee 25 (Gebäude N),
 24220 Flintbek
 Tel.: +49 (0)4347 71300-0
 Fax: +49 (0)4347 71300-13
 E-Mail: info-uw@deutsche-windtechnik.com
 www.deutsche-windtechnik.com
 Monitoring, fault elimination, operating and
 controlling, servicing, inspections, repair and
 management of substations.



Isoblock Schaltanlagen GmbH & Co. KG
 Anton-Storch-Str. 17, 49080 Osnabrück
 Tel.: +49 (0)541 95909-71
 Fax: +49 (0)541 95909-50
 E-Mail: peter.schriewer@isoblock.de
 www.isoblock.de
 Planning, production, installation, commissioning
 & service of medium and low voltage plants,
 transmission stations up to 36 kV, state-of-the-art
 grid protection and telecontrol, all with full service.



Moeller & Poeller Engineering GmbH (M.P.E.)
 Europaplatz 5, 72072 Tübingen
 Tel.: +49 (0)7071 138790
 E-Mail: info@moellerpoeller.de
 www.moellerpoeller.de
 Office Flintbek: Hamburger Chaussee 25,
 24220 Flintbek, Tel.: +49 (0)4347 8009650
 Grid connection for on and offshore wind and PV
 farms. Planning for substations. Power system studies.

Ein Unternehmen der EnBW



Netze BW GmbH – Division of services
 Schelmenwasenstr. 15, 70567 Stuttgart
 Tel.: +49 (0)711 289-46000
 Fax: +49 (0)721 914-20111
 E-Mail: dienstleistungen-hs@netze-bw.de
 www.netze-bw.de/dienstleistungen
 From engineering and approval planning to the
 construction of a turnkey transformer station, Netze
 BW ensures wind farms feed into the 110kV grid
 efficiently.



WT Energiesysteme GmbH
 Glogauer Str. 9, 01587 Riesa
 Tel.: +49 (0)3525 51328-0
 Fax: +49 (0)3525 51328-20
 E-Mail: info@wt-energiesysteme.de
 www.wt-energiesysteme.de
 WTE has successfully been building numerous
 electrotechnical facilities for 15+ years. We have
 specialized in planning, building, maintaining and
 modernizing substations.

Offshore



Deutsche WindGuard
 Oldenburger Str. 65, 26316 Varel
 Tel.: +49 (0)4451 9515-0
 Fax: +49 (0)4451 9515-29
 E-Mail: info@windguard.de
 www.windguard.com
 Technical due diligence, onshore and offshore plan-
 ning, offshore engineering consulting (ILA), offshore
 design, production and construction supervision,
 service and logistics concepts.



Ramboll
 Chilehaus C – Burchardstr. 13, 20095 Hamburg
 Tel.: +49 (0)40 302020-0
 E-Mail: info@ramboll.com
 www.ramboll.com
 Full range of services on offshore wind projects: from
 planning and project development, to design, procu-
 rement, implementation and follow-up on operation
 and maintenance, and finally decommissioning.

BUILDING TRUST



Sika Deutschland GmbH
 Rieter Tal, 71665 Vaihingen/Enz
 Tel.: +49 (0)172 293 2883
 Fax: +49 (0)7042 109-5102
 E-Mail: winkler.matthias@de.sika.com
 www.sika.de
 Protective coatings for wind turbines on- and
 offshore.



Tractebel Engineering GmbH
 Friedberger Str. 173, 61118 Bad Vilbel
 Tel.: +49 (0)6101 55-1445
 Fax: +49 (0)6101 55-1826
 E-Mail: info-de@tractebel.engie.com
 www.tractebel-engie.com/en/solutions/energy#re-
 newables
 Tractebel Engineering GmbH offers world-wide
 planning and consulting services for onshore and
 offshore wind farm projects according to ISO 17025.



TÜV SÜD Industrie Service GmbH
 Heidenkampsweg 51, 20097 Hamburg
 Tel.: +49 (0)40 840521-411
 Fax: +49 (0)40 840521-450
 E-Mail: offshore@tuvsud.com
 www.tuvsud.com/wind-power
 Offshore wind power: Certification, inspection,
 surveillance. Project certification, type certification,
 site assessment, approval & periodic inspection on
 turbine, lifting equipment, service lift



WIND-consult GmbH
 Reuterstr. 9, 18211 Bargeshagen
 Tel.: +49 (0)38203 507-25
 Fax: +49 (0)38203 507-23
 E-Mail: company@wind-consult.de
 www.wind-consult.de
 Offshore – Meteorological Measurements on
 Offshore Research Platform FINO 2, Measurements
 on WT, Site Assessments-Wind and Energy Yield



Planners & project developers



ENERGY

3Energy Unternehmensgruppe

Am Steinberg 7, 09603 Großschirma

Tel.: +49 (0)37328 898-0

Fax: +49 (0)37328 898-299

E-Mail: info@3energy.eu

www.3energy.eu

Tailored solutions in the field of sustainable and local energy generation and supply. From a single source – under one roof.



ABO WIND

ABO Wind AG

Unter den Eichen 7, 65195 Wiesbaden

Tel.: +49 (0)611 26765-0

Fax: +49 (0)611 26765-599

E-Mail: kontakt@abo-wind.de

www.abo-wind.de

ABO Wind acquires, plans, finances and builds turnkey wind energy projects. In addition, ABO Wind sells project rights or collaborates with other developers to help their projects succeed.



BBWind Projektberatungsgesellschaft mbH

Schorlemerstr. 12–14, 48143 Münster

Tel.: +49 (0)251 981103-10

Fax: +49 (0)251 981103-29

E-Mail: info@bbwind.de

www.bbwind.de

BBWind specialises in real citizen wind projects, advising you from the initial idea to the technical and commercial management. Our motto: „Don't lease it, use it!“



BMR energy solutions GmbH

Berliner Ring 11, 52511 Geilenkirchen

Tel.: +49 (0)2451 91441-0

Fax: +49 (0)2451 91441-29

E-Mail: info@bmr-energy.com

www.bmr-energy.com

Wind energy – photovoltaics – bioenergy – sector coupling – consultancy – planning – financing – implementation



Dunoair Windpark Planung GmbH

Hawstr. 2a, 54290 Trier

Tel.: +49 (0)651 999889-13

Fax: +49 (0)651 999889-99

E-Mail: c.wuertz@dunoair.com

www.dunoair.com/en

As a specialist for the planning, construction and management of sites for wind power plants in Germany and abroad, we promote climate and environmental protection.



Energiequelle GmbH

Hauptstr. 44, 15806 Zossen OT Kallinchen

Tel.: +49 (0)33769 871-100

Fax: +49 (0)33739 871-105

E-Mail: info@energiequelle.de

www.energiequelle.de

Project planning, construction and operational management of wind, biogas and photovoltaic plants and storage facilities, transformer stations as well as innovative energy concept planning.



EDF EN Deutschland GmbH

Friedrich-Ebert-Str. 38–40, 25421 Pinneberg

Tel.: +49 (0)4101 408890

Fax: +49 (0)4101 408891

E-Mail: info@edf-re.de

www.edf-re.de

Planning, realisation, construction, repowering, operational management and administration of wind farms.



ENERTRAG AG

Gut Dauerthal, 17291 Dauerthal

Tel.: +49 (0)39854 6459-0

Fax: +49 (0)39854 6459-410

E-Mail: enertrag@enertrag.com

www.enertrag.com

ENERTRAG is an expert in the project management, financing, building & operation of wind turbines, and also in the design and development of energy storage solutions.



ee planung gmbh

Industriestr. 14, 25813 Husum

Tel.: +49 (0)4841 98104-10

Fax: +49 (0)4841 98104-99

E-Mail: buero@eeplanung.de

https://eeplanung.de/

Our electrical engineering office was founded in 2004. We offer planning, project management, power system protection and much more. Trust our experience – we can do it!



EnerVest AG

Maximilianstr. 47, 80538 Munich

Tel.: +49 (0)89 23239293-0

Fax: +49 (0)89 23239293-49

E-Mail: contact@enervest.eu

www.enervest.eu

As an investment company EnerVest AG is installing wind parks in Europe, and in particular in Germany.



EnBW Energie Baden-Württemberg AG

Durlacher Allee 93, 76131 Karlsruhe

Tel.: +49 (0)721 6315382

E-Mail: direktvermarktung@enbw.com

www.enbw.com/direktvermarktung

Optimal marketing, individual concepts for continued operation even without EEG funding (PPA).

As one of the leading direct marketers in Germany with a strong credit rating, we are a reliable partner.



envia THERM GmbH

Niels-Bohr-Str. 2, 06749 Bitterfeld-Wolfen

Tel.: +49 (0)3493 5167-0

Fax: +49 (0)3493 5167-4402

E-Mail: info@envia-therm.de

www.envia-therm.de

As a reliable and service-strong partner for wind energy projects, envia THERM covers all services from project development to construction, repowering and operational management.



Manufacturer and supplier advisory board



Expert consulting advisory board



Investors' advisory board



Expert consulting advisory board



Scientific advisory board



Operators' advisory board



EWE ERNEUERBARE ENERGIEN GmbH

Donnerschweer Str. 22–26, 26123 Oldenburg
 Tel.: +49 (0)441 48067-101
 Fax: +49 (0)441 48067-195
 E-Mail: erneuerbare@ewe.de
www.ewe-erneuerbare.de

Wind has been our passion for more than 30 years. We develop and implement wind farms, ensure optimised repowering and have fresh energy for partnerships.



GP JOULE GmbH

Cecilienkoog 16, 25821 Reußenköge
 Tel.: +49 (0)4671 6074-0
 Fax: +49 (0)4671 6074-119
 E-Mail: info@gp-joule.de
www.gp-joule.de

From green field to electricity and hydrogen station: As an integrated project partner, GP JOULE plans and implements energy and operating concepts with added value.



Jade NaturEnergie GmbH & Co. KG

Kronacher Str. 41, 96052 Bamberg
 Tel.: +49 (0)951 9649-777
 Fax: +49 (0)951 9649-778
 E-Mail: info@jadenaturenergie.de
www.jadenaturenergie.de

Jade NaturEnergie has been successfully planning and implementing projects in renewable energy for many years with the help of its experienced team.



EWE ERNEUERBARE regional GmbH

Vahrenwalder Str. 245–247, 30179 Hannover
 Tel.: +49 (0)511 260933-0
 Fax: +49 (0)511 260933-99
 E-Mail: info@ewe-erneuerbare-regional.de
www.ewe-erneuerbare.de

As a subsidiary of EWE ERNEUERBARE ENERGIEN with offices in Hanover and Husum we develop and realise wind farms and repowering projects – reliably and in dialogue.



Green City AG

Zirkus-Krone-Str. 10, 80335 München
 Tel.: +49 (0)89 890668 800
 Fax: +49 (0)89 890668 880
 E-Mail: ag@greencity.de
<https://ag.greencity.de>

Green City AG has been the pacemaker of the energy/transport transition since 2005. Core business: the project planning of power plants with a holistic approach (develop, buy, finance and operate).



juwi AG

Energie-Allee 1, 55286 Wörrstadt
 Tel.: +49 (0)6732 9657-0
 Fax: +49 (0)6732 9657-7001
 E-Mail: info@juwi.com
www.juwi.com

juwi is one of the leading specialists for wind and solar energy projects. In many projects we cooperate with regional project developers, energy suppliers and energy cooperatives.



GAIA mbH

Jahnstr. 28, 67245 Lamsheim
 Tel.: +49 (0)6233 35944-00
 Fax: +49 (0)6233 35944-01
 E-Mail: info@gaia-mbh.de
www.gaia-mbh.de

Your professional partner for planning, development, project coordination and storage solutions; servicing and technical management of wind turbines and photovoltaic systems as well as co-gen plants.



iE-Renewables | Ingenieurbüro für Erneuerbare Energien – Dr. Ingo Ewald

Pilgersberg 1, 55276 Oppenheim
 Tel.: +49 (0)6133 938293-0
 E-Mail: info@ie-renewables.de
www.ie-renewables.de

Professional and comprehensive consultancy services: regional as well as international project development, Due Diligence, contract negotiation/tendering, Repowering, Asset Management & more.



Landwind-Gruppe

Watenstedter Str. 11, 38384 Gevensleben
 Tel.: +49 (0)5354 9906-0
 Fax: +49 (0)5354 9906-109
 E-Mail: info@landwind-gruppe.de
www.landwind-gruppe.de

Site acquisitions, approval planning/project development of wind farms with public involvement, financing, grid connections, management of wind turbines and transformer stations, direct marketing.



GELSENWASSER AG

Willy-Brandt-Allee 26, 45891 Gelsenkirchen
 Tel.: +49 (0)209 708-727
 Fax: +49 (0)209 708-650
 E-Mail: michael.ramrath@gelsenwasser.de
www.gelsenwasser.de/wind

Rely on tried and tested all-round service that takes account of political, legal and technical demands. Careful planning and presence on site: The way to implement your wind energy project.



iTerra energy GmbH

Alter Schlachthof, Gottfried-Arnold-Str. 1a, 35398 Gießen
 Tel.: +49 (0)641 9446478-0
 Fax: +49 (0)641 9446478-29
 E-Mail: info@iterra-energy.de
www.iterra-energy.de

iTerra energy successfully implements wind farm projects in a cost and benefit-oriented manner and, based on many years of experience, is a solid and profitable partner for onshore wind farm projects.



MLK-Gruppe

Lichtenberger Weg 4, 15236 Jacobsdorf OT Sieversdorf
 Tel.: +49 (0)336 081799-97
 Fax: +49 (0)336 081799-98
 E-Mail: info@mlk-consult.de
www.mlk-windparks.de

Development, planning, implementation and operation of wind farms and other renewable energy plants. With emphasis on fair and socially participative projects.



Wind assesment advisory board



Financing advisory board



Communication advisory board



Legal advisory board



Planning advisory board



NaturStromProjekte GmbH

Bahnhofstr. 55, 91330 Eggolsheim
Tel.: +49 (0)3573 81 070-12
E-Mail: Erik.Heyden@naturstrom.de
www.naturstrom.de

We work with you and communities to develop new wind and solar projects. As a competent and fair partner with long years of experience we are a one stop shop for a unique allround service package.



NOTUS energy

Parkstr. 1, 14469 Potsdam
Tel.: +49 (0)331 62043-40
Fax: +49 (0)331 62043-44
E-Mail: windkraft@notus.de
www.notus.de

As an independent energy producer and project initiator we produce clean electricity. We plan, construct and operate wind farms and solar parks right from the initial concept to their final grid connection.



OSTWIND Erneuerbare Energien GmbH

Gesandtenstr. 3, 93047 Regensburg
Tel.: +49 (0)941 59589-0
Fax: +49 (0)941 59589-90
E-Mail: info@ostwind.de
www.ostwind.de

OSTWIND constructs wind farms and solar parks. Our expertise is underlined by 25 years of experience in the planning, construction and operational management of over 600 wind turbines and 1,058 MW.

Prowind GmbH

Rheiner Landstr. 195 a, 49078 Osnabrück
Tel.: +49 (0)541 60029-0
Fax: +49 (0)541 60029-29
E-Mail: info@prowind.com
www.prowind.com
Planning, development, construction and operation of regional renewable energy projects.



Ramboll

Magna Tower | Limbecker Platz 1, 45127 Essen
Tel.: +49 (0)201 43883-0
E-Mail: info@ramboll.com
www.ramboll.com

Ramboll is one of the top-ranking engineering consultants in Europe. We provide individualised services that cover the entire life cycle of on- and offshore wind projects.

planGIS GmbH

Kastanienallee 4, 26789 Leer
Tel.: +49 (0)491 796984-66
Fax: +49 (0)491 796984-67
E-Mail: info@plangis.de
www.plangis.de

planGIS prepares environmental reports (EIA, landscape planning, species conservation, visibility/visual impact analysis), immission control reports (noise/shadow) and restriction analyses.



PLANKon Ing.-Büro für Windenergieprojekte

Blumenstr. 26, 26121 Oldenburg
Tel.: +49 (0)441 39034-0
Fax: +49 (0)441 39034-22
E-Mail: mail@plankon.de
www.plankon.de

Studies/consultancy for wind yield, noise, shadow, wind measurements, planning, accr. test laboratory acc. to DIN 17025, authority and approval tender design, construction supervision, due diligence.



REA GmbH Management

Wernersstr. 23, 52351 Düren
Tel.: +49 (0)2421 972575-0
Fax: +49 (0)2421 972575-13
E-Mail: info@rea-dn.de
www.rea-dn.de

Consulting engineers specialising in the planning of wind energy and PV plants. Coordination of approval procedures, project implementation and plant operation. Specialists in community energy plants.



PNE AG

Peter-Henlein-Str. 2-4, 27472 Cuxhaven
Tel.: +49 (0)4721 718-06
Fax: +49 (0)4721 718-200
E-Mail: info@pne-ag.com
www.pne-ag.com

Development, realisation, operation and management of wind farms – international, onshore and offshore.



Rübsamen Windenergie GmbH

Osterholder Allee 2, 25421 Pinneberg
Tel.: +49 (0)4101 6967945
Fax: +49 (0)4101 8591444

E-Mail: info@ruebsamen-windenergie.de
www.ruebsamen-windenergie.de

Project development, construction, repowering, operation and management of wind parks inclusive of citizen participation both nationally and internationally.



Sabowind GmbH

Frauensteiner Str. 118, 09599 Freiberg
Tel.: +49 (0)3731 2608-0
Fax: +49 (0)3731 2608-26
E-Mail: info@sabowind.de
www.sabowind.de

Sabowind erects onshore wind energy turbines and photovoltaic plants as well as substations in Germany and Poland. For more than 25 years we put 270 wind turbines with 430 MW power into operation.



Schneider Consulting GmbH

Am Wiesenhang 21, 54516 Wittlich
Tel.: +49 (0)6571 95621-00
Fax: +49 (0)6571 95621-98
E-Mail: info@schneider-consulting.de
www.schneider-consulting.de

Project management General contractor Approval planning Dealing with authorities Environmental management Third party cables Documentation Structural survey GIS Access Rights of way Surveying Traffic mangement



Manufacturer and supplier advisory board



Expert consulting advisory board



Investors' advisory board



Expert consulting advisory board



Scientific advisory board



Operators' advisory board



Tractebel Engineering GmbH

Friedberger Str. 173, 61118 Bad Vilbel
 Tel.: +49 (0)6101 55-1445
 Fax: +49 (0)6101 55-1826
 E-Mail: info-de@tractebel.engie.com
 www.tractebel-engie.com/en/solutions/energy#renewables
 Tractebel Engineering GmbH offers world-wide planning and consulting services for onshore and offshore wind farm projects as well as wind expertises according to ISO 17025.



UKA – Umweltgerechte Kraftanlagen GmbH & Co. KG

Dr.-Eberle-Platz 1, 01662 Meißen
 Tel.: +49 (0)3521 7280-60
 Fax: +49 (0)3521 7280-6410
 E-Mail: zentrale@uka-gruppe.de
 www.uka-gruppe.de
 Wind and solar farm project development: site selection/securing, permit procurement, implementation, turnkey construction, repowering, operational management, project acquisition/collaboration.



Volkswind GmbH

Gustav-Weisskopf-Str. 3, 27777 Ganderkesee
 Tel.: +49 (0)4222 94138-0
 Fax: +49 (0)4222 94138-99
 E-Mail: info@volkswind.de
 www.volkswind.de
 Production of clean and renewable onshore wind energy.



VS Group

Schweizer Str. 3a, 01069 Dresden
 Tel.: +49 (0)351 21183-400
 Fax: +49 (0)351 21183-44
 E-Mail: info@vsb.energy
 www.vsb.energy
 VSB Group provides complete wind energy and photovoltaics solutions: from project development and implementing, right up to operations management as well as maintenance and repairs.

WestWind Projektierungs GmbH & Co. KG

Brinkstr. 25, 27245 Kirchdorf
 Tel.: +49 (0)4273 9339-0
 Fax: +49 (0)4273 9339-44
 E-Mail: webkontakt@w-wind.de
 www.w-wind.de
 Turnkey Projects (national and international), Construction Supervision, Finance and Repowering



WindStrom Erneuerbare Energien GmbH & Co. KG

Am Torfstich 11, 31234 Edemissen
 Tel.: +49 (0)5176 9204-0
 Fax: +49 (0)5176 9204-10
 E-Mail: info@windstrom.de
 www.windstrom.de
 We have been planning, building and operating wind farms since 1992 (440 turbines/908 MW). We offer project development, implementation, grid connection, comm. & techn. project & operat. management



Windwärts Energie GmbH

Hanomaghof 1, 30449 Hannover
 Tel.: +49 (0)511 123573-0
 Fax: +49 (0)511 123573-190
 E-Mail: info@windwaerts.de
 www.windwaerts.de
 We develop wind and solar energy projects from the initial idea through to commissioning with a primary focus on Lower Saxony, Schleswig-Holstein and the Ostwestfalen-Lippe region, in short: northern power.



WKN GmbH

Otto-Hahn-Str. 12–16, 25813 Husum
 Tel.: +49 (0)4841 8944-100
 Fax: +49 (0)4841 8944-225
 E-Mail: info@wkn-group.com
 www.wkn-group.com
 From site development, planning, financing and construction to operational management, WKN covers the entire value chain of a wind farm – nationally and internationally.

Repowering



Deutsche Windtechnik Repowering GmbH & Co. KG

Stephanitorsbollwerk 1 (Haus LEE), 28217 Bremen
 Tel.: +49 (0)421 69105-0
 Fax: +49 (0)421 69105-299
 E-Mail: l.schiermeyer@deutsche-windtechnik.com
 www.deutsche-windtechnik.com
 We offer all services related to repowering: buying and selling of turbines, dismantling, logistics, planning, refurbishment and storage.



EnBW Energie Baden-Württemberg AG

Schelmenwasenstr. 15, 70567 Stuttgart
 Tel.: +49 (0)711 289-48787
 E-Mail: windkraft@enbw.com
 www.enbw.com/post-EEG
 Purchase, dismantling, repowering, direct marketing: EnBW offers owners of existing wind farms a wide range of services from a single source in order to optimize the operating concept for the future.



Green Wind Group

Alt-Moabit 60a, 10555 Berlin
 Tel.: +49 (0)30 3512886-30
 Fax: +49 (0)30 3512886-33
 E-Mail: info@greenwindgroup.de
 www.greenwindgroup.de
 Green Wind Energy GmbH is part of the Green Wind Group with its headquarters in Berlin and offices in Copenhagen and Aarhus. GWE develops projects in Germany and Denmark with expertise and commitment.



Momentum Energy Deutschland GmbH

Lise-Meitner-Str. 4, 24941 Flensburg
 Tel.: +49 (0)461 97886630
 Fax: +49 (0)461 97886634
 E-Mail: info-de@momentum-gruppen.com
 www.momentum-gruppen.com
 Your value-creating partner for all aspects in Wind- and PV-projects. As a service provider from project development, repowering, construction, BNK, Surveys to technical and commercial management.





Sabowind GmbH

Frauensteiner Str. 118, 09599 Freiberg
Tel.: +49 (0)3731 2608-0
Fax: +49 (0)3731 2608-26
E-Mail: info@sabowind.de
www.sabowind.de/en

Replacement of old wind turbines by modern and more efficient ones, linked to the project planning, development and implementation. Further, we offer the completely dismantling of old wind turbines.



Windwärts Energie GmbH

Hanomaghof 1, 30449 Hannover
Tel.: +49 (0)511 123573-0
Fax: +49 (0)511 123573-190
E-Mail: info@windwaerts.de
www.windwaerts.de

Windwärts provides tailored solutions for any re-powering project – from assessing existing facilities and systems to project development to dismantling old and erecting new plant.

Suppliers of electrical and electronic components

Aviation obstruction markers & lighting systems



Lanthan GmbH & Co. KG

Jakobistr. 25A, 28195 Bremen
Tel.: +49 (0)421 696465-0
Fax: +49 (0)421 696465-11
E-Mail: info@lanthan.eu
www.lanthan.eu

Lanthan lighting systems are ensuring sustainable aviation safety on all 7 continents. The Lanthan Safe Sky demand-controlled night-time identification system then safely turns them off.



Parasol GmbH & Co. KG

Sönke-Nissen-Koog 58, 25821 Reußenköge
Tel.: +49 (0)4674 962920
Fax: +49 (0)4674 8279999
E-Mail: kontakt@passivradar.de
www.passivradar.de

Parasol in an aviation warning system – an affordable passive radar safety system which is considerate to both: local residents and wildlife.



GfM Gesellschaft für Maschinendiagnose mbH

Koepenicker Str. 325, 12555 Berlin
Tel.: +49 (0)30 65762565
Fax: +49 (0)30 65762564
E-Mail: mailbox@maschinendiagnose.de
www.maschinendiagnose.de

Fully automatic Online Condition Monitoring System
Peakalyzer | Mobile Machine Diagnosis System
PeakStore5 with optional Field Balancing Module



Gram & Juhl GmbH

Technologiepark 4, 26129 Oldenburg
Tel.: +49 (0)441 77931345
E-Mail: sales@gramjuhl.com
www.gramjuhl.com

Gram & Juhl is a world leading supplier of CMS. With close to 25,000 wind turbines embedded with the TCM® technology, Gram & Juhl has set new standards within preventive and predictive maintenance.

Sector coupling

Sector Coupling



GP JOULE Projects GmbH & Co. KG

Cecilienkoog 16, 25821 Reußenköge
Tel.: +49 (0)4671 6074-0
Fax: +49 (0)4671 6074-119
E-Mail: info@gp-joule.de
www.gp-joule.de

As an experienced project planner, closely connected to the region and defined by the conscientious use of resources, we stand for seamless re-powering projects and power refinement.

Condition monitoring systems



Bachmann Monitoring GmbH

Fritz-Bolland-Str. 7, 07407 Rudolstadt
Tel.: +49 (0)3672 3186-0
Fax: +49 (0)3672 3186-200
E-Mail: vertrieb-monitoring@bachmann.info
www.bachmann.info

Bachmann developed the first controller-integrated Condition Monitoring System for wind turbines. A specialist team of data analysts currently monitor 80 types of turbine and 6000 systems worldwide.



Weidmüller Group

Klingenbergstr. 26, 32758 Detmold
Tel.: +49 (0)5231 14291229
Fax: +49 (0)5231 1428116
E-Mail: Hans.Schlingmann@weidmueller.com
www.weidmueller.com/int/solutions/wind_solutions/index.jsp

Through a global development, production and sales network, we ensure that our customized solutions meet the requirements of the regional markets.



Schaeffler Monitoring Services GmbH

Kaiserstr. 100, 52134 Herzogenrath
Tel.: +49 (0)2407 9149-0
Fax: +49 (0)2407 9149-59
E-Mail: industrial-services@schaeffler.com
www.schaeffler.de/services

Schaeffler offers products and services for all aspects of condition monitoring. Thus maintenance operation costs can be reduced and the availability of wind turbines can be increased.



Wölfel Wind Systems GmbH
 Max-Planck-Str. 15, 97204 Höchberg
 Tel.: +49 (0)931 49708-0
 Fax: +49 (0)931 49708-150
 E-Mail: info@woelfel.de
 www.woelfel.de

On- and offshore monitoring systems for loads, damage and icing on rotor blades, towers and foundations to increase yields and optimize lifetime extension.



HELUKABEL GmbH
 Dieselstr. 8–12, 71282 Hemmingen
 Tel.: +49 (0)7150 92090
 Fax: +49 (0)7150 81786
 E-Mail: info@helukabel.de
 www.helukabel.de

Cables, wires and accessories for wind turbines: Wind power cables, control cables, power distribution cables, single conductors & computer data cables.



Rittal GmbH & Co. KG
 Auf dem Stützelberg, 35745 Herborn
 Tel.: +49 (0)2732 5052219
 E-Mail: hain.f@rittal.de
 www.rittal.com

Rittal GmbH & Co. KG is the world's leading supplier of control cabinets, power distribution, air conditioning, IT infrastructure and software & service for the protection and safe operation of electrical systems.

Controls, cables & switchgear cabinets



Bachmann electronic GmbH
 Kreuzäckerweg 33, A-6800 Feldkirch
 Tel.: +43 (0)5522 3497-0
 Fax: +43 (0)5522 3497-1102
 E-Mail: info@bachmann.info
 www.bachmann.info

Bachmann electronic offers sophisticated automation solutions for the onshore and offshore sectors. With over 110,000 installations worldwide, Bachmann is the global market leader in wind automation.



Kübler Group
 Schubertstr. 47, 78054 Villingen-Schwenningen
 Tel.: +49 (0)7720 3903-0
 Fax: +49 (0)7720 3903-846
 E-Mail: info@kuebler.com
 www.kuebler.com/en/wind

The Kübler Group is specialists for encoders and sensors to measure position, motion, and inclination, as well as slip rings for transmitting power, signals, and data.

Cooling & climatization



ELMEKO GmbH + Co. KG
 Graf-Zeppelin-Str. 5, 56479 Liebenscheid
 Tel.: +49 (0)2736 509748-0
 Fax: +49 (0)2736 509748-30
 E-Mail: info@elmeko.de
 www.elmeko.de

ELMEKO manufactures and distributes innovative premium components „made in Germany“ for switchgear cabinet air-conditioning, lighting and accessories.



Beckhoff Automation GmbH & Co. KG
 Wahmstr. 56, 23552 Lübeck
 Tel.: +49 (0)451 203988-0
 Fax: +49 (0)451 203988-20
 E-Mail: wind@beckhoff.com
 www.beckhoff.com/wind

More than 70,000 wind turbines all over the world have been automated using Beckhoff technology, each providing up to 10 MW capacity, including in regions with extreme climatic conditions.



PHOENIX CONTACT Deutschland GmbH
 Flachmarktstr. 8, 32825 Blomberg
 Tel.: +49 (0)5235 312000
 Fax: +49 (0)5235 312999
 E-Mail: windenergy@phoenixcontact.com
 www.phoenixcontact.com
 Phoenix Contact is a global leader in the field of electrical engineering, electronics and automation and a reliable wind industry partner.



STEGO Elektrotechnik GmbH
 Kolpingstr. 21, 74523 Schwaebisch Hall
 Tel.: +49 (0)791 95058 0
 Fax: +49 (0)791 95058 45
 E-Mail: info@stego.de
 www.stego.de

STEGO heating elements, regulators, fans, lamps and accessories protect your sensitive electronic components against harmful climatic influences.



Deutsche Windtechnik Steuerung GmbH & Co. KG
 Osterport 2f, 25872 Osterfeld
 Tel.: +49 (0)4843 20448-200
 Fax: +49 (0)4843 20448-299
 E-Mail: info-dwtstr@deutsche-windtechnik.com
 www.deutsche-windtechnik.com

Development and optimization of electronics used in wind turbines including sales, servicing, reproductions and consultation.

Prysmian Kabel und Systeme GmbH
 Alt-Moabit 91 D, 10559 Berlin
 Tel.: +49 (0)30 36754-0
 Fax: +49 (0)30 36754-571
 E-Mail: kontakt@prysmiangroup.com
 www.prysmiangroup.de
 Prysmian Group is world leader in the energy and telecom cable systems industry with almost 140 years of experience, sales exceeding €11 billion, 30,000 employees in over 50 countries & 112 plants.



Energy & data transmission



Weitkowitz GmbH

Woltorfer Str. 125, 31224 Peine
Tel.: +49 (0)5171 70610

E-Mail: info@weitkowitz.de
www.weitkowitz.de

Weitkowitz has been manufacturing and supplying cable terminals, connectors, ferrules, cable ties, pressing and cutting tools for over 100 years. We'd be glad to collaborate with you to develop special windsolutions.

Generators



ELIN Motoren GmbH

Elin-Motoren-Str. 1, A-8160 Weiz
Tel.: +43 (0)3172 90606-1000

E-Mail: contact@elinmotoren.at
www.elinmotoren.at/en

ELIN Motoren GmbH develops, produces and sells wind turbine generators based on various customer specific technical designs with a power range of 750 kW to currently 10 MW.

Light fittings & emergency light fitting



Wieland Electric GmbH

Brennerstr. 10-14, 96052 Bamberg
Tel.: +49 (0)951 9324-0

Fax: +49 (0)951 9324-198
E-Mail: info@wieland-electric.com
www.wieland-electric.com

As experts in LED lighting and safety technology, we support turbine manufacturers, tower builders and wind park operators with planning and executing the plans for wind parks.

Measurement equipment & measuring masts



anemos-jacob GmbH

Oldershausener Hauptstr. 22, 21436 Oldershausen
Tel.: +49 (0)4133 210696

Fax: +49 (0)4133 210695
E-Mail: wind@anemos-jacob.de
www.anemos-jacob.de

Selling and renting of IEC-compliant, classified Sodar-instruments.



Deutsche WindGuard

Oldenburger Str. 65, 26316 Varel
Tel.: +49 (0)4451 9515-0

Fax: +49 (0)4451 9515-29
E-Mail: info@windguard.de
www.windguard.com

Anemometer and wind vane calibration, calibration of LiDAR/SODAR, wind measurement systems sale, rotor blade profile measurement in an acoustically optimized wind tunnel, icing wind tunnel.



GWU-Umwelttechnik GmbH

Bonner Ring 9, 50374 Erftstadt
Tel.: +49 (0)2235 955220

Fax: +49 (0)2235 9552299
E-Mail: lidar@gwu-umwelttechnik.de
www.lidar-world.de

Sensors and systems for wind and wind profiling, mobile and stationary Doppler Wind LiDAR systems on different platforms: ground-based, nacelle-based, floating and airborne.



Megger GmbH

Weststr. 59, 52074 Aachen
Tel.: +49 (0)241 91380500

Fax: +49 (0)241 91380599
E-Mail: Peter.Wienhold@Megger.com
<https://de.megger.com>

Megger has been a global leader in electrical testing and mensuration technology for 130 years.



METEK Meteorologische Messtechnik GmbH

Fritz-Straßmann-Str. 4, 25337 Elmshorn
Tel.: +49 (0)4121 43590

Fax: +49 (0)4121 435920
E-Mail: info@metek.de

www.metek.de

Sensors and profilers for wind-/turbulence measurements: Doppler Sodar PCS.2000, Doppler Lidar Stream Line and Wind Ranger, ultrasonic anemometer uSonic, data logger mLog, rental service.

Safety features & equipment



SHE Solution Bergmann GmbH & Co. KG

Im Sundernkamp 2, 32130 Enger
Tel.: +49 (0)5224 9393850

Fax: +49 (0)5224 9393852
E-Mail: info@she-solution.de

www.she-solution.de

SHE Solution offers comprehensive solutions for the protection and safety at work. Our quality services range from providing convincing technical solutions to full-service. Taste the difference!



Manufacturer and supplier advisory board



Expert consulting advisory board



Investors' advisory board



Expert consulting advisory board



Scientific advisory board



Operators' advisory board

Sensors

BALLUFF

Balluff GmbH

Schurwaldstr. 9, 73765 Neuhausen

Tel.: +49 (0)7158 173-0

Fax: +49 (0)7158 5010

E-Mail: bernd.schneider@balluff.de

www.balluff.com

Sensor and automation solutions for the wind turbine and its manufacture



JUMO GmbH & Co. KG

Moritz-Juchheim-Str. 1, 36039 Fulda

Tel.: +49 (0)661 6003-0

Fax: +49 (0)661 6003-500

E-Mail: info@jumo.net

www.jumo.net

The JUMO product range includes the entire measuring chain from sensors to automation solutions for temperature, pressure, liquid analysis, flow rate, filling level and humidity.



Kübler Group

Schubertstr. 47, 78054 Villingen-Schwenningen

Tel.: +49 (0)7720 3903-0

Fax: +49 (0)7720 3903-846

E-Mail: info@kuebler.com

www.kuebler.com/safety

The Kübler Group belongs today to the leading specialists worldwide in the fields of position and motion sensors, functional safety, counting and process technology and transmission technology.

Transformers, converters & power resistors



airXite GmbH

Schlossstr. 33, 03205 Calau

Tel.: +49 (0)354 18879030

Fax: +49 (0)354 18879039

E-Mail: mail@airxite.com

www.airxite.com

electrical inspection incl. maintenance & repairs, low & medium voltage, transformer & switchgear exchange, rental transformer, grounding systems & seals, troubleshooting & suppression, multibrand

LIEBHERR

Liebherr-Components AG

Kirchweg 46, CH-5415 Nussbaumen AG

Tel.: +41 (0)56 296-4300

Fax: +41 (0)56 296-4301

E-Mail: components@liebherr.com

www.liebherr.com/components

Frequency converters for wind turbines with a power range from 2 MW to 5 MW.

Suppliers of large components

Foundations & footings



EEW Special Pipe Constructions GmbH

Am Eisenwerk 1, 18147 Rostock

Tel.: +49 (0)381 81716-0

Fax: +49 (0)381 81716-110

E-Mail: info@eewspc.de

www.eewspc.de

Foundation pipes & pipe components for offshore wind / oil & gas: Monopiles/Transition pieces, Prefabricated components for jackets, Pin piles for jackets, Suction piles.



KTW Umweltschutztechnik GmbH

Magdalaer Str. 102a, 99441 Mellingen

Tel.: +49 (0)36453 8750

Fax: +49 (0)36453 87511

E-Mail: info@ktweimar.de

www.ktweimar.de

KTW Umweltschutztechnik GmbH provides foundations and towers with highly elastic seals and coatings, concrete repair and strengthening with life-tested products (even at high altitude, for example hybrid towers).



Peter Chr. Petersen GmbH & Co. KG

Marktstra t 31, 25842 Langenhorn

Tel.: +49 (0)4672 7740-0

Fax: +49 (0)4672 7740-77

E-Mail: info@pcpetersen.de

www.pcp-bau.de

More than 20 years of experience in the following fields: pile driving, excavation work, water drainage, reinforced concrete work, and construction planning for foundations.



Rotor blades & rotor blade materials



Akzo Nobel Hilden GmbH c/o International Farbenwerke GmbH

Sachsenkamp 5, 20097 Hamburg
Tel.: +49 (0)40 72003-153
Fax: +49 (0)40 72003-110
E-Mail: wind.de@akzonobel.com
www.akzonobel.com
Coating systems for rotor blades – RELEST® Wind Gelcoat, putty, leading edge protection, miscellaneous topcoat and repair systems.



HAWART Sondermaschinenbau GmbH

Handwerksweg 8, 27777 Ganderkesee
Tel.: +49 (0)4222 941390
Fax: +49 (0)4222 9413960
E-Mail: info@hawart.de
www.hawart.de
HAWART has been a strong partner within the wind industry for over 30 years. We design, construct, manufacture and install a wide range of special solutions for wind turbine manufacturers around the world.



LAP GmbH Laser Applikationen

Zeppelinstr. 23, 21337 Lüneburg
Tel.: +49 (0)4131 951195
Fax: +49 (0)4131 951196
E-Mail: info@lap-laser.com
www.lap-laser.com
LAP produces laser projection systems proven worldwide in the manufacture of fiber-reinforced rotor blades and in parts assembly of wind turbine nacelle casings.

Towers



Max Bögl Wind AG

Postfach 1120, 92301/92369 Neumarkt i. d. Opf.
Tel.: +49 (0)9181 909-0
E-Mail: wind@max-boegl.de
www.mbrenewables.com
The future of wind energy lies in the most powerful turbine generations. These loads with record-breaking hub heights require a stable, economical pillar: the Hybrid Tower Bögl.



Ventur GmbH

Marienhütte 6, 57080 Siegen
Tel.: +49 (0)271 3189290
Fax: +49 (0)271 3189231
E-Mail: vertrieb-ventur@droessler.de
www.droessler-ventur.de
Development, production and installation of concrete towers for wind turbines. Simple and unrestricted due to a unique production, crane, transport and installation concept – available worldwide.

Suppliers of mechanical components

Access technology



Hailo Wind Systems GmbH & Co. KG

Kalteiche-Ring 18, 35708 Haiger
Tel.: +49 (0)2773 821410
Fax: +49 (0)2773 82181471
E-Mail: info@hailo-windsystems.com
www.hailo-windsystems.com
Hailo Wind Systems is one of the world's market and technology leaders for access solutions in wind turbines. Quality, reliability and safety always have top priority for our products and services.

Bearings



eolotec GmbH

Fürther Str. 176, 90429 Nürnberg
Tel.: +49 (0)911 239517-0
Fax: +49 (0)911 239517-29
E-Mail: info@eolotec.com
www.eolotec.com
Your experts for bearing systems in wind turbines offer customized new developments, RCA and redesigns as well as a comprehensive product portfolio in the area of retrofit solutions and sensors.

LIEBHERR

Liebherr-Components AG

Kirchweg 46, CH-5415 Nussbaumen AG
Tel.: +41 (0)56 29643-00
Fax: +41 (0)56 29643-01
E-Mail: components@liebherr.com
www.liebherr.com/bearings
With over 60 years of experience as a manufacturer of slewing bearings, Liebherr is a strong partner for the wind industry. Four-point-bearings and roller bearings with a diameter starting from 800 up to 7.500 mm.



Manufacturer and supplier advisory board



Expert consulting advisory board



Investors' advisory board



Expert consulting advisory board



Scientific advisory board



Operators' advisory board



Brakes

NSK Deutschland GmbH
Harkortstr. 15, 40880 Ratingen
Tel.: +49 (0)2102 481-0
Fax: +49 (0)2102 481-2151
E-Mail: info-de@nsk.com
www.nskeurope.com
NSK has been active in the field of wind energy for decades and is one of the main suppliers of gearboxes. Other focal points are bearings for main rotors and generators.

SCHAEFFLER

Schaeffler Technologies AG & Co. KG
Georg-Schäfer-Str. 30, 97421 Schweinfurt
Tel.: +49 (0)9721 91-0
Fax: +49 (0)9721 91-3435
E-Mail: info@schaeffler.com
www.schaeffler.de/windpower
Schaeffler is one of the world's leading bearing manufacturers. We produce solutions for the wind power sector ranging from individual bearings through to complete Industry 4.0 packages.

Bolts & fasteners



August Friedberg GmbH
Achternbergstr. 38, 45884 Gelsenkirchen
Tel.: +49 (0)209 9132-0
Fax: +49 (0)209 9132-178
E-Mail: info@august-friedberg.com
www.august-friedberg.com
Fasteners for wind turbines; HV tower bolt sets up to M80; Studs; Rotor blade connection systems; Application engineering and development partnership



Schraubenwerk Zerbst GmbH
Altbuchsland 22, 39261 Zerbst
Tel.: +49 (0)3923 713-0
Fax: +49 (0)3923 713-200
E-Mail: info@schraubenwerk.com
www.schraubenwerk.de/index_en.html
Screw fasteners for wind turbines and their components, HV sets up to M72 size, standard and specially designed screws, rotor blade fasteners, global delivery for assembly and to construction sites.



mayr Antriebstechnik
Eichenstr. 1, 87665 Mauerstetten
Tel.: +49 (0)8341 804-0
Fax: +49 (0)8341 421
E-Mail: info@mayr.com
www.mayr.com
Safety brakes for pitch/azimuth drives (yaw) in cold climate version (GL-certified up to -40°C), tower hoists, service lifts, lifting appliances, cranes, electromagnetic brakes for small wind turbines

Coupling



CENTA Antriebe Kirschey GmbH
Bergische Str. 7, 42781 Haan
Tel.: +49 (0)2129 912-0
Fax: +49 (0)2129 2790
E-Mail: centa@centa.de
www.centa.info
CENTA is part of Rexnord Industries. As a global leader in premium couplings, Rexnord provides the same high quality customer solutions and service you've come to expect from CENTA since 1891.



mayr Antriebstechnik
Eichenstr. 1, 87665 Mauerstetten
Tel.: +49 (0)8341 804-0
Fax: +49 (0)8341 421
E-Mail: info@mayr.com
www.mayr.com
Overload systems for wind turbine gearboxes; torque limiters for climbing aid drives in the tower; switchable clutches for the drives of maintenance platforms; large clutches for gearbox test stands

Gears



BRAUER Maschinentechnik AG
Raiffeisenring 25, 46395 Bocholt
Tel.: +49 (0)2871 7033
Fax: +49 (0)2871 7036
E-Mail: j.brauer@brauer-getriebe.de
www.brauer-getriebe.de
Repair and improvement of wind turbine gearboxes of all types and in every size.



Ernst Schad GmbH
Seilerstr. 8, 44147 Dortmund
Tel.: +49 (0)231 985123-0
Fax: +49 (0)231 985123-9
E-Mail: sales@ernst-schad.de
www.ernst-schad.de
Leading producer of spare parts for Wind, Turbo and Industrial gearboxes. Production according to drawing or sample Module 1 to 45, Outer diameter up to 2,000 mm. Special custom made solutions.

LIEBHERR

Liebherr-Components AG
Kirchweg 46, CH-5415 Nussbaumen AG
Tel.: +41 (0)56 29643-00
Fax: +41 (0)56 29643-01
E-Mail: components@liebherr.com
www.liebherr.com/gearboxes
Liebherr develops high-performance yaw and pitch gearboxes for the wind industry. Planetary gearings: up to module 50 at the output pinion and 600 kNm output torque.



Multigear GmbH
Am Flugplatz 34, 56743 Mendig
Tel.: +49 (0)2652 93605-0
Fax: +49 (0)2652 93605-20
E-Mail: info@multigear.de
www.multigear.de
Independent service company for gearboxes of all makes





Hydraulic components



NGC Transmission Europe GmbH

Schifferstr. 196, 47059 Duisburg
Tel.: +49 (0)203 5096000
Fax: +49 (0)203 50960190
E-Mail: wind-eu@NGCtransmission.com
www.NGCtransmission.de
NGC – Your global partner for wind turbine main gearboxes and pitch & yaw drives



HAWE Hydraulik SE

Einsteinring 17, 85609 Aschheim/München
Tel.: +49 (0)89 379100-1000
Fax: +49 (0)89 379100-91000
E-Mail: info@hawe.de
www.hawe.com
HAWE Hydraulik – your competent partner for modern, efficient and durable hydraulic solutions in all areas of the wind industry.

perma-tec GmbH & Co. KG

Hammelburger Str. 21, 97717 Euerdorf
Tel.: +49 (0)9704 609-0
Fax: +49 (0)9704 609-50
E-Mail: info@perma-tec.com
www.perma-tec.com/en
The global leader in single-point lubrication systems. Precise lubrication of e.g. azimuth and pitch bearings helps to optimize workplace safety by extended exchange intervals.



Stromag GmbH

Hansastr. 120, 59425 Unna
Tel.: +49 (0)2303 102-0
E-Mail: marco.niehnus@stromag.com
www.stromag.com

For more than 25 years Stromag has been an indispensable partner with an excellent reputation as a developer and manufacturer of intelligent braking systems and limit switches.



REWITEC GmbH

Dr.-Hans-Wilhelmi-Weg 1, 35633 Lahnu
Tel.: +49 (0)6441 44599-0
Fax: +49 (0)6441 44599-25
E-Mail: rewitec.info@croda.com
www.rewitec.com
REWITEC develops an innovative surface-treatment technology which is used to protect against wear and friction and to repair damaged surfaces in wind turbine gearboxes and bearings.



Liebherr-Components AG

Kirchweg 46, CH-5415 Nussbaumen AG
Tel.: +41 (0)56 296-4300
Fax: +41 (0)56 296-4301
E-Mail: components@liebherr.com
www.liebherr.com/cylinders
Hydraulic cylinders for the wind industry.



Winergy

Am Industriepark 2, 46562 Voerde
Tel.: +49 (0)2871 92-4
Fax: +49 (0)2871 92-2487
E-Mail: info@winergy-group.com
www.wineryg-group.com

Winergy, headquartered in Voerde, Germany, is a leading drive train component manufacturer for wind turbines. It has supplied over 175 GW gearbox capacity and more than 50,000 generators worldwide.

Lubricants & lubrication systems



ADDINOL Lube Oil GmbH

Am Haupttor, 06237 Leuna
Tel.: +49 (0)3461 845-0
Fax: +49 (0)3461 845-555
E-Mail: info@addinol.de
www.addinol.de
High-performance lubricants and greases made in Germany for wind turbines as well as demanding applications in industry and the automotive sector.

TOTAL Deutschland GmbH

Jean-Monnet-Str. 2, 10557 Berlin
Tel.: +49 (0)30 20276787
Fax: +49 (0)30 2027796634
E-Mail: rm.industrie@total.de
www.total.de/industrie
TOTAL is one of the world's leading suppliers in the industrial sector covering almost all areas of application for highly specialised lubricants, greases, and special applications.



BEKAWIND BAIER + KÖPPEL GmbH + CO. KG

Beethovenstr. 14, 91257 Pegnitz / Bayern
Tel.: +49 (0)9241 729-0
Fax: +49 (0)9241 729-50
E-Mail: m.fremann@beka-lube.de
www.beka-lube.de
BEKAWIND offers tailor-made and innovative maintenance solutions for each wind converter. BEKAWIND reduces wear and tear in a very efficient way and optimizes operational readiness.

Seals & vibration control



EFFBE GmbH

Hanauer Landstr. 16, 63628 Bad Soden-Salmünster
Tel.: +49 (0)6056 78-7964
Fax: +49 (0)6056 78-57964
E-Mail: jnspahn@effbe.de
www.effbe.de

Vibrator engineering & sealing with high performance elastomers, gearbox & generator mounts, torque arm, decoupling elements, CMS, R&D, manufacturing, test field, rubber & PUR, rubber-metal-comp



ESM Energie- u. Schwingungstechnik Mitsch GmbH

Energiestr. 1, 64646 Heppenheim
Tel.: +49 (0)6252 6893-0
Fax: +49 (0)6252 6893-100
E-Mail: info@esm-gmbh.de
www.esm-gmbh.de

The vibration technology specialists. We provide gearbox supports (e. g. elastomer hydraulic, clamping bushings), low- and high-frequency TMDs, decoupling elements, generator/cover mounts, couplings.



TECHNO-PARTS GmbH

Alte Bottroper Str. 81, 45356 Essen
Tel.: +49 (0)201 86606-0
Fax: +49 (0)201 86606-68
E-Mail: vk@techno-parts.de
www.techno-parts.de

Seals/guide elements for hydraulics, pneumatics, chemicals, plant construction as well as for almost all parts of a wind turbine (rotor blade, brake, generator, gearbox, main shaft bearing, nacelle)



Wölfel Wind Systems GmbH

Max-Planck-Str. 15, 97204 Höchberg
Tel.: +49 (0)931 49708-0
Fax: +49 (0)931 49708-150
E-Mail: info@woelfel.de
www.woelfel.de

Passive & active dampers for the reduction of low-frequency structural vibrations and structure-borne noise: measurement and analysis, design and development, production and installation.

Surface technology



Sika Deutschland GmbH

Rieter Tal, 71665 Vaihingen/Enz
Tel.: +49 (0)172 2932883
Fax: +49 (0)7042 109-5102
E-Mail: winkler.matthias@de.sika.com
www.sika.de

Protective coatings for wind turbines on- and offshore.

Synthetic Components



Röchling Engineering Plastics SE & Co. KG

Röchlingstr. 1, 49733 Haren
Tel.: +49 (0)5934 701-0
Fax: +49 (0)5934 701-299
E-Mail: info@roechling-plastics.com
www.roechling-industrial.com

For the development of wind turbines, Röchling offers a broad range of composites and thermoplastics used onshore and offshore by renowned manufacturers worldwide.

Tools & machine tools



alki TECHNIK GmbH

Unterlettenweg 4, 85051 Ingolstadt
Tel.: +49 (0)841 97499-0
Fax: +49 (0)841 97499-90
E-Mail: info@alkitronic.com
www.alkitronic.com/en

alkitronic® Home of Torque Power. We know your applications and tightening requirements. Our tools achieve highest torques with high precision and high operating speed. From 500 to 200,000 Nm.



HYTORC (Barbarino & Kilp GmbH)

Justus-von-Liebig-Ring 17,
82152 Krailling/near Munich
Tel.: +49 (0)89 230999-0
Fax: +49 (0)89 230999-14
E-Mail: p.junkers@hytorc.de
www.hytorc.de

HYTORC stands for reliable, digitalized, documented and mobile bolting (M16 to M100) whilst saving resources and improving quality in wind power applications.



M-PT Matjesch-PowerTools

Am Saegewerk 11, 01920 Ralbitz-Rosenthal
Tel.: +49 (0)35796 9760
Fax: +49 (0)35796 97610
E-Mail: mail@m-pt.de
www.m-pt.de

Authorized distributor of RAD Torque Systems! Battery torque wrench MAD (to 7.000 Nm), electric torque wrench MED and E-RAD (to 16.500 Nm) – also sensor-controlled. Rental, repair and calibration.





Plarad – Maschinenfabrik Wagner GmbH & Co. KG

Birrenbachshöhe 17, 53804 Much
Tel.: +49 (0)2245 62-0
Fax: +49 (0)2245 62-66
E-Mail: info@plarad.de
www.plarad.de

Founded in 1962, Maschinenfabrik Wagner and its brand Plarad has stood for quality, innovation and reliability in the bolting technology sector for 50 years now and is a pioneer in the wind industry.



SpanSet-Gruppe Deutschland

Winkelsweg 172, 40764 Langenfeld
Tel.: +49 (0)800 299466457
Fax: +49 (0)2173 2089228
E-Mail: info@axzion.de
www.axzion.de

SpanSet Axzion GmbH, a company within the SpanSet Group Germany with its own production facilities, specialises in load handling attachments for international on- and offshore wind power turbines.

Transport & logistics

Crane companies, crane hire & special transport

LIEBHERR

Liebherr-MCCTec Rostock GmbH

Liebherrstr. 1, 18147 Rostock
Tel.: +49 (0)381 6006-0
Fax: +49 (0)381 6006-3999
E-Mail: info.mcr@liebherr.com
www.liebherr.com

Production of offshore cranes with lifting capacities of up to 5,000 t. Liebherr in Rostock offers the TCC 78000 heavy-lift crane with a load capacity of 1,600 t and a lifting height of 112 m for material handling.

LIEBHERR

Liebherr-Werk Biberach GmbH

Memminger Str. 120, 88400 Biberach
Tel.: +49 (0)7351 41-0
Fax: +49 (0)7351 41-2225
E-Mail: info.lbc@liebherr.com
www.liebherr.com
Fast-erecting cranes, top-slewing cranes, mobile construction cranes, special cranes for wind power

LIEBHERR

Liebherr-Werk Ehingen GmbH

Dr.-Hans-Liebherr-Str. 1, 89584 Ehingen
Tel.: +49 (0)7391 502-0
Fax: +49 (0)7391 502-3399
E-Mail: info.lwe@liebherr.com
www.liebherr.com
Telescopic crawler and mobile cranes up to 1,200 t, rough-terrain cranes up to 100 t, lattice boom mobile cranes 750 t, crawler track cranes up to 3,000 t, wind attachments, narrow track crawler chassis

LIEBHERR

Liebherr-Werk Nenzing GmbH

Dr.-Hans-Liebherr-Str. 1, A-6710 Nenzing
Tel.: +43 (0)50809 41-0
Fax: +43 (0)50809 41-500
E-Mail: info.lwn@liebherr.com
www.liebherr.com
Crawler cranes up to 400 t



Schmidbauer GmbH & Co. KG

Seeholzenstr. 1, 82166 Gräfelfing
Tel.: +49 (0)89 898676-0
Fax: +49 (0)89 851124
E-Mail: info@schmidbauer-gruppe.de
www.schmidbauer-gruppe.de
A powerful and innovative heavy-duty expert, Europe-wide. The market leader for mobile cranes, special transport, and assembly work.



STEIL KRANARBEITEN GMBH & CO. KG

Auf dem Adler 3, 54293 Trier
Tel.: +49 (0)651 146560
Fax: +49 (0)651 14656-50
E-Mail: info@steil-kranarbeiten.de
www.steil-kranarbeiten.de
Heavy things – moved easily! The right crane for almost any task, from mobile indoor cranes to loading cranes, truck-mounted cranes, up to 800 t lattice tower cranes.



Manufacturer and supplier advisory board



Expert consulting advisory board



Investors' advisory board



Expert consulting advisory board



Scientific advisory board



Operators' advisory board

Companies A – E

3Energy Unternehmensgruppe

Company profile p. 214
Planers & project developers p. 239

8.2 Group e. V.

Technical consultants p. 222

A

ABO Wind AG

Company profile p. 136
Service, maintenance & repair p. 230
Tech. & com. operational management p. 233
Planers & project developers p. 239

ADDINOL Lube Oil GmbH

Lubricants & lubrication systems p. 249

AeroBalancer – Meßsysteme Bergelt

Service, maintenance & repair p. 230

Aerones

Start-up p. 74

AIRWIN GmbH

Tech. & com. operational management p. 233

airXite GmbH

Technical consultants p. 222
Service, maintenance & repair p. 230
Transformers, converters
& power resistors p. 246

Akademie der Schraubverbindung (Barbarino & Kilp GmbH)

Education & training p. 220

AK Fehmarn GmbH & Co. KG

Dismantling and recycling p. 236

Akzo Nobel Hilden GmbH c/o International Farbenwerke GmbH

Rotor blades & rotor blade materials p. 247

alki TECHNIK GmbH

Tools & machine tools p. 250

AllCon Service & Dienstleistungs GmbH

Human resource services p. 236

AL-PRO GmbH & Co. KG

Wind resource evaluators p. 224

anemos

Gesellschaft fuer Umweltmeteorologie mbH
Wind resource evaluators p. 224

anemos-jacob GmbH

Wind resource evaluators p. 225
Measurement equipment
& measuring masts p. 245

August Friedberg GmbH

Bolts & fasteners p. 248

AURELO business IT-solutions GmbH

Software solutions p. 237

B

Bachmann electronic GmbH

Company profile p. 104
Controls, cables & switchgear cabinets p. 244

Bachmann Monitoring GmbH

Company profile p. 105
Condition monitoring systems p. 243

Balluff GmbH

Sensors p. 246

Basler Sachversicherungs AG

Insurance companies p. 228

BayWa r.e. Clean Energy Sourcing GmbH

Direct marketers p. 220

BBWind Projektberatungsgesellschaft mbH

Planers & project developers p. 239

BDO Oldenburg GmbH & Co. KG Wirtschaftsprüfungsgesellschaft

Company profile p. 137
Tax accountants p. 229

Becker Büttner Held

Lawyers p. 228

Beckhoff Automation GmbH & Co. KG

Company profile p. 107
Controls, cables & switchgear cabinets p. 244

BEE – German Renewable Energy Federation

Associations p. 235

BEKAWIND BAIER + KÖPPEL GmbH + CO. KG

Lubricants & lubrication systems p. 249

Bergmann Attorneys at Law

Lawyers p. 228

BET Büro für Energiewirtschaft und technische Planung GmbH

Consulting & business consulting p. 227

BGZ Fondsverwaltung GmbH

Tech. & com. operational management p. 233

BIL eG

Company profile p. 138
Service, maintenance & repair p. 230

Blacksafe GmbH

Occupational safety and health p. 237

blade care GmbH

Education & training p. 220
Service, maintenance & repair p. 230

Blanke Meier Evers

Rechtsanwälte in Partnerschaft mbB
Lawyers p. 228

BMR energy solutions GmbH

Planers & project developers p. 239

Boehm-Bezing & Cie. GmbH

Consulting & business consulting p. 227

BRAUER Maschinenteknik AG

Service, maintenance & repair p. 230
Gears p. 248

BWE – German Wind Energy Association

- Expert committees p. 211
- Events p. 213
- Corporate Publishing p. 215
Associations p. 235
Media & communication p. 236

Buss Energy Group GmbH

Service, maintenance & repair p. 231

BWT Bavinck Wind-Technik GmbH

Technical consultants p. 222

An overview of all categories
is inside the back cover page. ►

C		Deutsche Windtechnik Repowering GmbH & Co. KG		ELIN Motoren GmbH	
CENTA Antriebe Kirschey GmbH		Repowering	p. 242	Generators	p. 245
Coupling	p. 248				
Centrica Energy Trading GmbH		Deutsche Windtechnik Service GmbH & Co. KG		ELMEKO GmbH + Co. KG	
Company profile	p. 139	Service, maintenance & repair	p. 231	Cooling & climatisation	p. 244
Direct marketers	p. 220				
cms@wind GmbH		Deutsche Windtechnik Steuerung GmbH & Co. KG		ELPRESS GmbH	
Start-up	p. 76	Controls, cables & switchgear cabinets	p. 244	Company profile	p. 144
				Service, maintenance & repair	p. 231
Commerz Real Kapitalverwaltungsgesellschaft mbH		Deutsche Windtechnik Training Center Bremen		EMD Deutschland GbR	
Fund providers	p. 228	Safety training	p. 221	Company profile	p. 145
				Education & training	p. 221
Connected Wind Services Deutschland GmbH		Deutsche Windtechnik Training Center Viöl		Software solutions	p. 237
Company profile	p. 140	Education & training	p. 221		
Service, maintenance & repair	p. 231			EMIS Electrics GmbH	
		Deutsche Windtechnik Umspannwerke GmbH		Service, maintenance & repair	p. 231
Contrust Versicherungsmakler GmbH		Grids & grid connection	p. 238		
Insurance companies	p. 228			EnBW Energie Baden-Württemberg AG	
		Deutsche Windtechnik X-Service GmbH		Company profile	p. 146
cp.max Rotortechnik GmbH & Co. KG		Service, maintenance & repair	p. 231	Construction, operation, direct marketing	p. 221
Company profile	p. 141			Service, maintenance & repair	p. 231
Service, maintenance & repair	p. 231	dhp technology AG		Tech. & com. operational management	p. 234
		Start-up	p. 78	Planers & project developers	p. 239
				Repowering	p. 242
DAL Deutsche Anlagen-Leasing GmbH & Co. KG		Dirkshof / EED GmbH & Co. KG		ENERCON GmbH	
Banks, financial institutions & financial service providers	p. 226	Tech. & com. operational management	p. 234	Company profile	p. 93
				Innovative projects	p. 54
DEKRA Automobil GmbH – Industrie, Bau & Immobilien –		Dr. jur. Jörg Niedersberg		Wind turbines (> 100 kW)	p. 229
Technical consultants	p. 222	Lawyers	p. 229		
				energieprofile Ing.-büro GmbH & Co. KG	
Deutsche WindGuard		Dunoair Windpark Planung GmbH		Technical consultants	p. 223
Safety training	p. 221	Company profile	p. 143		
Technical consultants	p. 222	Planers & project developers	p. 239	Energiequelle GmbH	
Wind resource evaluators	p. 225			Company profile	p. 149
Consulting & business consulting	p. 227	DZ BANK AG		Planers & project developers	p. 239
Tech. & com. operational management	p. 233	Banks, financial institutions & financial service providers	p. 226		
Software solutions	p. 237			energy consult GmbH	
Offshore	p. 238	E		Company profile	p. 147
Measurement equipment & measuring masts	p. 245	EcofinConcept GmbH Renewable Energies		Tech. & com. operational management	p. 234
		Consulting & business consulting	p. 227		
Deutsche Windtechnik AG		EDF EN Deutschland GmbH		Energy Invest Consulting AG	
Company profile	p. 142	Planers & project developers	p. 239	Banks, financial institutions & financial service providers	p. 226
Service, maintenance & repair	p. 231				
		ee planung gmbh		energy & meteo systems GmbH	
Deutsche Windtechnik Offshore und Consulting GmbH		Planers & project developers	p. 239	Forecasting services providers	p. 220
Technical consultants	p. 222				
Service, maintenance & repair	p. 231	EEW Special Pipe Constructions GmbH		ENERTRAG AG	
		Foundations & footings	p. 246	Planers & project developers	p. 239
		EFFBE GmbH		ENERTRAG Service GmbH	
		Seals & vibration control	p. 250	Service, maintenance & repair	p. 231

Companies E – M

ENERTRAG WindStrom GmbH Tech. & com. operational management	p. 234				
EnerVest AG Planers & project developers	p. 239				
enervis energy advisors GmbH Consulting & business consulting	p. 227				
Engemann und Partner, Rechtsanwälte mbB Lawyers	p. 229				
ENGIE Deutschland Company profile Construction, operation, direct marketing	p. 151 p. 221				
eno energy Gruppe Company profile Wind turbines (> 100 kW)	p. 95 p. 229				
enosite GmbH Wind resource evaluators	p. 225				
enovation GmbH Development & construction	p. 236				
Enser Versicherungskontor GmbH Insurance companies	p. 228				
envia THERM GmbH Company profile Planers & project developers	p. 154 p. 239				
eolotec GmbH Bearings	p. 247				
Ernst Schad GmbH Gears	p. 248				
ESM Energie- u. Schwingungstechnik Mitsch GmbH Seals & vibration control	p. 250				
EWE ERNEUERBARE ENERGIEN GmbH Company profile Planers & project developers	p. 153 p. 240				
EWE ERNEUERBARE regional GmbH Planers & project developers	p. 240				
ExaMesh GmbH Start-up	p. 80				
expert office Dipl.-Ing. Harald Eden Technical consultants	p. 223				
		F			
		FAKON Wind GmbH Technical consultants	p. 223		
		FGH Technical consultants	p. 223		
		FLYTEG GmbH & Co. KG Service, maintenance & repair	p. 231		
		Framatome GmbH Company profile Service, maintenance & repair	p. 155 p. 232		
		G			
		GAIA mbH Company profile Service, maintenance & repair Planers & project developers	p. 156 p. 232 p. 240		
		GELSENWASSER AG Planers & project developers	p. 240		
		GEO-NET Umweltconsulting GmbH Wind resource evaluators	p. 225		
		GE Renewable Energy Wind turbines (> 100 kW)	p. 230		
		GEWI GmbH Direct marketers	p. 220		
		GfM Gesellschaft für Maschinendiagnose mbH Technical consultants Condition monitoring systems	p. 223 p. 243		
		Global Wind Energy Council (GWEC) Company profile Associations	p. 217 p. 235		
		GOM – Gesellschaft für optische Messtechnik GmbH Quality assurance	p. 230		
		GP JOULE GmbH Company profile Planers & project developers	p. 157 p. 240		
		GP JOULE Projects GmbH & Co. KG Tech. & com. operational management Sector Coupling	p. 234 p. 243		
		Gram & Juhl GmbH Company profile Condition monitoring systems	p. 108 p. 243		
		Green City AG Planers & project developers	p. 240		
		greenmatch AG Company profile Software solutions	p. 160 p. 237		
		Green Wind Group Company profile Tech. & com. operational management Repowering	p. 159 p. 234 p. 242		
		Grzib Elektrotechnik GmbH & Co. KG Company profile Service, maintenance & repair	p. 161 p. 232		
		GWU-Umwelttechnik GmbH Measurement equipment & measuring masts	p. 245		
		H			
		Hailo Wind Systems GmbH & Co. KG Access technology	p. 247		
		Hamburg Commercial Bank AG Banks, financial institutions & financial service providers	p. 226		
		Hamburg Messe und Congress GmbH Company profile Trade fairs & conferences for the wind energy industry	p. 163 p. 237		
		HAWART Sondermaschinenbau GmbH Company profile Rotor blades & rotor blade materials	p. 109 p. 247		
		HAWE Hydraulik SE Hydraulic components	p. 249		
		HD-Technic GmbH Technical consultants	p. 223		
		Helling GmbH Company profile Service, maintenance & repair	p. 164 p. 232		
		HELUKABEL GmbH Company profile Controls, cables & switchgear cabinets	p. 110 p. 244		
		HYTORC (Barbarino & Kilp GmbH) Tools & machine tools	p. 250		

An overview of all categories
is inside the back cover page. ►

I		K		Liebherr-MCCtec Rostock GmbH	
<hr/>		<hr/>		Crane companies, crane hire & special transport p. 251	
IDASWIND GmbH		Kaiserwetter Energy Asset Management GmbH		<hr/>	
Company profile	p. 165	Tech. & com. operational management	p. 234	Liebherr-Werk Biberach GmbH	
Technical consultants	p. 223	<hr/>		Crane companies, crane hire & special transport p. 251	
<hr/>		Koopmann Gruppe		<hr/>	
iE-Renewables Ingenieurbüro für Erneuerbare Energien – Dr. Ingo Ewald		Company profile	p. 167	Liebherr-Werk Ehingen GmbH	
Technical consultants	p. 223	Service, maintenance & repair	p. 232	Crane companies, crane hire & special transport p. 251	
Planers & project developers	p. 240	<hr/>		<hr/>	
<hr/>		KÖTTER Consulting Engineers GmbH & Co. KG		Liebherr-Werk Nenzing GmbH	
Ingenieurbüro Andresen		Technical consultants	p. 223	Crane companies, crane hire & special transport p. 251	
Technical consultants	p. 223	<hr/>		<hr/>	
<hr/>		Kreuzwind Schmieder & Schmidt GbR		Liebherr-Werk Nenzing GmbH	
Ingenieurbüro Kuntzsch GmbH		Dismantling and recycling	p. 236	Crane companies, crane hire & special transport p. 251	
Wind resource evaluators	p. 225	<hr/>		<hr/>	
<hr/>		KTW Umweltschutztechnik GmbH		M	
in.power GmbH		Service, maintenance & repair	p. 232	<hr/>	
Company profile	p. 166	Foundations & footings	p. 246	Max Bögl Wind AG	
Direct marketers	p. 220	<hr/>		Company profile p. 112	
<hr/>		Kübler Group		Towers p. 247	
in.power metering GmbH		Controls, cables & switchgear cabinets	p. 244	<hr/>	
Metering operations	p. 237	Sensors	p. 246	mayr Antriebstechnik	
<hr/>		<hr/>		Brakes p. 248	
Investitionsbank Schleswig-Holstein (IB.SH)		L		Coupling p. 248	
Banks, financial institutions & financial service providers	p. 226	<hr/>		<hr/>	
<hr/>		Landstrom GmbH & Co. KG		Megger GmbH	
Isoblock Schaltanlagen GmbH & Co. KG		Energy services	p. 222	Company profile p. 113	
Grids & grid connection	p. 238	<hr/>		Measurement equipment & measuring masts p. 245	
<hr/>		Landwind-Gruppe		<hr/>	
iTerra energy GmbH		Planers & project developers	p. 240	Menold Bezler Rechtsanwälte Steuerberater Wirtschaftsprüfer Partnerschaft mbB	
Planers & project developers	p. 240	<hr/>		Lawyers p. 229	
<hr/>		Landwirtschaftliche Rentenbank		<hr/>	
J		Banks, financial institutions & financial service providers	p. 226	menzio GmbH	
<hr/>		<hr/>		Wind resource evaluators p. 225	
Jade NaturEnergie GmbH & Co. KG		Lanthan GmbH & Co. KG		<hr/>	
Planers & project developers	p. 240	Company profile	p. 111	Messe Husum & Congress GmbH & Co. KG	
<hr/>		Innovative projects	p. 56	Company profile p. 173	
Jadewind GmbH & Co. KG		Aviation obstruction markers & lighting systems	p. 243	Trade fairs & conferences for the wind energy industry p. 237	
Technical consultants	p. 223	<hr/>		<hr/>	
<hr/>		LAP GmbH Laser Applikationen		METEK Meteorologische Messtechnik GmbH	
Jetstream Bosse Ing.-Büro für Windenergienutzung		Rotor blades & rotor blade materials	p. 247	Measurement equipment & measuring masts p. 245	
Technical consultants	p. 223	<hr/>		<hr/>	
<hr/>		The LIEBHERR Group		Meteorologisches Beratungsbüro, Dr. S. Theunert	
JUMO GmbH & Co. KG		Company profile	p. 171	Wind resource evaluators p. 225	
Sensors	p. 246	<hr/>		<hr/>	
<hr/>		Liebherr-Components AG		MLK-Gruppe	
juwi AG		Transformers, converters & power resistors	p. 246	Company profile p. 174	
Company profile	p. 168	Bearings	p. 247	Innovative projects p. 66	
Planers & project developers	p. 240	Gears	p. 248	Planers & project developers p. 240	
<hr/>		Hydraulic components	p. 249	<hr/>	
juwi Operations & Maintenance GmbH		<hr/>		<hr/>	
Company profile	p. 169	<hr/>		<hr/>	
Tech. & com. operational management	p. 234	<hr/>		<hr/>	

Companies M – T

M.O.E. GmbH Certification	p. 222	Nöiting GmbH – EXPERTEN FÜR VERTRIEBS- UNTERSTÜTZENDE KOMMUNIKATION Company profile	p. 178	p	
Moeller & Poeller Engineering GmbH (M.P.E.) Grids & grid connection	p. 238	Innovative projects	p. 60	Parasol GmbH & Co. KG Aviation obstruction markers & lighting systems	p. 243
Momentum Energy Deutschland GmbH Repowering	p. 242	Media & communication	p. 236	Pavana GmbH Wind resource evaluators	p. 225
Monsson Operation GmbH Company profile	p. 175	Nordex Group Company profile	p. 97	perma-tec GmbH & Co. KG Company profile	p. 117
Service, maintenance & repair	p. 232	Wind turbines (> 100 kW)	p. 230	Lubricants & lubrication systems	p. 249
morEnergy GmbH Start-up	p. 82	NORD/LB Company profile	p. 179	Peter Chr. Petersen GmbH & Co. KG Foundations & footings	p. 246
M.O.S.S. Computer Grafik Systeme GmbH Company profile	p. 172	Banks, financial institutions & financial service providers	p. 226	PHOENIX CONTACT Deutschland GmbH Company profile	p. 118
Software solutions	p. 237	Nordwest Assekuranzmakler GmbH & Co. KG Insurance companies	p. 228	Innovative projects	p. 62
MOWEA GmbH Start-up	p. 84	NOTUS energy Company profile	p. 180	Controls, cables & switchgear cabinets	p. 244
M-PT Matjeschk-PowerTools Innovative projects	p. 58	Planners & project developers	p. 241	plan-GIS GmbH Technical consultants	p. 224
Tools & machine tools	p. 250	NSK Deutschland GmbH Company profile	p. 116	Planners & project developers	p. 241
Multigear GmbH Company profile	p. 114	Bearings	p. 248	PLANKon Ing.-Büro für Windenergieprojekte Wind resource evaluators	p. 225
Gears	p. 248	N.T.E.S. GmbH Company profile	p. 176	Planners & project developers	p. 241
		Service, maintenance & repair	p. 232	Plarad – Maschinenfabrik Wagner GmbH & Co. KG Tools & machine tools	p. 251
				PNE AG Company profile	p. 181
N		O		Planners & project developers	p. 241
NATEN Betriebsführung GmbH Tech. & com. operational management	p. 234	OffTEC Base GmbH & Co. KG Safety training	p. 221	Polygonvatro GmbH – Windkraft Service – Service, maintenance & repair	p. 232
NATURSTROM AG Direct marketers	p. 220	Olmatic GmbH Start-up	p. 86	Power of Nature – Windenergie Wind resource evaluators	p. 225
NaturStromProjekte GmbH Planners & project developers	p. 241	Osborne Clarke Rechtsanwälte Steuerberater Partnerschaft mbB Lawyers	p. 229	Prowind GmbH Planners & project developers	p. 241
Netze BW GmbH – Division of services Company profile	p. 177	OSTWIND Erneuerbare Energien GmbH Planners & project developers	p. 241	Prysmian Kabel und Systeme GmbH Company profile	p. 119
Grids & grid connection	p. 238	OSTWIND management GmbH Tech. & com. operational management	p. 234	Controls, cables & switchgear cabinets	p. 244
new energy / neue energie Media & communication	p. 236				
NGC Transmission Europe GmbH Company profile	p. 115				
Gears	p. 249				

An overview of all categories
is inside the back cover page. ►

R		Rosendahl & Frank Windtechnik GmbH		Siemens Gamesa Renewable Energy GmbH & Co. KG	
R+V Allgemeine Versicherung AG		Company profile	p. 187	Company profile	p. 99
Company profile	p. 182	Technical consultants	p. 224	Wind turbines (> 100 kW)	p. 230
Insurance companies	p. 228				
		Rotor Control GmbH			
Ramboll		Service, maintenance & repair	p. 232	Sika Deutschland GmbH	
Company profile	p. 183			Offshore	p. 238
Wind resource evaluators	p. 225	RTS Wind AG		Surface technology	p. 250
Offshore	p. 238	Service, maintenance & repair	p. 233		
Planners & project developers	p. 241			SpanSet-Gruppe Deutschland	
		Rübsamen Windenergie GmbH		Company profile	p. 125
REA GmbH Management		Planners & project developers	p. 241	Tools & machine tools	p. 251
Planners & project developers	p. 241				
		RWE Renewables GmbH		Statkraft Markets GmbH	
RECASE Regenerative Energie GmbH		Company profile	p. 188	Company profile	p. 191
Company profile	p. 184	Construction, operation, direct marketing	p. 221	Direct marketers	p. 220
Development & construction	p. 236				
				STEGO Elektrotechnik GmbH	
reconcept. Green Global Investments		Sabowind GmbH		Company profile	p. 126
Banks, financial institutions		Planners & project developers	p. 241	Cooling & climatisation	p. 244
& financial service providers	p. 227	Repowering	p. 243		
				STEIL KRANARBEITEN GMBH & CO. KG	
Regenerative Energien Zernsee GmbH & Co. KG		Sabowind Service GmbH		Company profile	p. 194
Company profile	p. 185	Tech. & com. operational management	p. 234	Crane companies, crane hire	
Innovative projects	p. 66			& special transport	p. 251
Tech. & com. operational management	p. 234	SATELL Rechtsanwälte Steuerberater Reppich PartmbB			
		Company profile	p. 189	Sterr-Kölln & Partner mbB	
reko Windenergie-Analysen		Lawyers	p. 229	Company profile	p. 193
Wind resource evaluators	p. 225			Consulting & business consulting	p. 227
		SCADA International A/S			
REWITEC GmbH		Company profile	p. 190	Stromag GmbH	
Company profile	p. 120	Innovative projects	p. 68	Gears	p. 249
Innovative projects	p. 64	Software solutions	p. 237		
Lubricants & lubrication systems	p. 249			Sulzer & Schmid Laboratories AG	
		Schaeffler Monitoring Services GmbH		Service, maintenance & repair	p. 233
Rittal GmbH & Co. KG		Condition monitoring systems	p. 243		
Company profile	p. 121			Taylor Wessing	
Controls, cables & switchgear cabinets	p. 244	Schaeffler Technologies AG & Co. KG		Lawyers	p. 229
		Bearings	p. 248		
ROBUR Wind GmbH				TECHNO-PARTS GmbH	
Service, maintenance & repair	p. 232	Schmidbauer GmbH & Co. KG		Company profile	p. 127
		Crane companies, crane hire		Seals & vibration control	p. 250
Röchling Engineering Plastics SE & Co. KG		& special transport	p. 251		
Company profile	p. 122			THEOLIA Naturenergien GmbH	
Synthetic Components	p. 250	Schneider Consulting GmbH		Tech. & com. operational management	p. 235
		Planners & project developers	p. 241		
RolaWind GmbH				TOP seven GmbH & Co.KG	
Technical consultants	p. 224	Schraubenwerk Zerbst GmbH		Company profile	p. 195
		Company profile	p. 123	Innovative projects	p. 70
RoSch Industrieservice GmbH		Bolts & fasteners	p. 248	Service, maintenance & repair	p. 233
Company profile	p. 186				
Service, maintenance & repair	p. 232	SHE Solution Bergmann GmbH & Co. KG			
		Safety training	p. 221		
		Safety features & equipment	p. 245		

Companies T – W

TOTAL Deutschland GmbH		Volta Windkraft GmbH		Wind Multiplikator GmbH	
Company profile	p. 129	Tech. & com. operational management	p. 235	Consulting & business consulting	p. 227
Lubricants & lubrication systems	p. 249				
		VSF Group		Wind Multiplikator QHSE GmbH	
Tractebel Engineering GmbH		Company profile	p. 203	Consulting & business consulting	p. 227
Wind resource evaluators	p. 226	Planers & project developers	p. 242		
Consulting & business consulting	p. 227			WindStrom Erneuerbare Energien GmbH & Co. KG	
Offshore	p. 238	VSF Service GmbH		Planers & project developers	p. 242
Planers & project developers	p. 242	Tech. & com. operational management	p. 235		
				windtest grevenbroich gmbh	
TRICON Assets GmbH		VSF Technik GmbH		Technical consultants	p. 224
Software solutions	p. 237	Service, maintenance & repair	p. 233		
				Windwärts Energie GmbH	
Triflex GmbH & Co. KG		W		Company profile	p. 205
Service, maintenance & repair	p. 233			Tech. & com. operational management	p. 235
		WEB Andresen GmbH		Planers & project developers	p. 242
TÜV NORD EnSys GmbH & Co. KG		Tech. & com. operational management	p. 235	Repowering	p. 243
Company profile	p. 196				
Wind resource evaluators	p. 226	Weidmüller Group		Winergy	
		Company profile	p. 130	Company profile	p. 133
TÜV Rheinland Industrie Service GmbH		Condition monitoring systems	p. 243	Service, maintenance & repair	p. 233
Technical consultants	p. 224			Gears	p. 249
		Weitkowitz GmbH		Wittgenstein Wind	
TÜV SÜD Industrie Service GmbH		Company profile	p. 131	Tech. & com. operational management	p. 235
Certification	p. 222	Energy & data transmission	p. 245		
Technical consultants	p. 224			WKL Rechtsanwälte (Witter & Kollegen Legal Partnerschaft von Rechtsanwälten mbB)	
Wind resource evaluators	p. 226	WestWind Projektierungs GmbH & Co. KG		Lawyers	p. 229
Offshore	p. 238	Planers & project developers	p. 242		
				WKN GmbH	
U		WestWind Service GmbH & Co. KG		Company profile	p. 206
		Tech. & com. operational management	p. 235	Planers & project developers	p. 242
UKA – Umweltgerechte Kraftanlagen GmbH & Co. KG					
Company profile	p. 199	Wieland Electric GmbH		Wölfel Wind Systems GmbH	
Planers & project developers	p. 242	Company profile	p. 132	Company profile	p. 207
		Light fittings & emergency light fittings	p. 245	Technical consultants	p. 224
				Condition monitoring systems	p. 244
V		WIND-certification GmbH		Seals & vibration control	p. 250
		Certification	p. 222		
VENSYS Energy AG				wpd windmanager GmbH & Co. KG	
Company profile	p. 101	windcomp GmbH		Company profile	p. 209
Wind turbines (> 100 kW)	p. 230	Company profile	p. 204	Tech. & com. operational management	p. 235
		Service, maintenance & repair	p. 233		
Ventur GmbH				WT Energiesysteme GmbH	
Towers	p. 247	WIND-consult GmbH		Grids & grid connection	p. 238
		Technical consultants	p. 224		
VERBUND		Wind resource evaluators	p. 226	WTS – Wind-Tuning-Systems GmbH	
Company profile	p. 201	Offshore	p. 238	Start-up	p. 88
Direct marketers	p. 220				
		windexperts Prüfgesellschaft mbH		WTSH – Business Development and Technology Transfer Corporation of Schleswig-Holstein GmbH	
Volkswind GmbH		Technical consultants	p. 224	Institutions	p. 236
Company profile	p. 202				
Planers & project developers	p. 242	WindGuard Certification			
		Certification	p. 222		

Picture credits

Photos and graphics in the company profiles were provided by the respective companies.

Cover photo: Barbara Heinz / Vensys

Imprint

BWE Industry Report
Wind Industry in Germany

Publisher:

Legally responsible for content:
Bundesverband WindEnergie e. V. (BWE)
represented by the President

Concept: Thorsten Paulsen, Benjamin Gruhn, Marie Kunath

Editorial team:

neue energie – das magazin für klimaschutz
und erneuerbare energien. Autor: Michael Hahn

10th edition, December 2020
Print run, German: 13,000 copies
Print run, English: 2,000 copies

Order address:

Bundesverband WindEnergie e.V. (BWE)
EUREF-Campus – Haus 16
10829 Berlin, Germany
Tel.: +49 (0)30 212341-210
Fax: +49 (0)30 212341-410
bestellung@wind-energie.de

Sector portal:

www.windindustry-in-germany.com

Advertising / Company profiles:

Bundesverband WindEnergie e. V.
Tel.: +49 (0)30 212341-210
Klaus Barkeling (k.barkeling@wind-energie.de; Tel: -177)
Nikos Fucicis (n.fucicis@wind-energie.de; Tel.: -178)

Design / Layout:

Mike Müller Visuelle Kommunikation
mail@muellerstudio.de
www.muellerstudio.de

Translation:

Kira Gee
kira.gee@gmx.de
www.echoo.de

Printing:

Müller Ditzten AG
Hoebelstr. 19
27572 Bremerhaven, Germany

Category overview

Here we list all companies by the services and products they offer.
An alphabetical list of companies is on page 252.

Direct marketing 	Operation & service 	Suppliers of electrical and electronic components 
Direct marketers p. 220	Quality assurance p. 230	Aviation obstruction markers & lighting systems p. 243
Forecasting services providers p. 220	Service, maintenance & repair p. 230	Condition monitoring systems p. 243
	Technical & commercial operational management p. 233	Controls, cables & switchgear cabinets p. 244
		Cooling & climatisation p. 244
		Energy & data transmission p. 245
		Generators p. 245
		Energy & data transmission p. 245
		Measurement equipment & measuring masts p. 245
		Safety features & equipment p. 245
		Sensors p. 246
		Transformers, converters & power resistors p. 246
Education & training 	Organisations & public institutions 	Suppliers of large components 
Education & training p. 220	Associations p. 235	Foundations & footings p. 246
Safety training p. 221	Institutions p. 236	Rotor blades & rotor blade materials p. 247
		Towers p. 247
Energy services 	Other services 	Suppliers of mechanical components 
Construction, operation, direct marketing p. 221	Development & construction p. 236	Access technology p. 247
Energy services p. 222	Dismantling and recycling p. 236	Bearings p. 247
	Human resource services p. 236	Bolts & fasteners p. 248
	Media & communication p. 236	Brakes p. 248
	Metering operations p. 237	Coupling p. 248
	Occupational safety and health p. 237	Gears p. 248
	Software solutions p. 237	Hydraulic components p. 249
	Trade fairs & conferences for the wind energy industry p. 237	Lubricants & lubrication systems p. 249
		Seals & vibration control p. 250
		Surface technology p. 250
		Synthetic components p. 250
		Tools & machine tools p. 250
Inspection bodies/ measurement institutes 	Planning 	Transport & logistics 
Certification p. 222	Grids & grid connection p. 238	Crane companies, crane hire & special transport p. 251
Technical consultants p. 222	Offshore p. 238	
Wind resource evaluators p. 224	Planners & project developers p. 239	
	Repowering p. 242	
Finance & law 	Sector Coupling 	
Banks, financial institutions & financial service providers p. 226	Sector Coupling p. 243	
Consulting & business consulting p. 227		
Fund providers p. 228		
Insurance companies p. 228		
Lawyers p. 228		
Tax accountants p. 229		
Manufacturers 		
Wind turbines (> 100 kW) p. 229		



www.windindustry-in-germany.com