



Wind Industry in Germany

ECONOMIC REPORT: An overview of the German wind industry

COMPANIES: Leading companies in the sector present their products and services

INDUSTRY DIRECTORY: Around 400 addresses – easy access to the right contact

2020

New!

**Innovative Projects
and Start-ups**



INTERNATIONAL



Wind Industry in Germany 2020

BWE INDUSTRY REPORT



Editorial



Dear Readers,

The international wind energy markets are developing dynamically both onshore and offshore. More and more countries are opting for CO₂-free energy production and wind energy as a mass energy carrier. As leaders in technology with efficient and high-performance power plants, German companies are at the forefront of this international trend, even when it comes to successful participation in international tenders. This success is based on a stable foundation in Germany's domestic market. New innovations are conceived, developed and made ready for the market here. This requires a highly competitive and high-volume market. This was the case between 2014 and 2017, as onshore wind energy capacity increased by 4,600 MW on average. However, in 2018, there was a slump: onshore capacity only increased by 2,402 MW. This was due to a false start in Germany's tender system and slow approvals. There is a further threat of a market downturn in 2019, which puts our high-performance branch of industry under massive pressure across the value chain.

The underlying global framework is actually excellent, and it should provide a good outlook for our industry: In 2023, Germany's energy production will function without nuclear power. The federal government has set the renewable energy target to 65 percent by 2030. The German Commission on Growth, Structural Change and Employment has decided to phase out coal. We should be able to successfully replace lignite in the next 10 years. More and more mid-sized German companies as well as German industrial companies want to achieve continuous CO₂-free production through their own investments. The federal government is discussing a green gas and hydrogen strategy. The new president of the European Commission promises a "Green Deal" for Europe. The energy transition is picking up speed again.

Wind energy is one of the global key technologies of the future. Therefore, it must be placed at the center of forward-looking industrial and economic strategies. Germany has a great opportunity to advance the energy transition as a driver of innovation, growth and employment, and, in doing so, further determine the pace of technological development in the growing international markets. The companies brought together in the German Wind Energy Association (Bundesverband WindEnergie) are ready to implement technically viable power plant concepts for modern sector coupling solutions through well-engineered products. We want to continue to assume responsibility by organising the direct supply to industry, businesses, commercial trading, the craft sector and municipalities ourselves, as well as co-operating with the public to plan the expansions necessary for this. To this end, politicians should not be afraid to open doors that have remained closed until now.

Yours,

H. Albers

Hermann Albers, President of the
German Wind Energy Association

Contents



Economic report

THE GERMAN MARKET

Sharp drop in new turbines 10
 New construction of onshore wind turbines declined sharply in 2018, and even fewer turbines could be installed in 2019. There were also fewer offshore installations.

GLOBAL MARKET

Stable growth offers opportunities 13
 Although slightly fewer wind turbines were installed worldwide in 2018, stable growth is expected over the next few years. This offers opportunities: more and more German companies also operate internationally. In Europe, however, expansion declined more sharply.

JOBS

Job cuts continue 16
 An industry under pressure: the wind industry in Germany is in financial trouble, resulting in redundancies. Companies lack reliable framework conditions.

OFFSHORE

Falling growth and stable outlook 20
 The expansion of offshore wind energy declined last year. In order to meet the climate targets of the German Federal Government, the industry is demanding additional capacities. The number of installations also fell worldwide. Most of the turbines were installed in China for the first time.

TECHNOLOGY

Concepts for the price war 22
 The cost pressure in the wind energy sector is forcing turbine manufacturers to bring ever more efficient and larger wind turbines onto the market. Engineers react with technical innovations and cost-optimised designs.

COSTS AND INVESTMENTS

Wind energy is becoming increasingly affordable 24
 The costs of wind energy are falling everywhere, and renewable energies are now the most cost-effective form of electricity generation in many places. Hundreds of billions of dollars are invested in this technology worldwide. However, Germany has lost some of its attractiveness.

CONTINUED OPERATION

Not yet ready for the scrap heap, even after 20 years 26
 In a few years, the first wind turbines will no longer be eligible for EEG subsidies. In view of the electricity exchange prices, continued operation is not worthwhile for many operators. However, this could change in the future. In addition, companies that are taking over old turbines have stepped onto the scene.

REVENUE MODELS WITHOUT EEG

PPAs also gaining ground in Germany ... 28
 With long-term supply contracts, known as PPAs, renewable energy producers can make themselves independent of state subsidies. In Germany, too, markets are evolving, but there is room for much more, say experts.

SECTOR COUPLING

Renewable energies: more than just electricity 30
 For the energy transition to be a success, renewables must replace fossil fuels not just in the area of electricity generation. The needs of the other sectors must also be met with green energy. There is still a lack of suitable framework conditions.

Sustainability – many small steps towards the larger goal 36



New in this edition: Start-ups and innovative projects

The German wind industry has to live up to an excellent reputation. We are therefore giving more space to those whose **innovative power** and **new business models** are driving the entire sector.

?
Briefly asked.



The sector is driven by its actors. We have asked entrepreneurs of the German Wind Industry about their most important innovations, strategies and markets. Read their answers on pages 12, 14, 18 and 34.

Companies

NEW! Companies with innovative projects 40

These pages are dedicated to companies whose new products, processes or methods ensure the continued development of the wind industry.

NEW! Start-ups 58

Start-ups are entering the market with new ideas. A selection is presented on these pages. Be inspired by their innovative power.

Manufacturers 70

German manufacturers have a high share of the world market, reaching an export rate of 60 to 70 percent. The technology and efficiency of their turbines set standards and are sought-after globally.

Suppliers 84

Manufacturers of wind turbines from all over the world buy systems and components in Germany. Years of experience of the operational side together with specific research and development projects to reduce manufacturing and operating costs and prolong service life are much in demand everywhere.

Service and logistics 124

Planning, finance, transport, construction and marketing. The fields of planning and operation of wind turbines are a continuous growth market in Germany.

Publisher 194

The German Wind Energy Association is the voice of the German wind energy sector. It publishes "Wind Industry in Germany", brings together companies in its various committees, and uses its events to pass on technical knowledge to experts and newcomers alike.

Industry directory 202

Almost 400 addresses of leading companies in the wind industry.

Companies A-Z 240

Picture credits 248
Imprint 248

Category overview 251

An overview of all categories is inside the back cover page.

ECONOMIC REPORT:

The German Wind Industry

Germany currently has about 30,000 wind turbines on its territory, corresponding to an installed output of almost 60,000 MW. Around 135,000 people are employed in the sector.



Photo: Max Bögl Wind AG, Matthias Rebel



Sharp drop in new turbines

New construction of onshore wind turbines declined sharply in 2018, and even fewer turbines could be installed in 2019. There were also fewer offshore installations.

The expansion of onshore wind energy saw a massive decline in Germany in 2018. According to figures from the German Wind Energy Association (BWE) and the VDMA Power Systems mechanical engineering association, a total of 743 turbines with a total rated capacity of 2,402 megawatts (MW) were erected. This represents a minus of 55 percent compared to the record year 2017 (1,792 new turbines with 5,333 MW).

205 turbines were dismantled and 111 installed as part of a repowering process in which old turbines are replaced with new, more powerful ones. At the end of 2018, the blades of a total of 29,213 wind turbines were turning onshore in Germany, with a rated capacity of 52,931 MW. In a comparison of the federal states, Lower Saxony was once

again in the lead with 206 new turbines (718 MW), followed by North Rhine-Westphalia with 106 turbines (331 MW) and Brandenburg with 91 turbines (289 MW). In the south of Germany 121 new turbines were built, most of them in Rhineland-Palatinate (66) and Baden-Württemberg (26), followed by Saarland (21) and Bavaria (8).

Offshore, 136 new wind turbines with a rated capacity of 969 MW were connected to the grid last year. To provide a sense of scale: in 2017, it was just 222 turbines with 1,250 MW. At the end of 2018, a total of 1,305 wind turbines with a total rated capacity of 6,382 MW were in operation. In addition, 46 turbines (276 MW) had already been installed but not yet connected to the grid. A further 124 foundations were prepared for turbine installation.



WIND TURBINES IN GERMANY

Wind energy expansion figures (Onshore, 2000–2018)

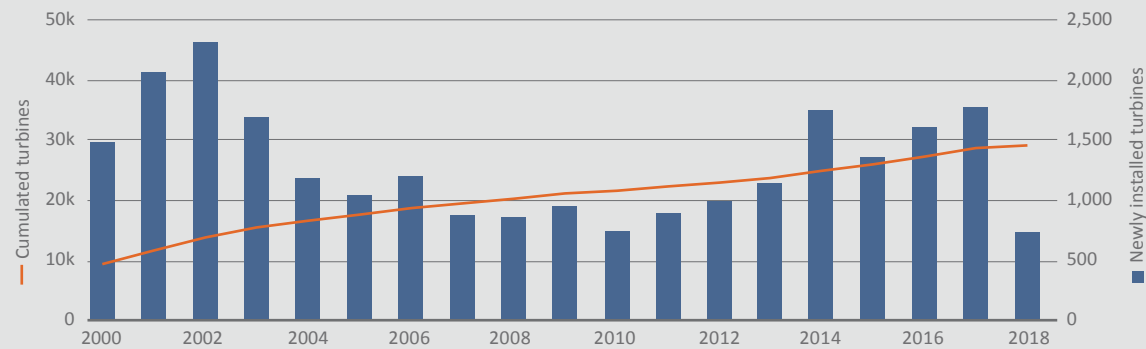

By the end of 2018, the total number of onshore wind turbines standing in Germany was 29,213. Source: WindGuard GmbH

More electricity from wind energy

All onshore and offshore wind turbines produced 111 terawatt hours (TWh) of electricity in 2018, an increase of 5.5 percent over 2017 (calculated by the Fraunhofer Institute for Solar Energy Systems). Divided across the individual types of generation, this means that wind turbines supplied 87.4 TWh of clean electricity onshore and 18.8 TWh offshore. All renewable energies combined reached a value of 219 TWh, 4 percent more than in 2017. According to analyses by the Centre for Solar Energy and Hydrogen Research Baden-Württemberg (ZSW) and

the German Association of Energy and Water Industries (BDEW), this covered 35 percent of gross electricity consumption in Germany, 2 percent more than in 2017. In the first half of 2019, the share was even 44 percent.

In 2019, the increase is expected to decline further. As reported by the Onshore Wind Energy Agency (FA Wind), only 41 wind turbines with a total rated capacity of 134 MW were erected in the first three months of the new year. “This means that the newly installed turbine capacity is almost 90 percent below the level of each of the first quarters of the

previous three years”, explains FA Wind. “The drastic slump in wind energy expansion in the first quarter of 2019 is the low point of a long-term and politically administered development, which was caused by the capping of the volume of new installations in the tendering procedure and by mismanagement in the Renewable Energy Sources Act (EEG 2017). Politicians are called upon to clarify how the lost quantities on the expansion path can be absorbed by 2030”, says Hermann Albers, President of the German Wind Energy Association.



Photo: Max Bögl Wind AG, Johnstown Media

The sector is driven by its actors. We asked decision-makers for their views.

Question #1: “Which actors have a particular responsibility for promoting the German wind industry?”



“For the industry to develop successfully, more capacity is needed within the relevant authorities to deal with approval procedures, as well as price adjustments on the part of wind turbine manufacturers.”

DR. ANDREAS MÖLLER, Manager,
ABICON GmbH



“The expansion of wind energy in Germany still requires political support in the form of reliable regulation in order to achieve the targets defined in law. The wind sector must continue to lobby towards this end, as well as to increase acceptance for wind power.”

DIRK GÜSEWELL, Head of Portfolio Development at
EnBW Energie Baden-Württemberg AG



“The supply industry makes a major contribution to increasing the efficiency of operating wind turbines, through offering intelligent solutions such as condition monitoring alongside consumption and energy balancing.”

MARC LIEBERT, Global Segment Manager,
Weidmüller GmbH & Co. KG



“Wind energy projects are becoming ever more complex. Success depends on local acceptance which is a challenge for all actors. This is why we connect customers and business partners and enable citizen participation.”

JÖRG-UWE FISCHER, Head of the Renewable Energies
Competence Centre of DKB and chairman of the Wind
Energy Association’s finance advisory council



“In the future, only those will be successful in the industry who can respond flexibly to the needs of all market participants. Structurally, eno energy is ideally positioned to also offer cross-sectoral solutions.”

STEFAN BOCKHOLT, Manager
of eno energy Group



“We – industry and politics – have to work together to increase acceptance and strengthen the financial income of municipalities. New priority areas for wind must be identified where there has previously been little wind energy.”

MEINRAD WAGENSCHWANZ, Vice President
Renewable Energies Germany, juwi AG



“The onus is on politicians to resolve existing blockages with respect to approvals, created by overly long approval processes and legal obstacles. We are a strong sector that is able and willing to promote the energy transition.”

BJÖRN WENZLAFF, Manager,
Windwärts Energie GmbH

GLOBAL MARKET

Stable growth offers opportunities

Although slightly fewer wind turbines were installed worldwide in 2018, stable growth is expected over the next few years. This offers opportunities: more and more German companies also operate internationally. In Europe, however, expansion declined more sharply.

Wind energy is on the road to success worldwide. According to the international umbrella organization Global Wind Energy Council (GWEC), turbines with a rated capacity of 51.3 gigawatts (GW) were installed in 2018, of which 46.8 GW were onshore and 4.5 GW offshore. Although this corresponds to a slight minus of 4 percent compared to 2017, it was nevertheless a “strong year” for the global wind industry, writes the association in its Global Wind Report.

The volume installed around the world thus rises to 591 GW. According to the GWEC Report, the largest onshore markets were China and the USA, where wind capacities of 21.2 GW and 7.6 GW respectively were installed. Despite a market slump (p. 10), Germany still ranks third with 2.4 GW, followed by India (2.2 GW) and Brazil (1.9 GW). A total of 4.8 GW was installed in the growth markets of Africa, the Middle East, Latin America and Southeast Asia, making up almost 10 percent of all new installations. The authors of the analysis also expect continuous growth beyond 2018. By 2023, more than 55 GW of onshore and offshore wind will be commissioned annually. According to the GWEC, the development in Asia, Europe and North America will continue with stable volumes. Plus, “growth will come from the expansion of wind energy markets in Africa, the Middle East, Latin America and Southeast Asia.”

Construction of Johnston wind farm in Rhode Island, USA. Photo: Ulrich Mertens



Europe: wind energy will be the most important source of energy by 2030 at the latest

According to WindEurope, wind power capacity added across Europe was 11.7 GW (9 GW onshore and 2.65 GW offshore) – a decline of 32 percent compared with 2017 and the lowest figure since 2008. In addition to Germany, the United Kingdom was also responsible for the slump. Nevertheless, the two countries, along with France and Sweden, are among the main expansion drivers. Together, they account for 65 percent of new installations. “With a total rated capacity of 178.8 GW installed, wind energy remains the second largest electricity generation capacity in the EU and is expected to overtake natural gas plants in 2019”, WindEurope predicts. Findings of the umbrella association indicate that wind energy covered 14 percent of Europe’s electricity requirements. According to the “World Energy Outlook 2018” of the International Energy Agency (IEA), electricity from wind will be the most important source of energy in Europe before 2030.

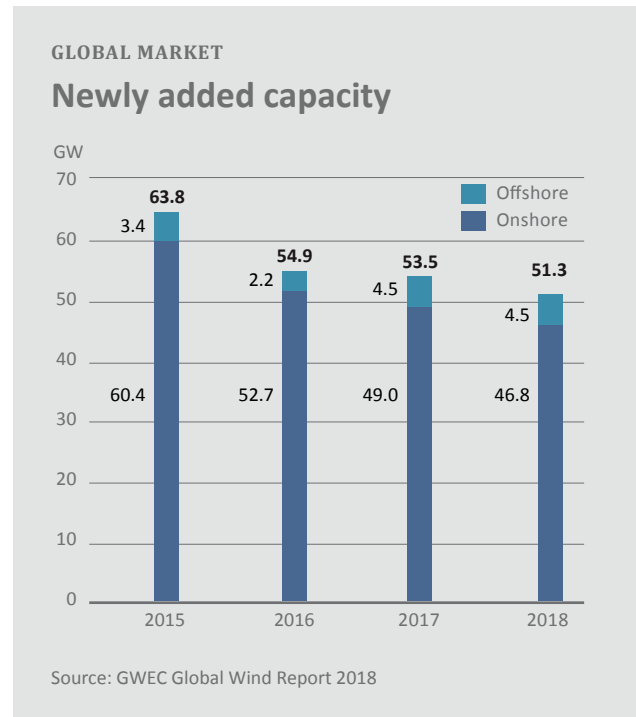

Question #2: “In which foreign markets is your company particularly active and why?”



“We are constantly expanding our foreign activities, recently to the US and Taiwan, often hand in hand with our customers. Always taking into account economic significance and qualitative feasibility.”

MATTHIAS BRANDT,
Board of Deutsche Windtechnik



“Since 2010 we have been manufacturing in China directly and locally for our wind energy customers, as over the past years the nominal capacity of wind energy plants has constantly increased there.”

CLAUDIUS HIRSCH, Manager, Interhydraulik
Gesellschaft für Hydraulik-Komponenten mbH



“We have excellent know-how both domestically and in the European markets, as well as in America, Australia and Asia. We support our customers with tailored financing solutions for their international projects in renewable energy and infrastructure projects.”

HEIKO LUDWIG, Global Head Structured Finance
NORD/LB



“France and Mexico – two large and very different countries with high electricity needs or a lot of catching up to do in terms of renewable energies.”

HEINER RÖGER, Manager
NOTUS energy



“France is a core market for VSB. We have built up divisions for project development for wind and PV there, as well as operational management. We are also successful as a service provider.”

MARKO LIESKE, Manager,
VSB Holding GmbH

The high level of expansion worldwide represents a great opportunity for German wind turbine manufacturers. Due to the stagnating order situation in Germany, they will have to focus more on international markets. And they have done so successfully: Nordex and Senvion, for example, reported rising incoming orders from non-European markets in 2018. Enercon also announced its intention to focus more on countries outside Germany in future. According to a survey by the renewable energies cluster Erneuerbare Energien Hamburg, almost every second (48 percent) onshore company in the Hamburg metropolitan region expects a good or very good international situation. Offshore, as many as 80 percent of the companies surveyed see “good” or “outstanding” prospects abroad.



Jeffreys Bay wind farm, South Africa, with 60 SiemensGamesa wind turbines. Photo: Paul-Langrock.de



“The international market is becoming increasingly important. We now look after a total of 4,053 MW, 1,133 of which are international in Belgium, Finland, France, Canada, Croatia, Poland and Taiwan.”

NILS BRÜMMER, Executive Director,
wpd windmanager GmbH & Co. KG



“Asian Wind OEMs ask for new Röchling solutions especially in China which is the new business opportunity for global wind. Röchling expects new demands from customers in Asia for on- and offshore wind.”

DAN MORITZ, Industry Manager Wind Power,
Röchling Industrial



“RES is represented in ten countries. This global market presence gives us more clout and our clients benefit from strong partnerships, exchange of experience and our network.”

DOMINIQUE GUILLOU, CEO,
RES Deutschland GmbH



“In Norway, Sweden and Finland. Because they are Ramboll’s home markets, where we can combine deep local knowledge with strong engineering teams to deliver outstanding expertise to our customers.”

JOACHIM BINOTSCH, Business Development Manager
Onshore Wind, Ramboll



“With local production facilities in China, India and the USA, Rittal serves the Asian and American focus markets of wind energy.”

FRANZISKA HAIN, Vertical Market Manager Energy,
Rittal GmbH & Co. KG

Job cuts continue

An industry under pressure: the wind industry in Germany is in financial trouble, resulting in redundancies. Companies lack reliable framework conditions.

The statement that the wind industry creates jobs has been an accepted fact for quite some time. According to a study commissioned by the Federal Ministry for Economic Affairs and Energy, 160,200 people were employed in the wind industry, the strongest single renewable energy sector, in 2016. Of these, 133,000 worked in the onshore sector and 27,200 in the offshore sector. This means that the number of employees in the wind energy industry has risen by more than 50,000 since 2011.

Lately, however, this creator of jobs has run into serious problems. Due to the changeover of the remuneration to a tendering system in conjunction with quantity limits and controversial exemptions, the up-and-coming industry has fallen upon hard times (p. 10). Employees are also particularly affected. In 2018, turbine manufacturers Enercon and Vestas announced redundancies. At the German market leader Enercon, more than 800 employees of supplier companies lost their jobs by the end of 2018. Vestas announced its intention to part with

400 employees, most of them in Denmark and Germany. "Due to the tense market situation in Germany, it is no longer possible to utilise the capacity of our suppliers to the necessary extent. A reduction in supplier contracts is therefore inevitable," said Enercon's Managing Director Simon-Hermann Wobben, justifying the painful step. Vestas explained that the company wants to grow predominantly outside Europe in future. The two manufacturers are only the latest examples: previously, Senvion, Nordex and Siemens Gamesa already responded to the grow-



Photo:
Siemens Gamesa
Renewable Energy

Production of nacelles at the Nordex DMR plant in Rostock
Photo: Ove Arscholl



ing pressure in the industry in terms of cost and competition as well as the decline in orders in the European market by cutting jobs.

Further redundancies expected

According to a survey conducted among works councils in July 2018 on behalf of the IG-Metall Küste trade union, more than 2,000 jobs have already been cut in the German wind industry since the beginning of 2017. In total, companies had announced that they would lay off between 3,500 and 4,000 people. In addition, 65 percent of the companies expect a negative market development, and 40 percent expect further redundancies. Industry representatives believe that the German government’s energy policy is primarily responsible for the situation.

In addition to the changeover to the tendering system including the expansion caps at 2,800 to 2,900 megawatts per year, the exemptions for citizens’ energy projects – which have since been withdrawn – proved problematic. In 2017, no permits under the Federal Immission Control Act were required for the projects to participate in auctions. As a result, it remains unclear whether the wind turbines will actually be built – which will have a detrimental impact on the manufacturers’ order books.

“The Federal Government shares responsibility for the current job cuts as a result of the substantial reduction in expansion”, explains Hermann Albers, President of the German Wind Energy Association. What is therefore needed is “a reliable time and quantity concept for further expansion until 2030. This is the only way for the companies in our industry to return to viable cost, supply and personnel planning in view of planning periods of three to five years per wind turbine”.

GERMANY

Employees in the wind industry

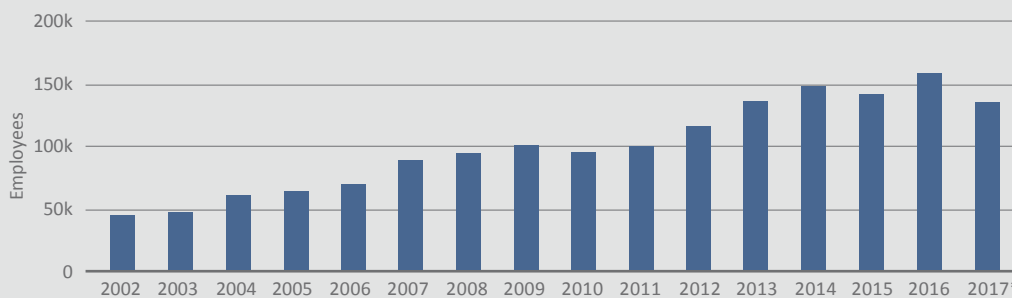

An important employer irrespective of job losses: More than 100,000 people are employed in the wind energy sector.

Source: Institute of Economic Structures Research on behalf of the Federal Ministry of Economics and Technology (BWi) (2016) and the BWE, VDMA Power Systems and the Offshore Wind Industry Alliance (up to 2015).

* (From a response by the German government which draws i.a. on estimates by the German Institute for Economic Research)

Question #3: “What has been your most important strategic decision within the last two years?”



“In the past, our well-being depended solely on wind energy development in Germany. Today we work in 16 countries, have expanded our O&M services, and develop solar parks to balance out fluctuations.”

ALEXANDER KOFFKA, General Management,
ABO Wind AG

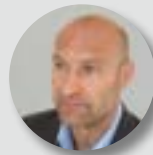

“To develop a software plug-in for our CMS to measuring blade unbalances. We were the first to market this and measure even small unbalances in kgm.”

HOLGER FRITSCH, General Management,
Bachmann Monitoring GmbH

“The uncompromising direction of our global organisation to support the strategies of our OEM customers to help them be the preferred turbine supplier to their customers”

ANDREAS SCHUBERT, Global Key Account Manager,
Wind Energy/Renewable Market Manager,
DEUBLIN GmbH



“Due to our strategic positioning we can offer our entire range of services regarding grid code compliance to manufacturers and project developers from a single source.”

BERNHARD SCHOWE-VON DER BRELLIE,
Manager of FGH GmbH and FGH Zertifizierungs-
gesellschaft mbH



“Gram & Juhl has focused on developing new software related to cyber security and machine learning as this will be the main topics in the future of the wind industry.”

ZABIHULLAH ALEFI, COO GJDE, Head of Monitoring,
Gram & Juhl GmbH



“Thanks to our latest product, GM Asset Controlling, greenmatch’s product range is now tailored to map the entire life cycle of a project financially.”

MORIS ISIK, Co-CEO, Founder
greenmatch AG



“The implementation of a CMMS system for professional controlling inspection dates as well as sustainably managing defects detected during inspection or service assignments.”

CHRISTIAN ARNOLD, Management,
juwi Operations & Maintenance GmbH



“We entered the offshore segment with a proprietary maintenance system for large-scale projects and, at the same time, developed a complex, independent 24/7 control center, which now looks after onshore and offshore projects alike.”

MANUEL LASSE, Managing Director
Green Wind



“The partnership with ROBUR opens up new options for our customers – whether through additional services, investments, or expansion of the international business.”

MAIK SCHLAPMANN, Founder and Manager of
ROSCH Industrieservice GmbH



“Integrated operational management and maintenance by a service provider forms the basis for economically successful operation of wind farms.”

MARTIN FRANGEN, Manager,
Koopmann Group



“An important decision was to bring know-how and decades of experience in sealing technology for large and heavy machine construction into the challenging growth market of wind energy.”

DIETMAR WOYCINIUK, Manager,
TECHNO-PARTS GmbH



“PNE is one of the most experienced developers of wind farms. Now we have developed into a “clean energy solutions provider”. In addition to wind, in the future, we will develop photovoltaics, storage, services.”

MARKUS LESSER, CEO,
PNE AG



“Having enhanced our power generation portfolio by driving forward the expansion of our 24/7 monitoring capacity over the past few years, both in technical and staffing terms, this has now become a central building block of our technical operations management service.”

FLORIAN DOMMEL, Operations Department Manager,
Pfalzwerke Aktiengesellschaft



“The key decision was to establish QV LUX at a time when on-demand night lighting approved by the civil aviation authority was being made a legal requirement. That’s what I call perfect timing!”

PETER-HEINRICH BOYSEN, CEO,
QV LUX GmbH

Falling growth and stable outlook

The expansion of offshore wind energy declined last year. In order to meet the climate targets of the German Federal Government, the industry is demanding additional capacities. The number of installations also fell worldwide. Most of the turbines were installed in China for the first time.



The 60 turbines of E.On's Arkona offshore wind farm in the German Baltic generate a total output of 384 MW. Photo: Paul-Langrock.de

Offshore wind energy is becoming an increasingly important pillar of energy supply. In Germany alone, 24,500 people work in this field. However, only 136 new wind turbines with an output of 969 megawatts (MW) were connected to the grid in 2018, as determined by Deutsche WindGuard on behalf of the offshore industry organisations. To provide a sense of scale: in 2017 there were 222 new turbines with an output of 1,250 MW. A further 276 MW had been installed by the end of 2018, but not yet been connected to the grid. In addition, 124 additional foundations have already been built. The total offshore capacity thus increases to 1,305 turbines, which together generate 6,382 MW of electricity.

According to the Fraunhofer Institute for Solar Energy Systems, offshore wind fed 18.8 terawatt hours of electricity into the grid last year, an increase of 8 percent compared to 2017. Its share of the power supply was 3.5 percent. At 4.66 cents per kilowatt-hour (ct/kWh), the average remuneration value for electricity produced offshore specified in the April 2018 invitation to tender again rose significantly compared to 2017. The Federal Network Agency, which is responsible for awarding the contract, announced that bids of 0 cent were again placed in this tender. The highest successful bid was 9.83 ct/kWh. A total of six bids with a total volume of 1,610 MW were awarded a contract, and the projects must be completed by 2025 (2017: four projects with 1,500 MW). However, compared to the invitation to tender, only existing projects

were allowed to participate, resulting in fewer bids. In addition, there was a so-called “Baltic Sea quota” according to which wind farms with at least 500 MW in the Baltic Sea had to be awarded a contract.

Expansion volume must be increased

The German Federal Government’s current offshore expansion target is 15 gigawatts (GW) by 2030, although the coalition agreement stipulates that the share of renewable energies in electricity generation should rise to 65 percent by this year. In addition, offshore wind energy is to make an unspecified contribution to closing the gap as far as possible in achieving the climate protection targets for 2020, which have already been declared failed. The Federal Association of Offshore Wind Farm Operators (BWO) and the Offshore Wind Energy Foundation therefore demand that the expansion volume be increased to at least 20 GW by 2030.



View from the transformer station at Arkona offshore wind farm. Photo: Paul-Langrock.de

“The GWEC expects new capacities of 6 GW or more per year.”

Despite this, Europe remains the offshore leader, as the international umbrella organisation Global Wind Energy Council (GWEC) determined in its Global Wind Report. Germany and the United Kingdom alone are responsible for the construction of 2,281 MW. Elsewhere in Europe, 380 MW were installed – a total of 2,661 MW. However, the record increase of 3,148 MW in 2017 was clearly not achieved. The worldwide increase is 4,500 MW and thus at the level of 2017, with a total of 23 GW installed. Last year, China took the lead for the first time with 1,800 MW. The GWEC expects the global offshore wind market to continue to grow. Europe will supply a stable volume and, with China, the Asian market will play a leading role. There will also be an increase in offshore installations in North America in the near future. Overall, the GWEC expects new capacities of 6 GW or more per year.

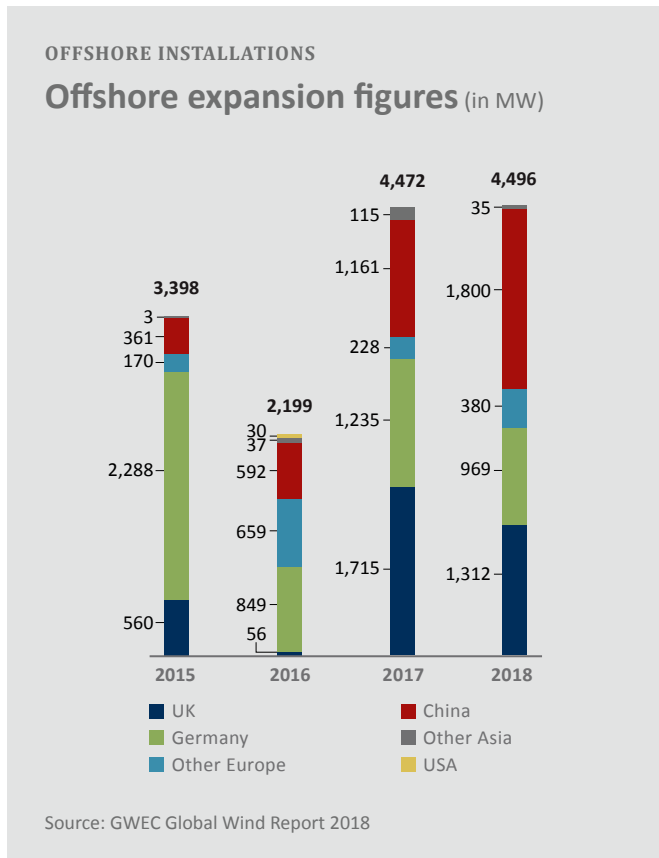

E.On offshore wind farm Arkona. Photo: Paul-Langrock.de



Concepts for the price war

The cost pressure in the wind energy sector is forcing turbine manufacturers to bring ever more efficient and larger wind turbines onto the market. Engineers react with technical innovations and cost-optimised designs.

Due to the changeover to the tendering system and the resulting price competition, manufacturers of wind turbines are coming under increasing pressure. All previous concepts and costs are put to the test. This is the only way to keep wind turbines competitive at auctions. This is primarily a matter of reducing electricity production costs. The turbines must generate higher yields at lower costs. The manufacturers are relying on efficiency here: With larger rotors, higher towers, and greater rated capacity, the turbines can achieve an optimum energy yield even at locations with very little wind, and they can significantly increase yields at good locations. The trend has been towards ever larger turbines for quite some time.



Enercon E-160 EP5.
Photo: Enercon

According to an analysis by the Onshore Wind Energy Agency, 42 percent of the turbines newly installed in Germany in 2018 have a capacity of 3-4 megawatts. Fifteen percent of new installations even have more than 4 MW. A total of 35 different types of turbines were installed in 2018, the most popular being – as in the previous two years – Enercon’s 3 MW model E-115 with 191 commissionings. Second place went to the Vestas V126 model, of which 84 turbines with rated outputs of 3.3 to 3.6 MW were installed. Enercon was the market leader in Germany again in 2018, 398 of the 762 new turbines were set up by the Aurich-based company. Vestas was able to notch up 184 new installations. They are followed by: Nordex (72), Senvion (49), Siemens Gamesa (38), Eno Energy (12), and GE (6).

Manufacturers rely on modularisation and standardisation

The constantly growing pressure in terms of cost and competition as well as the weakening market in Germany pose enormous challenges to manufacturers of wind turbines. The companies are continuously working on new, even more powerful and efficient turbines. Modularisation and standardisation are critical concepts. At **Enercon**, the E-147 EP5 (rated output 5 MW) and the E-160 EP5 (4.6 MW) are new turbines in the +4 MW class for medium and low-wind locations. “Both new developments are based on the EP5 platform, which like the new EP3 platform builds on a compact and cost-optimized design”, writes the company. For the EP3 series, Enercon relies on the fact that key components such as the nacelle and rotor hub are finally assembled at the factory in order to save time on the construction site.



Enercon’s E-115 was the most popular turbine in 2018.
Photo: Jan Oelker



Vestas V150. Photo: Vestas/Frank Boutrup Schmidt



GE's Haliade-X with a 12 MW direct drive generator. Photo: GE

Senvion also relies on modularisation. According to the company, all new onshore and offshore platforms are based on existing models. This means “less risk, faster certification, and a shorter time to market”. **Vestas** plans to start series production of the new V150-5.6 MW and V162-5.6 MW models, which are also based on a modular design, by mid-2020.



Nordex N149. Photo: Nordex

Nordex is currently trying to win favour with customers with the N149/4.0-4.5 wind turbine, a further development of the Delta generation. The first turbine was erected in August 2018.

With the “Cypress platform” with a rated output of up to 5.3 megawatts and a rotor diameter of 158 metres, **GE** currently has the largest onshore turbine in its portfolio according to its own information, and a first prototype has already been installed. Offshore, the dimensions are even greater: the company plans to install the prototype of the 12-megawatt Haliade-X turbine before the end of this year. This construction will also use the longest rotor blade in the world spanning 107 metres.

ONSHORE WIND ENERGY

Development of turbine dimensions

(Average of newly installed turbines)

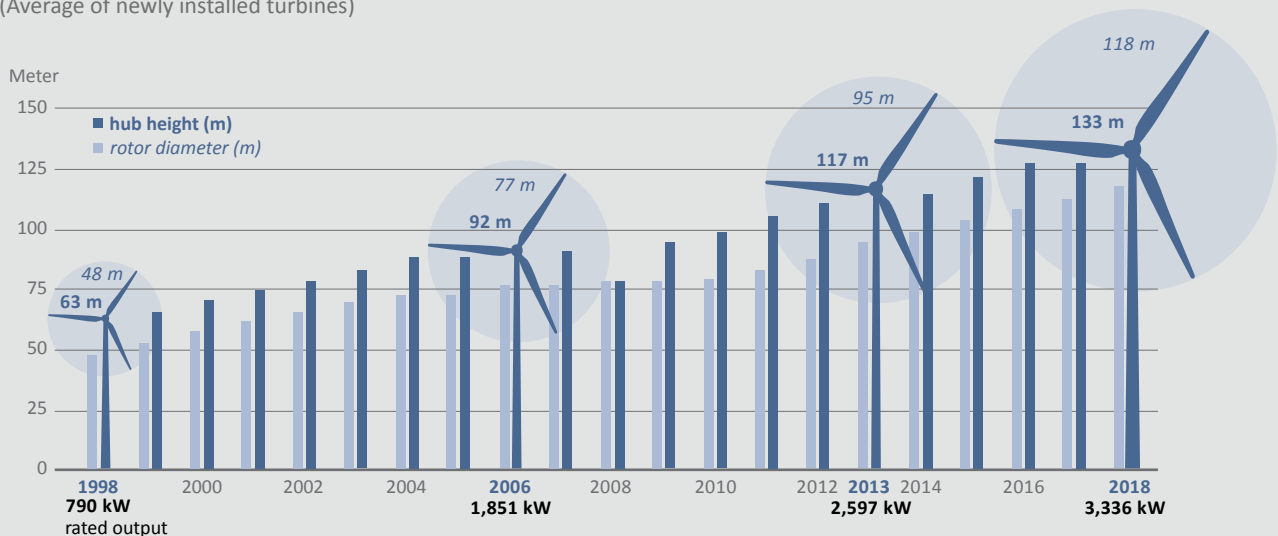

Source: Fraunhofer IWES

Wind energy is becoming increasingly affordable

The costs of wind energy are falling everywhere, and renewable energies are now the most cost-effective form of electricity generation in many places. Hundreds of billions of dollars are invested in this technology worldwide. However, Germany has lost some of its attractiveness.

In the second bidding round in May 2019, the average project award value for onshore wind energy in Germany rose slightly from 6.11 cents per kilowatt hour of electricity generated (ct/kWh) to 6.13 cents compared to the first round. This represents a further increase compared to the average value of the four bidding rounds in 2018, which came to 5.6 ct/kWh. Experts see the reason for this above all in the lack of competition: the auctions were clearly undersubscribed; there was more supply than demand.

“The difficult situation with regard to permits for the installation of wind turbines by the responsible state authorities continues to have a decisive influence on the tendering procedure and result”, explained the Federal Network Agency responsible for the auctions. The wind industry in Germany is currently in a difficult situation: more and more projects are stuck in long approval procedures due to nature conservation conflicts or are subject to complaints; the expansion has seen a massive decline (p. 10).

Despite the current exceptional situation in Germany, the costs of renewable energies in general and wind energy in particular continue to fall. According to the Renewable Power Generation Costs 2018 report of the International Renewable Energy Agency (IRENA), renewable energies are the most cost-effective form of electricity generation in most parts of the world. As per the report, the worldwide weighted average electricity production costs for onshore wind fell by 13 percent compared to 2017 – to 5.6 US cents per kilowatt hour.

GERMANY BETWEEN 2000 AND 2017

Investments in the installation of onshore wind turbines

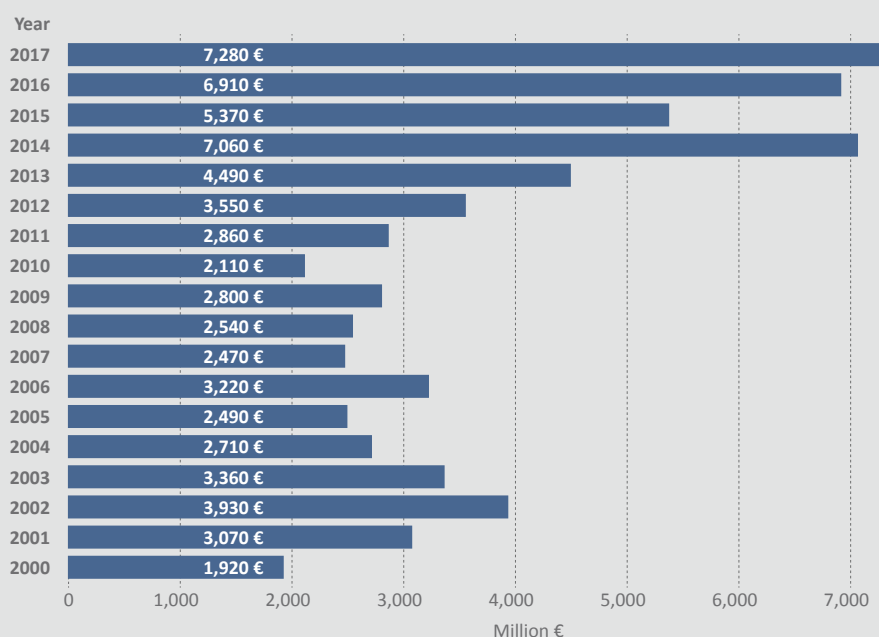

Source: Working Group on Renewable Energy Statistics (AGEE-Stat)



RWE lignite power station in Weisweiler.
Photo: Paul-Langrock.de

“The costs for electricity from onshore wind energy are now at the lower end of the cost range for fossil fuels”, IRENA says. Costs for offshore wind energy fell by one percent. The agency assumes that the cost reductions for renewable energies will continue in the coming decades.

“The costs for electricity from onshore wind energy are now at the lower end of the cost range for fossil fuels”

France has the most attractive investment conditions

According to Bloomberg New Energy Finance 2018, over 332 billion US dollars have been invested in renewables worldwide. For the fifth time in a row, investments in renewable energies exceeded 300 billion dollars. Wind energy accounted for 128.6 billion dollars, an increase of three percent. In Europe, the wind industry invested 65 billion euros, of which 26.7 billion euros were invested in new wind farms, and the remainder in refinancing transactions or project and company acquisitions (figures from the Wind Europe umbrella association). At 60 percent, the wind industry accounts for the largest share of all investments in new electricity capacity.



Coquelicot wind farm, France. Photo: Jan Oelker

According to the Allianz Climate and Energy Monitor 2018 of Allianz Insurance, the NewClimate Institute, and the environmental organisation Germanwatch, the most attractive investment conditions for renewables currently prevail in France when comparing the G20 states. Germany dropped to second place. “Germany moved down one place as the quality of the overall renewable energy policy environment deteriorates and there are some shortcomings in policy-making”, the report says. In the 53rd country attractiveness index for renewable energies of the consulting firm EY, Germany has even fallen by two places and now ranks sixth.



Rotor blade transport to Saint-Georges-les-Bains wind farm, France.
Photo: Jan Oelker

Not yet ready for the scrap heap, even after 20 years

In a few years, the first wind turbines will no longer be eligible for EEG subsidies. In view of the electricity exchange prices, continued operation is not worthwhile for many operators. However, this could change in the future. In addition, companies that are taking over old turbines have stepped onto the scene.

At the beginning of 2021, subsidies under the Renewable Energy Sources Act (EEG) will end for the first wind turbines. Then the fixed feed-in tariff will no longer be applicable. Between 2021 and 2025, around 16,000 megawatts (MW) of installed capacity will be affected, which will then be without a functioning business model. Even though they will soon reach the limit of their originally planned service life, the turbines could still reliably produce clean electricity.

Under the current framework conditions, however, their continued operation is usually not worthwhile. Without EEG subsidies, operators can primarily sell their electricity on the electricity exchange. However, the low price there makes them lose out in terms of profitability. According to calculations by Agora Energiewende, a think tank supporting the energy transition in Germany, the price averaged 4.4 cents per kilowatt hour (kWh) in 2018.

But there is hope: experts expect the situation on the electricity exchange to improve due to the closure of fossil power plants and a higher CO₂ price. According to a study by the consulting firm Enervis Energy Advisors, the price of electricity will continue to rise in the future. The analysts base their assumption on the World Energy Outlook published by the International Energy Agency.

Small turbines with little chance of success

In order for continued operation to make economic sense, the revenues from the electricity generated must not only cover operating costs such as service and maintenance, but must also refinance all costs of continued operation such as expert opinions and permits. Studies have shown that operating costs amount to 2.64–5.00 cents per kilowatt hour produced, depending on the type of turbine and the quality of the location. As a general rule, the larger the wind turbine and the more power it has, the greater its chances of continued operation. However, industry representatives assume that even with operating costs of 4 cents, 50–60 percent of the turbines cannot be operated economically. These are relatively small machines with high basic costs and high costs per kilowatt hour generated.



In operation for 20 years: Enercon E-66 at the motorway junction Bayreuth/Kulmbach. Photo: Jan Oelker

Dewind D8 type wind turbines have been in operation since 2002.
Photo: Jan Oelker



The good news is that almost all old turbines can be safely operated going forward. Whether this is worth it, however, does not only depend on the price of electricity. The maintenance and operating concept is also important. All prices for spare parts, service, maintenance, leases or insurance must be carefully checked, adjusted or renegotiated. The point is to keep the turbine running as inexpensively as possible. Expensive maintenance contracts or full maintenance are no longer economically viable. Turbine manufacturers and service companies have also responded to this and developed corresponding service offers.

CONTINUED OPERATION

Rated output of old turbines after the end of EEG subsidies

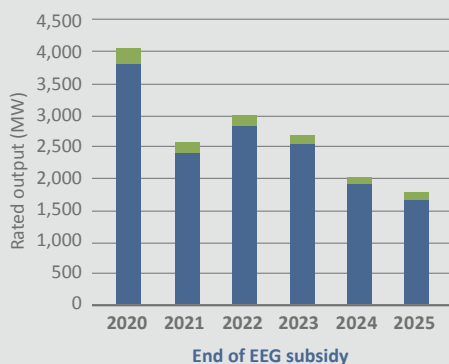

■ The green area shows plants that were still present at the time of analysis but may be decommissioned before they drop out of EEG remuneration.

Source: Deutsche Windguard

The issue of continued operation is particularly difficult for small operators. They usually do not have the financial means to continue operations with initially meagre proceeds and technical risk, or they shy away from the organisational effort. If their turbines are nevertheless to remain on the grid, they can also sell them for continued operation. In 2018, companies such as Hanse Windkraft and Windplus came onto the scene to take over specific wind farms or individual turbines from existing operators. This means that old and paid turbines can continue to generate clean electricity reliably even after 2021 – and that is also good news for the energy transition.

PPAs also gaining ground in Germany

With long-term supply contracts, known as PPAs, renewable energy producers can make themselves independent of state subsidies. In Germany, too, markets are evolving, but there is room for much more, say experts.

For a long time they were not an issue in Germany due to the adequate and secure support for renewable energy plants through the feed-in tariff. However, a growing market for PPAs (Power Purchase Agreements) is now also emerging in Germany. These are long-term electricity supply contracts between operators of renewable energy plants and industrial customers or electricity suppliers. Especially for old wind turbines, which, in accordance with the German Renewable Energy Act (EEG), will no longer be subsidised within a few years, this offers a perspective for continued economic operation (page 26).

ENERCON will supply the production sites and coldstores of leading German logistics companies and food producers with environmentally friendly electricity at a fixed price as part of a power purchase agreement (PPA)
Photo: FRIGO Coldstore Logistics

According to a study by the consulting firm Deutsche Windguard, wind turbines with a total rated capacity of 4,000 megawatts will no longer benefit from a fixed feed-in tariff from 2021. Between 2021 and 2025, a further 2,300 to 2,400 megawatts could be affected. Various options are available to the operators after the subsidies stop: they can dismantle the turbine, repower it, or continue operating it. However, the continued operation threatens to fail due to economic viability: in view of low and fluctuating prices on the electricity exchange, an extension of the term is likely to be worthwhile for only a few.

Both sides benefit from the fixed price

This is where PPAs come in. They are used to agree on the permanent supply of a certain amount of electricity at a fixed price, irrespective of the electricity exchange. In countries such as Sweden, the United Kingdom or the USA, this form of electricity marketing has been common for some time. According to financial services provider Bloomberg New Energy Finance, in 2018 companies worldwide purchased 13.4 gigawatts (GW) of clean energy through PPAs. To provide a sense of scale: in 2017 the total was only 6.1 GW. And if the contract details are right, PPAs are a win-win situation for both sides: wind turbine operators can sell their electricity at lucrative prices over the long term and continue to operate their old turbines. Customers benefit from a stable electricity price and are protected against price increases. In addition,



many companies now want to become “greener” and are pursuing a corresponding sustainability strategy. The purchase of green electricity is an important step here.

One of the first companies to conclude PPAs in Germany last year included the direct marketer Statkraft, which supplies industrial companies with electricity from six wind farms, and the wind turbine manufacturer Enercon, which supplies cold stores with electricity from four wind farms. Greenpeace Energy also entered the PPA market and launched what it considered the first PPA in Germany in September 2018. The green electricity supplier wants to supply its customers directly with green energy from northern German wind turbines. Greenpeace Energy announced that the contract will come into force on 1 January 2021 with a term of five years. In May 2019, its competitor Lichtblick also announced the signing of a PPA with the wind turbine operator PNE. From 2021, the green electricity company will supply its customers with electricity from ten wind turbines (13 MW) from the Papenrode wind farm in Lower Saxony. The turbines were connected to the grid in 2000. Lichtblick explained that it intends to purchase the electricity from PNE up to the end of 2023.

For many experts, however, this is only the “beginning of a far-reaching development”, as the management consultancy Horváth & Partners calls it. According to the consultants’ estimates, by 2020 the electricity of about 80 percent of the turbines that are no longer eligible for subsidies could be marketed via PPAs. “This could ensure the survival of turbines whose continued operation would be unprofitable if revenue development were uncertain”, writes Horváth & Partners. The Berlin consulting firm Enervis Energy Advisors concludes in its analysis that by 2040 more than half of the European wind farms and solar parks will probably be financed through long-term electricity contracts.

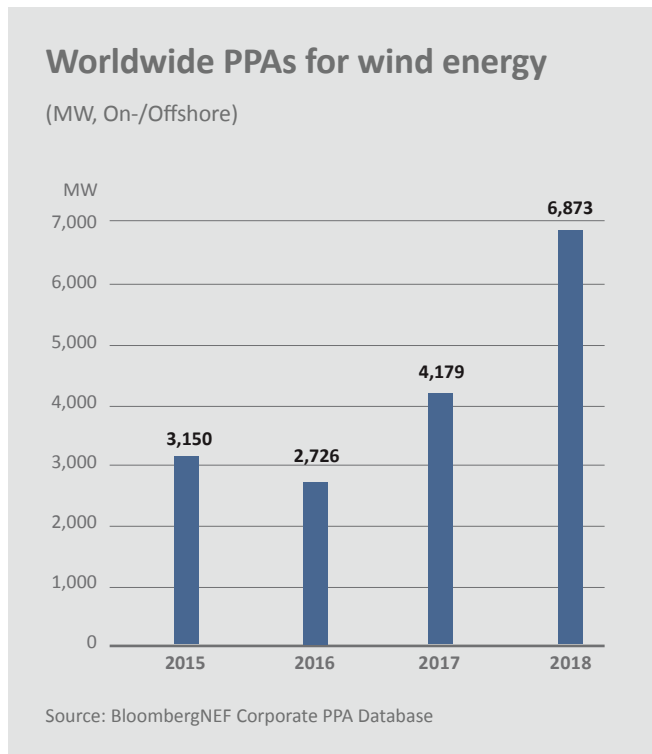

“The market for PPAs is booming above all in Scandinavia, but also in the United Kingdom, Spain, Portugal and the USA”

The experts from Aurora Energy Research show in their study that Germany still has some catching up to do compared to other countries when it comes to PPAs: “The market for PPAs is booming above all in Scandinavia, but also in the United Kingdom, Spain, Portugal and the USA. In Germany, on the other hand, the existing potential is still largely untapped.” In this country, “at least 13 percent of commercial electricity requirements could be covered by PPAs, which corresponds to a market volume of 2 billion euros.”

In September, Statkraft announced it would purchase electricity from six citizen’s wind farms in Lower Saxony for a period of three to five years once the EEG subsidy comes to an end.
Photo: Mark Mühlhaus|attenzione





Sector coupling can offer a significant reduction of CO₂ emissions in energy-intensive steel production
Photo: Salzgitter AG

SECTOR COUPLING

Renewable energies: more than just electricity

For the energy transition to be a success, renewables must replace fossil fuels not just in the area of electricity generation. The needs of the other sectors must also be met with green energy. There is still a lack of suitable framework conditions.

According to an analysis by the Centre for Solar Energy and Hydrogen Research Baden-Württemberg (ZSW) and the German Association of Energy and Water Industries (BDEW), renewable energies covered 44 percent of Germany's electricity consumption in the first half of 2019 with 128.5 billion kilowatt hours. At 47.3 billion kilowatt hours (+ 18 percent), onshore wind energy accounted for the largest share of this. In all of 2018, the share of renewables in gross electricity consumption was just under 38 percent.

In contrast, the use of renewable energies in the heating and transport sectors is stagnating. According to figures from the Federal Environment Agency, the share of renewables in the heating sector has been around 14 percent for years. In the transport sector, the share is even lower at 5–6 percent. One thing is clear: if climate protection is to be successful, all sectors must be considered as a whole and decarbonised completely. By means of sector coupling, renewable energies can also be used in the areas of heat, industry and transport, an example of which is e-mobility. Moreover, wind power can be used to split water into oxygen and hydrogen in an "electrolyser". In addition to the transport sector, the latter can also be used in energy-intensive industries such as steel production.

SECTOR COUPLING

Share of renewables in the electricity, heating and transport sector

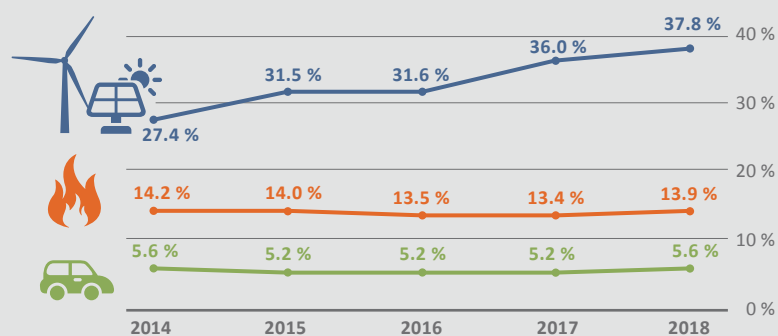

Source: AGEE-Stat

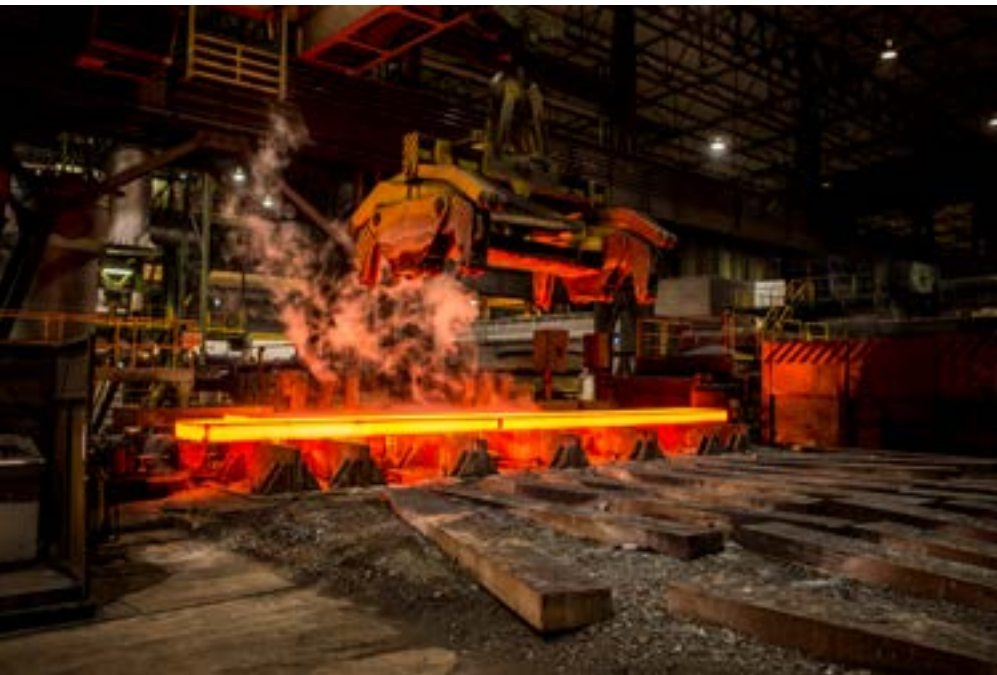

Hot strip mill at Salzgitter AG.
Photo: Salzgitter AG

Flagship projects for sector coupling

At the end of October 2018, the companies Salzgitter Flachstahl GmbH, Linde AG and Avacon Natur GmbH launched the “Windwasserstoff Salzgitter” project, which aims to generate hydrogen using wind energy. Salzgitter Flachstahl, a steel producer, intends to build and operate the electrolysis plant. The distribution grid operator Avacon, in turn, plans to erect seven wind turbines with a rated capacity of 30 megawatts on the Salzgitter site to supply the electrolyser with electricity. The industrial gas specialist Linde will supply the steel producer with the hydrogen that is generated. The costs of the project amount to around 50 million euros. If everything goes to plan, hydrogen will be generated from wind energy on the site from 2020 onwards in order to “significantly reduce” CO₂ emissions from steel production, as the companies jointly announced.

Wind energy is also expected to make a decisive contribution to the decarbonisation of shipping traffic in the future. For example, with the research project “CAMPFIRE: Fuels from Wind and Water – Energy and Maritime Mobility Transition in the North-East Region”, in which researchers are investigating how ammonia generated from wind and water energy can be used as maritime fuel and energy storage. In Schleswig-Holstein, the “West Coast 100 Living Laboratory” was also launched at the end of May.

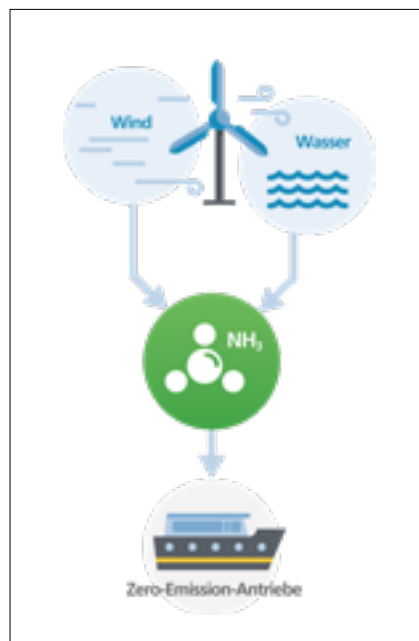

The cross-sectoral project, which will run for five years, aims to produce green hydrogen from offshore wind energy while also using the waste heat generated in the process. The hydrogen will then be used “both for the production of climate-friendly fuels for aircraft and fed into gas grids”, the project partners announced. “In fuel production without fossil fuels, unavoidable CO₂ from regional cement production is used for the production process. What is special and innovative about this living laboratory project is the integration of different material cycles within existing regional infrastructure.”

Project Campfire, zero emission ship propulsion.
Grafik: wir-campfire.de
Photo: Aleksey Stemmer – stock.adobe.com



“It is absolutely essential that existing market barriers are finally taken down”

Despite this and a number of other novel approaches, sector coupling is not yet economically viable and therefore not profitable for many players under the current tax and contribution system for the various energy sources. Old wind turbines in particular, which are no longer eligible for subsidies from 2021 (p. 26), could supply cheap electricity for a wide variety of applications. In any case, the governing parties have agreed in their coalition agreement to improve the regulatory framework for sector coupling. However, uncertainty was caused by an amendment to the Grid Expansion Acceleration Act passed at the beginning of April. Among other things, this law is intended to facilitate the construction of Power-to-X systems. Severe criticism was triggered by a change according to which electrolyzers were to be charged grid fees, which would have put sector coupling at great risk. The federal government then announced that it would amend the law once again.

The industry has long been calling for the government to speed up: “It is absolutely essential that existing market barriers are finally taken down. We now need a courageous step toward sector coupling, namely for the direct supply of trade and industry and the use of infrastructure in the gas sector, and we definitely need to bridge the gap with regard to mobility”, explains Hermann Albers, President of the German Wind Energy Association.

Power to Gas innovation project:
wind hydrogen storage system by
Uniper.
Photo: Paul-Langrock.de



Question #4: “What has been the most important innovation in your industry in the last two years and why?”



“All these steps towards artificial intelligence. Because it will dramatically reduce costs if automation not only responds to short-term events but includes entire strategies.”

GABRIEL SCHWANZER, Director Business Unit Wind, Bachmann electronic GmbH



“The most important development is the development of Na-NiCl batteries, as these are about 50 percent cheaper than Li battery cells. The necessary raw materials are widely available. The battery can be scaled at will.”

MICHAEL WAHL, Founder and Manager of GAIA mbH



“We count on integrated measurement technology in wind turbine control. The market for regenerative energies can only grow through reliable analysis and diagnostics to ensure system availability.”

DIRK KORDTOMEIKEL, Business Manager Wind Energy, BECKHOFF Automation GmbH & Co. KG



“Financing on the basis of power purchase agreements largely enables projects to be implemented without state funding. This makes renewables competitive – a cornerstone of the energy transformation.”

NILS DRIEMEYER, Director Renewable Energies, Hamburg Commercial Bank AG



“The implementation and establishment of a central online platform for line research in Germany. Transmission operators can thereby clearly be identified and grid operation can be designed safely.”

JENS FOCKE, Board of BIL eG



“Market and system integration by virtual power plants is the basis for further expansion of renewable energies and sector coupling.”

JOSEF WERUM, Managing Director, in.power GmbH



“We have successfully used our new ultra-flat ultrasonic examination system (FLAT UT) in non-destructive tests of main rotor bearings. In the case of offshore tests they no longer need to be disassembled.”

MARTIN WINKLER, Director Sales Technical Center, Framatome GmbH



“We consider the rapid progress in the energy output of wind turbines at ever higher hub heights one of the most relevant developments. The more efficient wind turbines become, the closer we will come to our goal of renewable decentralised power supply. “

JÜRGEN JOOS, CFO,
Max Bögl Wind AG



“The development of cables in 66 kV. The entire power train, from the transformer in the nacelle through to the connection with the grid cable, can now be developed at this voltage level.“

THOMAS BRANDT, Senior Key Account Manager Wind,
Prysmian Kabel und Systeme GmbH



“The most important innovation from our point of view is the digital twin along the entire value chain of the wind turbine, from design to operation. Our digital enterprise offering opens up new perspectives in the interaction of the virtual and real world for efficient, reliable and cost-effective power generation.“

KLAUS PACHE, Director of Market Development Board
Wind Equipment, Siemens AG



“One of our most exciting developments is electrothermal energy storage. We are currently developing a solution to store energy in the GWh range, cheaply and effectively.“

MARKUS TACKE, CEO,
Siemens Gamesa Renewable Energy



“The development and implementation of a fully automated stacking system for stator sheets gives our end customer an efficiency increase of approx. 30 %. This creates advantages in the highly competitive wind power industry.“

XENIA SELL, Distribution,
Strothmann Machines & Handling GmbH



“Minute reserve from wind! This is the first time that a volatile renewable energy source has assumed responsibility for grid stability – this is the prerequisite for completely renewable power generation.“

MARC KOHLENBACH, Senior Key Account Manager,
Statkraft Markets GmbH

Sustainability – many small steps towards the larger goal

The German Wind Energy Association stands for climate protection. But implementing this in everyday life is not so easy. Based on the commitment of its employees and many small steps the BWE is keen to demonstrate that climate protection is more than a political demand. Here we look at the measures taken with respect to events and publications.



Photo: Paul-Langrock.de

Measures (selection) in relation to business events

- For our approximately 100 events per year, we consistently select locations that are **easily accessible by train**.
- Participants in our events have the opportunity to book a **discounted Deutsche Bahn event ticket**. As the DB trains (ICE/EC/IC) run on 100 % green electricity, event participants travel in a CO₂-free way. In 2018, our seminar participants covered 80,767 passenger kilometres in DB long-distance traffic. Thank you!
- We make every effort to hold the seminars at **venues close to the city centre and train station** so that they can be reached by public transport or even on foot.
- All venues are checked to make sure they offer **green electricity, waste separation, and green meetings**.
- We have our **event materials** printed and transported in a **CO₂-neutral** way by offsetting the resulting CO₂ through environmental projects (*see box*).
- We design displays, boards and banners in such a way that they can be **reused for various events**.
- With regard to **catering**, we are currently developing a **climate buffet**. Until the concept can be implemented, we source **regional and seasonal products** and ensure that a large amount of vegetarian dishes are available.



In 2018, our seminar participants covered 80,767 passenger kilometres in DB long-distance traffic.

Measures in the area of corporate publishing

- Consistent use of papers from **sustainable forestry** (e.g. FSC, PEFC).
- Switch to **CO₂-neutral printing** by compensating for the resulting CO₂ (*see box*) Where possible fully **climate-neutral service providers and biological ink** are used.
- Switch from film shrink-wrapping to **cardboard packaging**.
- Like the entire German Wind Energy Association, the service department also uses **100 %** of its electricity from **renewable energy** sources.

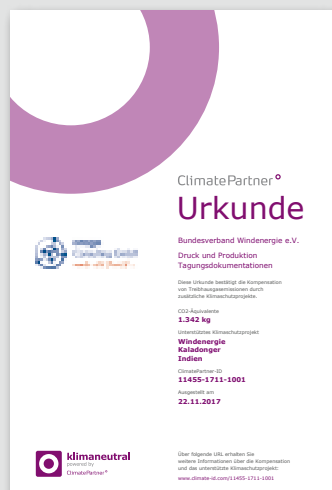

Supported climate protection projects:

Wind Power Project in Kaladonger, India,
ClimatePartner Project 1045;
More information at
www.climatepartner.com/1045

Wind energy in the Sea of Marmara, Turkey,
ClimatePartner Project 1003
More information can be found at
www.climatepartner.com/1003





DRIVERS OF INNOVATION:

Companies with innovative projects

The following pages are dedicated to companies whose new products, processes or methods ensure the continued development of the wind industry. Use the opportunity to get in touch with them and benefit from their innovation.

FLYING WIND MEASURING SYSTEM

Complex terrain and the resulting wind conditions can lead to unexpected yield losses at the wind farm. The WindLocator flying measuring system developed at the Center for Wind Power Drives in Aachen provides **planning security**.

Motivation

The annual wind energy yields of individual turbines within a wind farm in complex terrain can vary by up to 30%. One reason for this are wind phenomena, which can lead to local differences in the mean wind speed of up to 45%, e.g. due to steep ledges or obstacles (own measurement, Fig. 1). Increased planning reliability, therefore, requires a deeper understanding of the local wind conditions. Various methods are currently used to investigate these. Directive-compliant measuring systems (measuring mast, LIDAR, SODAR) offer statistical security, but are simply too immobile to produce spatially resolved insights. CFD simulations provide high spatial resolution, but are time-consuming and have large error potential due to complex boundary conditions.

The CWD WindLocator flying measuring system combines the advantages of both approaches by spatially resolving and statistically comparing the actual wind conditions.

The measuring system

The WindLocator consists of three main components: the flying carrier system, a 3D ultrasonic anemometer and an integrated analysis module.

It is based on a high-performance carrier system, which enables accurate position control at all relevant wind speeds (at peak wind speeds of up to 25m/s). The GPS system facilitates the flexible planning of flight routes and measuring points, which can be approached autonomously and thus repeatedly.

„With our system, we want to provide better insight into the local wind conditions on a scientific basis. This enables us to make a quick and cost-effective contribution to optimising the yields of our customers' wind farms.“

*Christian Ingenhorst,
project manager in charge*



Fig. 1: Mean wind speed distribution across a 25ha area at 100m above ground at a complex location in the Eifel region

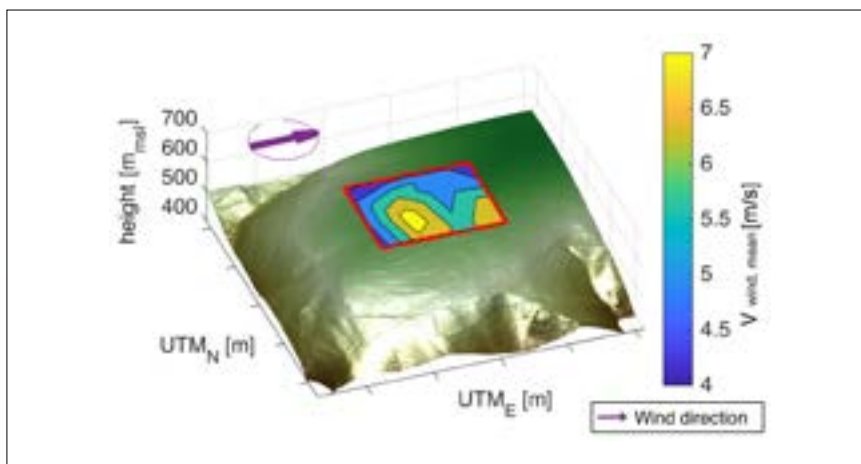

The measurement of wind speed and direction by means of the onboard anemometer is influenced by the flight system’s own movements and tilting as well as by propeller induced winds. These disturbance variables are compensated for by means of sensor fusion via an analysis module, which was developed in house, with additional position and acceleration sensors. The standard uncertainty of the WindLocator is therefore only 0.37 m/s and is therefore comparable to the specified accuracy of the anemometer itself (0.18 m/s). Local wind conditions can, therefore, be recorded in a reliable and robust manner, as was successfully demonstrated in validation tests with stationary anemometers on the measuring mast and near the ground.

Conclusion

Significant differences in the spatial wind speed distribution lead to large uncertainties in park planning involving complex terrains. The CWD WindLocator provides a faster and more cost-effective insight into the local wind conditions compared to established methods. The validated measuring system can therefore be used profitably in almost all project phases of the park planning process.

Applications

The system can be used profitably in almost all project phases during the wind-farm planning process, starting with the preliminary evaluation of potential wind farm locations, through the analysis of the overall wind conditions in the planned wind farm to the targeted identification of high-yield turbine locations. In particular, the early definition of the specific turbine locations makes it possible to use expensive, directive-compliant measuring systems only where the wind conditions really require it, thus reducing the resulting uncertainty in the wind report. The flexibility of the measuring system also allows it to be used in various application scenarios, e.g. to validate simulation results or to investigate follow-up effects.

Project overview

Initiator	In-house initiated development
Implemented by	CWD Aachen GmbH in collaboration with IME Aachen GmbH and RWTH Aachen University
Facts and figures	Autonomous, position-controlled wind measuring system, up to 25m/s wind speed, standard uncertainty 0.37 m/s
Project status	Development phase completed, sales launch completed
Location	The project is not site-specific. The system can be used throughout Germany.



Are you interested in the project and want to know how your community or your business can benefit from it? Contact us. Our contact can be found in the company profile on page 132 ▶

www.windpower-aachen.de

DIGITISED FINANCIAL ASSET CONTROLLING

Renewable energy projects can now be financially **monitored and optimised** over the entire project lifetime with a new software package from greenmatch.

Last year, greenmatch, in collaboration with a major German asset manager, began developing a digital solution for monitoring the financial performance of renewable energies. The new product GM Asset Controlling will become available in 2019.

By channelling and processing the flood of information from various sources, the major challenge in asset management is addressed. Collecting and processing information is extremely time-consuming, and the process is complicated by the many manual interfaces involved. Until now, this process has mainly involved the use of spreadsheets, making it highly susceptible to human error. The new product enables asset managers to focus more on data analysis and the implementation of measures to sustainably improve the profitability of renewable energy plants.

The new product helps asset managers to meet their reporting obligations by enabling them to monitor and optimise financial performance and simplifying liquidity and distribution planning as well as the budgeting process. Establishing connections between planned and actual figures is a central challenge in the field of development.

Greenmatch is therefore integrating the new GM Asset Controlling product directly into the existing GM Valuation product which represent plan figures. Not only does this ensure a smooth transition between the financial plan and actual performance. It also enables on going impairment tests of your project directly within a single web-based app.

Monitor the financial performance of your assets

Thanks to the unique integration of financial planning and actual figures, the new product is the ideal tool for monitoring the financial performance of an investment. Apart from comparing planned and actual figures, GM Asset Controlling provides valuable information on the reasons for deviations from the plan. This allows

for statements to be made such as: The current return is 2% below the originally planned return. The higher revenues were more than offset by higher operating and investment costs. The biggest negative effect on the return was the increase in investment costs." (see Figure 1)

Year-to-date reporting

In addition to monitoring long-term financial performance, the short-term view in the form of year-to-date key figures also forms an integral component of the new asset controlling solution. The focus here is primarily on the controlling of operating figures such as production, revenues, operating costs and EBITDA. This information provides the basis for a reliable budgeting and forecasting process.

Figure 1: IRR deviation analysis

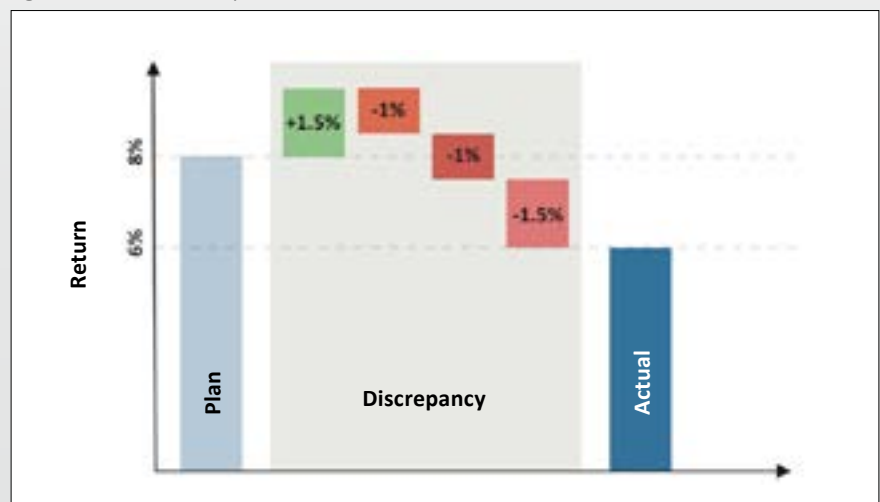
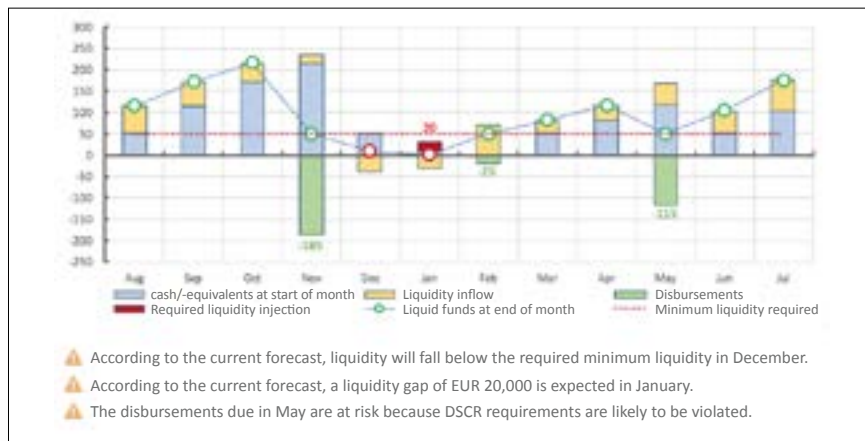

Figure 2: Liquidity planning



Liquidity and distribution planning

Another focus is rolling liquidity planning. GM Asset Controlling processes the latest available information and combines it into a liquidity plan. The system can derive hints and recommendations for action directly from the data and support the asset manager in optimally planning distributions and adapting them to the project-specific payment modalities. Figure 2 shows an example in which the planned distributions of EUR 186,000 will result in a planned liquidity gap of EUR 20,000 in the following months. The asset manager can make provisions and avoid unpleasant surprises.

Aggregation at portfolio level & benchmarking

In addition to the project-level view, the product will be extended in a subsequent step by a function for aggregation at the portfolio or investor level. This will enable monitoring of the financial performance of the overall portfolio and provide exciting opportunities for benchmarking. For example, the system will detect irregularities within the portfolio and derive indications for the asset manager using messages such as “the lease costs in Project A are 5% higher than the average”.

Conclusion

Thanks to the close link between financial planning and asset controlling in an integrated system, the new product from greenmatch offers the optimum solution for asset managers who wish to monitor and optimise the financial performance of their investments. The “Performance Monitoring” application is already developed and currently in an integration and test phase involving test customers. Collaborations with other test customers would be ideal for the further development, especially in the areas of portfolio aggregation and benchmarking.

“The new GM Asset Controlling product enormously increases both the transparency of investments in renewable energy projects and the efficiency of asset management.”

Tobias Bitterli, Co-CEO greenmatch AG



Project overview

Initiator	greenmatch AG & Deutscher Asset Manager
Implemented by	greenmatch AG
Project status	Market launch in 2019

green[::]match

Are you interested in the project and want to know how your community or your business can benefit from it? Contact us. Our contact can be found in the company profile on page 154 ▶

greenwind control: INDEPENDENT = INNOVATIVE

The company Green Wind has developed the state-of-the-art **24/7 control center** *greenwind control*, which, according to General Manager Manuel Lasse, owes its success primarily to its independence in conjunction with state-of-the-art technology.

As a result of its engagement by General Elekrtrics to assume responsibility for maintenance management of the DolWin3 offshore platform as one of two partners of ARGE O+M, Green Wind Offshore GmbH has entered a new level of technical operations management. Within the scope of the 900 MW project, the company invested in the design and construction of a state-of-the-art 24/7 control center that is now also available to other interested parties. A second major contract from Siemens Gamesa has proven to Green Wind General Manager Manuel Lasse that an independent control center like *greenwind control* meets a need in the industry.

On- and Offshore

According to Lasse, *greenwind control's* independence is what makes it truly special. There are only very few companies that offer such sophisticated technology for the 24/7 monitoring of on- and offshore wind turbines. But in contrast to large suppliers, Green Wind is not affiliated with or dependent on any manufacturers, operators, service providers, or investors: "This allows us to speak with everyone as equals – from the operations manager to the major energy supplier – without any conflicts of interest."



Digital Twin for "Albatros"

One of the company's major clients is Siemens Gamesa, which is installing 16 SWT-7.0-154 offshore turbines and the offshore transformer module with grid interfaces in EnBW's "Albatros" offshore wind farm. Green Wind Offshore GmbH was hired to organize and supervise all of the switching operations needed for the initial operation of the OTM and the wind turbines until the end of 2019. In addition, the entire grid structure has been reproduced as a digital twin in the control center software used by *greenwind control*, and is configured for both manual and optional remote control.



“In addition to all of the technical components and an exceptionally well-trained team, we also offer our customers something special – our independence.”

Manuel Lasse, General Manager of Green Wind



Control Center Sharing

But Lasse also believes the control center can be used in other ways. One of his main concepts is called control center sharing. This means that operators and independent service providers can use Green Wind technology, including 24/7 personnel, which would in turn allow them to offer their customers 24/7 monitoring and thus faster response times. This means that small and large onshore and offshore service providers can benefit from the system without having to bear the acquisition costs.

On the other hand, Green Wind can offer independent investor consulting services for complex onshore and offshore investments. This includes reviewing existing maintenance concepts to ensure that they are being carried out in accordance with the contract. Another option, according to Lasse, is to support large energy suppliers in setting up “monitoring and control systems” for infrastructure and personnel.



Two Connected Systems

All of this demands high safety standards, and one way to ensure compliance is by linking two control center systems that can replace each other if necessary. In addition, Green Wind stores all the data on servers in Germany and regularly backs it up to locally isolated and secure storage systems. To secure the systems, Green Wind relies on redundant and monitored networks consisting of select industrial-grade components. The *greenwind control* infrastructure is ISO 27001 certified.

Conclusion

***greenwind control* from Green Wind is one of the few 24/7 control centers that combines sophisticated technology and independence and can therefore be used by both small and large onshore and offshore service providers. Data security is guaranteed by the linking of two control center systems, among other measures. The infrastructure is ISO 27001 certified.**

Project overview

Initiator	Green Wind
Implemented by	Green Wind Operations GmbH and Green Wind Offshore GmbH
Facts and figures	General grid control, monitoring and management of substations, HVDC platforms, and onshore and offshore wind farms. Coordination and planning of service and maintenance. Switching authorisation up to 170 kV.
Project status	In operation since June 2018
Location	



Are you interested in the project and want to know how your community or your business can benefit from it? Contact us. Our contact can be found in the company profile on page 153 ▶

ENERGY PLANT MAINTENANCE IN OFFSHORE AREAS

The operation of 400 MW offshore wind power plants is ensured by maintenance, testing and servicing, as well as repair and 24/365 operational readiness, from a single competent source.



When a highly complex energy transmission system is installed, consisting of 36 medium-voltage switchgear panels (33 kV) with gas-insulated design, 2 155/33 kV transformers, a 155 kV GIS system and 86 medium-voltage switchgears on the wind turbine towers, supported and monitored by more than 200 digital protection and control technology devices with distance protection, differential protection and numerous OCP applications, an operating period begins in which the operator must test this complex system technology accordingly and, most importantly, ensure it remains functional. This task, in the normal environment of an application that has been tried and tested countless times, represents a real challenge for the operator in the offshore sector.

The availability of specialists with the appropriate offshore approval is one hurdle, but travel costs, local accommodation, and the limited capacity of overnight lodgings at sea also necessitate a concentration of specialist expertise in one person if possible, with appropriate redundancy.

“The process of implementation is determined by the requirement profile of the task.”

Martin Frangen, Managing Director, Koopmann Group



05



03



04

In addition, transport between the platform/hotel ship and the wind turbine towers is only possible in calm seas. Since, historically, technological boundaries exist in the German energy industry between the specialist areas of switchgear technology and protection technology as well as transformer know-how, this concentration of expertise on the basis of the requirements profile of the deployment site is the critical factor in being able to work successfully, cost-optimally and quickly.

The knowledge base of the employees must be broad as well as detailed, and the physical requirements for offshore work must be met.

- 01 | Koopmann in offshore operation
- 02 | Mobile equipment for flexible use
- 03 | Gas-insulated medium-voltage switchgear
- 04 | Reflection measurement on HV cables
- 05 | Testing the protective relays

Project overview

Initiator	Global Tech
Implemented by	Koopmann Group
Facts and figures	400 MW offshore wind power generation, 36 medium-voltage switchgear panels (33 kV) with gas-insulated design, 2 155/33 kV transformers, one 155 kV GIS system and 86 medium-voltage switchgear units
Project status	Ongoing maintenance cycle
Location	North Sea, approx. 180 kilometres off Bremerhaven



The bottom line

The development of the requirement profile marked the beginning of the Koopmann Group’s expansion into this demanding service sector. Through the development of employees and taking into account the optimisation of deployment capacities, this led to excellent results – the complex installation can be safely maintained and tested, and repaired with fast reaction times, thus securing the long-term contribution of this installed energy supply facility to the German power supply.



Are you interested in the project and want to know how your community or your business can benefit from it? Contact us. Our contact can be found in the company profile on page 161 ►

PD DIAGNOSIS FOR CONDITION ASSESSMENT OF SWITCHGEAR

The reliability of medium voltage switchgear is an important basis for the safe operation of grids. PD measurement has emerged as a suitable method for detecting damage to insulation as early as possible.

Partial discharge (PD) measurement has proven itself as a reliable diagnostic method both for SF6 gas and air-insulated switchgear. Partial discharge is the localised, short-term electrical discharge of partial capacities, which can cause irreversible damage to insulation. The longer partial discharge occurs, the greater the level of damage; ultimately this can lead to dielectric breakdown and subsequent failure of the switching system.

Partial discharges are sub-divided into external and internal partial discharges. The following causes can be listed:

- Voids within solid insulating material
- Sliding discharges along two different mediums
- Inhomogenities of the electric field
- Potential-free metal objects
- Free particles within the electric field

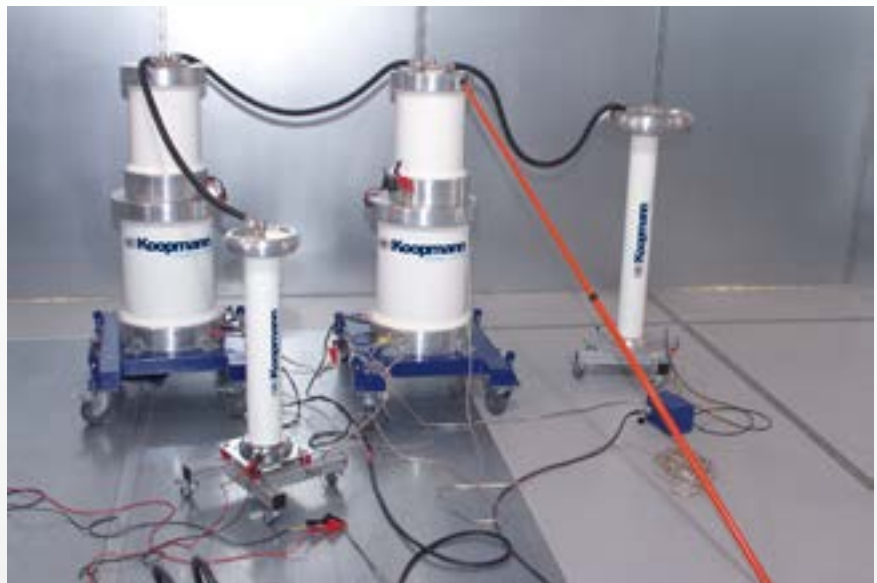

PD measuring system for up to 100 kV

In switching gear, PD can originate in screw connections, cracks, voids, free potentials on busbars, insulators, busbar glands or contact sockets with isolating contacts, as well as the cone for attaching energy cables.

Partial discharge testing has to be set up in line with IEC 60270 and IEC 62271 (DIN VDE 0671). Conventionally, PD measurement uses a PD-free coupling capacitor, a coupling device, and a PD measuring system.

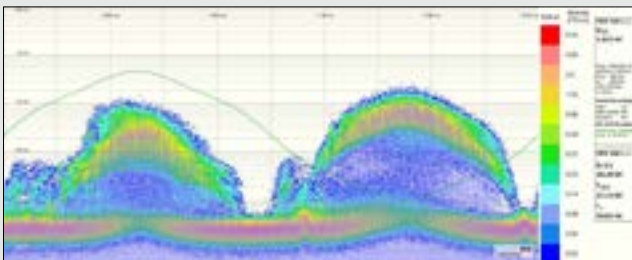

PD measurement, 24 kV GIS (imperfection between bushing and fuse tube)

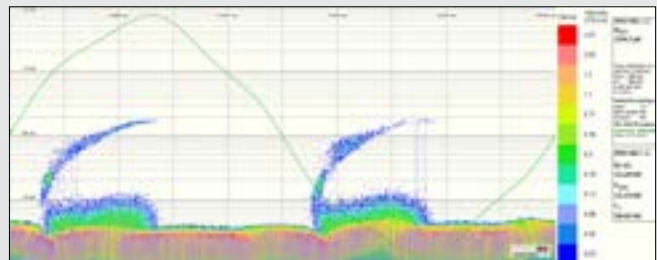

PD measurement, 12 kV switchgear of the defective capacitive insulator

“Using metrology in the preparation of maintenance is the basis of investment decisions“

Martin Frangen, Managing Director, Koopmann Group

PD measurement establishes a magnitude of PD that is usually expressed in picocoulombs (pC). However, this does not give any indication of the geometrical shape and quality of the electrical charge. In order to develop meaningful recommendations for action, not only the magnitude of PD needs to be established. The entire PD measurement results must be carefully analysed in order to reach a solid conclusion.

Measurements in the UHF range can do without a high voltage resistant coupling capacitor. Due to the very broad frequency range the radiation emitted by PD can be received by antennas and sensors. Since PD generates transversal electromagnetic (TEM), transverse electric (TE) or transverse magnetic (TE) waves, these signals can be detected by capacitive field sensors or antennas.

In the context of minimally invasive PD diagnostics, PD measurement takes place using a voltage detection system (VDS) interface. PD signals are extracted under operating voltage via the VDS interface of the enclosed switching gear.

The advantage of alternative PD measurement is that it can be done online, i.e. when the power equipment is in service. The plant does not have to be taken off the grid; customers therefore continue to receive electricity while measurement is taking place. Because of the tight requirements for alternative measurements with respect to background noise levels in the field, conventional PD measurement techniques are still the first choice in cases where these requirements are exceeded, as well as for measurements of PD with higher inception voltage than operating voltage.

Conclusion

The use of PD diagnostic techniques optimises maintenance efforts, tests operational safety, highlights any maintenance investment needs, and represents an additional, metrologically based decision criterion when it comes to the replacement, renewal or maintenance of equipment. Together with operational experience and manufacturer recommendations, these additional parameters can form the basis for any investment decision.



Defective capacitive insulator in 12 kV switchgear (see error pattern on the previous page)

Project overview

Initiator	EnBW Energie Baden-Württemberg AG
Implemented by	Koopmann Group
Facts and figures	Old switching gear constructed in 1986
Project status	completed
Location	Eastern Baden-Württemberg



Are you interested in the project and want to know how your community or your business can benefit from it? Contact us. Our contact can be found in the company profile on page 161 ►

HIGH PERFORMANCE 2.0 – SECOND GENERATION HYBRID TOWER CONCEPT

Fully exploiting the potential of wind energy – this is the goal Max Bögl Wind AG wants to realise through the further development of its **modular tower concept**.

The new generation of the Hybrid Tower Bögl reaches hub heights of up to 190 meters and enables an even faster and more economical implementation of wind towers of the highest quality due to standardised processes.

Every meter a wind turbine gains in height can increase the annual electricity yield by up to 1 percent. As an efficient combination of steel and concrete, the Hybrid Tower with maximum hub heights ensures a quick return on investment for the entire project.

But it is not only the increased output that contributes to the economic efficiency of the new Hybrid Tower: the tower concept has also been optimised in terms of project management, which saves costs, simplifies logistics and improves the assembly process.

The new foundation design simplifies the prestressing at the entrance level of the wind turbine, thereby streamlining the work processes. Higher fatigue strengths are achieved and structural peak loads are further reduced. The conical Hybrid Towers 2.0 require significantly less pre-load force and have optimised power flow.

The internals are installed using a new process patented by the Max Bögl Group: lift and ladders are installed in parallel and concurrently with the erection of the concrete tower, which reduces the installation time considerably. The engineers have also focused on logistics and transport: almost no heavy load vehicles are required to transport the individual tower segments. The use of standard trucks makes the installation of the wind turbine more flexible, less risky and faster.



Photo: Max Bögl Wind AG / Reinhard Mederer

Production of the Hybrid Tower takes place in the Max Bögl Group's prefabrication plants, where the segments are manufactured in serial production and ground to an accuracy of 1/10 of a millimetre with the aid of a CNC system. The benefit of this is that the individual elements can later be placed one on top of each other on the construction site without the use of mortar regardless of weather conditions.

Thanks to the Mobile Fabrication developed by Max Bögl, the Hybrid Tower can also be produced directly at the project location almost anywhere in the world – as was recently done in Thailand. The mobile production facility can produce Hybrid Towers directly on the construction site while maintaining the high quality standards of the German production plant, and increases local economic efficiency by involving local workers and raw materials.

This was one of the reasons why the trend-setting concept won this year's bauma Innovation Award in the construction process category.



Photo: Max Bögl Wind AG / Reinhard Mederer



Photo: Max Bögl Wind AG

Conclusion

New technologies are essential to the efficient use of wind energy regardless of location, and especially important in terms of achieving current climate targets worldwide. Innovative and at the same time economical energy solutions such as the Max Bögl Hybrid Tower concept are paving the way to a more sustainable future.

Facts on Max Bögl Wind AG

- First hybrid tower prototype in 2010
- Start of serial production in 2011
- Over 1,850 towers manufactured and installed
- More than 4,800 MW installed
- More than 42 certified tower types
- Installation of the highest onshore wind turbine by hub height in Oct. 2017 in Gaildorf (178 m HH)
- More than 220 MW of developed wind projects
- 2017–2019 first project of the Mobile Fabrication in Thailand (90 turbines)
- Winner of the bauma Innovation Award in 2019 in the construction process category



Are you interested in the project and want to know how your community or your business can benefit from it? Contact us. Our contact can be found in the company profile on page 96 ►

100 % RENEWABLE WITH BATTERY STORAGE SYSTEM

RES Deutschland GmbH is building one of the **most modern energy balancing power plants** in the world. The battery storage system will help Bordesholm achieve energy self-sufficiency and 100% renewable energy supply going forward.

Bordesholm is a small municipality with 8,000 inhabitants in the north of Schleswig-Holstein. Its municipal utility, Versorgungsbetriebe Bordesholm GmbH (VBB), generates about 75 % of the municipality's annual electricity demand from renewable energy. The municipality is aiming to cover 100 % of the electricity demand exclusively from regional renewables by 2020. VBB has been pursuing its "Vision 2020" with corresponding measures since 2008 and has set itself the ambitious goal of becoming completely independent of fossil fuels.

To make this possible, RES Deutschland GmbH has designed and built a battery storage system for VBB.

As a pilot project, the battery storage facility was supported by the state of Schleswig-Holstein and the Technical University of Cologne for research purposes. The aim of the project is to establish whether it is possible to operate a public power supply network, fed by 100 % renewable energy, as a frequency-stable standalone network.



One of the most modern balancing energy power plants in the world

The 10-MW battery storage system has been in operation as scheduled since May 2019 and is one of the most modern energy balancing power plants in the world. The battery storage system now reliably provides primary energy balancing for the Europe-wide electricity transmission network. Prequalification for participation in the energy balancing market was granted by the transmission system operator TenneT. In the event of a failure of the upstream power grid, the battery storage system acts as a "load spring" to ensure a stable grid frequency by balancing all consumers and intermittent energy production from renewable energy sources in less than 0.2 seconds.



Photos: © RES / Silke Reents

“The battery storage facilities are now at the same point as the wind and solar energy were 30 years ago. Furthermore, we need visionaries who can think ahead in the future of energy supply, because this is the only way we will be able to bring about the energy transition.”

Dominique Guillou, Managing Director of RES Deutschland GmbH

Cellular network of many self-sufficient power grids – the first cell is Bordesholm

In addition to frequency stabilisation, two further features of the battery storage system are its “standalone network” and “black start” capabilities. Black start refers to the ability to start up a power plant independently of the power grid from the deactivated state. The battery storage system is thus also able to reactivate a deactivated power grid, a feat that was previously reserved for fossil-fuel power plants. Standalone connectivity means that the local network in Bordesholm can continue to operate in the event of a grid failure. VBB is thus in a position to provide the supply area with 100 % renewable and regionally generated energy completely independently as an independent cellular network.



Performance and energy management with RESolve®

The operation of the battery storage facility is optimised with aid of RESolve®, RES’s proprietary control and energy management system. 24/7 monitoring ensures the reliability and safety of the battery storage system. The control system is based on extensive experience with grid-connected generation plants and thus provides a spectrum of grid-support and grid-protection control functions. This protects the battery storage system from surge voltage and overheating, which increases the service life of the battery storage system and optimises its performance.



Conclusion

Full supply through renewable energy is already possible today thanks to intelligent and system-compatible battery storage. These are key solutions for future decentralised energy supply from 100% renewable energy. They offer communities such as Bordesholm the opportunity to build a cellular power grid comprising many small self-sufficient power grids, which together form a district power grid but are also capable of supplying a region reliably on their own.

Project overview

Initiator	Versorgungsbetriebe Bordesholm GmbH
Implemented by	RES Deutschland GmbH
Facts and figures	10 MW/ 15 MWh lithium-ion battery storage for frequency stabilisation with black start and standalone grid capability
Project status	Completion May 2019

Location



Are you interested in the project and want to know how your community or your business can benefit from it? Contact us. Our contact can be found in the company profile on page 177 ▶

CONTINUED OPERATION OF TURBINES OLDER THAN 20 YEARS

In the past, the German Renewable Energy Sources Act (EEG) guaranteed a fixed feed-in tariff to renewable energy assets. Action is now required in the case of assets whose subsidies expire after 20 years. Direct marketers such as Statkraft are using PPAs to ensure that continued operation is cost-effective.



PPAs are receiving increased attention, because the fundamental question is: How can both existing and new renewable energy assets be marketed and financed in the future? As a power offtaker, under PPAs, Statkraft can assume significant risks related to the operations of renewable energy assets that have until now been covered by the EEG subsidy or other support mechanisms.

Power purchase agreements (PPAs) enable wind farms to continue operating after their EEG subsidies expire. They are usually long-term power purchase agreements between an electricity producer as the seller and a power offtaker as the buyer. Private or public utilities, as well as large end consumers, power trading companies, or even direct marketers such as Statkraft can be considered as buyers. PPAs have existed since the beginnings of electrification, but they have not played a significant role in Germany in recent decades. However, this

is changing, as both technology costs and feed-in tariffs are sinking, and EEG subsidies for existing plants are expiring: The demand for alternative marketing models for the continued commercial use of existing renewable energy assets, primarily wind farms, is increasing.

Until now, the EEG has hedged price- and volume-related risks as well as technical risks for renewable energy assets through a fixed feed-in tariff. Wind farms whose EEG subsidies expire after 20 years have to bear these risks themselves – if they decide to continue operating their plants. This is where direct marketers such as Statkraft come in, because as power offtakers, they assume at least some of the risks.

Without EEG subsidies, on the free market, the risks described above result in the following problem: If the operator of a wind farm sells their electricity on the stock exchange or to an end customer in the long-term in order to fix the unit value, the operator enters into a delivery obligation, which usually is a binding restriction on both the delivery quantity and the delivery period. However, if there is no wind, or if the plant has a major technical defect and the operator is unable to meet the delivery quantity or period, he must procure the contractually guaranteed electricity elsewhere – and possibly at higher prices.

How does it all fit together?

Example: Weekly energy consumption of an industrial company and the respective share derived from renewables GWh, week

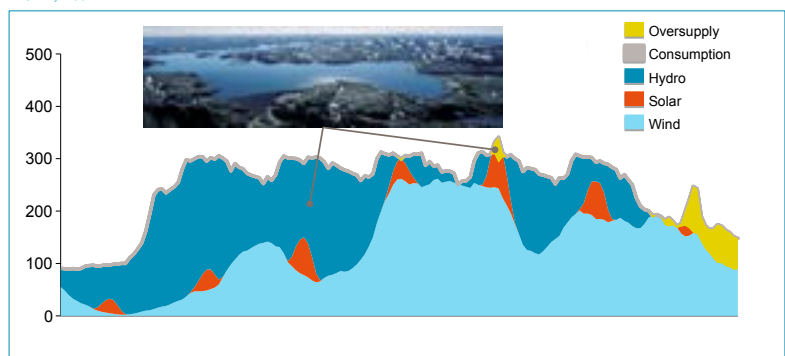

“PPAs will receive increased attention, because the fundamental question is: How can both existing and new renewable energy power plants be marketed and financed in the future?”

On the other hand, excess generated electricity can also pose a considerable financial risk if energy prices are negative. If, on the other hand, the operator chooses a marketing channel via short-term trading, they will need to worry about high price fluctuations, which can at least partly lead to revenues that are below the operator’s marginal costs. This problem is present for both new installations that are not subsidised as well as old installations that stop receiving EEG subsidies after 20 years.

A power purchase agreement with a direct marketer enables the power plant’s operator to continue the commercial operation of their plant, even if it is not covered by EEG subsidies, and provides them with the security needed for planning.

Another significant aspect of the marketing of renewable energy assets that are outside the EEG is that once the EEG payment is withdrawn, the prohibition of multiple sales¹ will no longer apply, and the green added value of the electricity will be freely usable for the first time. This will allow power plant operators to market the green added value of their power plants in addition to the agreed electricity price. Statkraft can now offer green electricity to business and industrial clients to meet their sustainability targets. These end users may demand a steady supply of electricity, which must be provided. For this reason, intelligent portfolio management is necessary when marketing renewable energy to end users; the decisive factor here is the mix of technologies. Statkraft offers both: several years of experience in marketing renewable energy to end users and access to one of the largest renewable energy portfolios in Europe.

Wind farm	Number of turbines	Installed capacity
Schliekum	3	4.5 MW
Kunst und Wind	5	7.0 MW
Meerberg	6	9.0 MW
Rebenstein	3	4.5 MW
Bassum	13	19.5 MW
Sonne und Wind	1	1.5 MW

1—Power plant operators who [...] market this electricity directly in the forms referred to in Article 33b (1) may not pass on proofs of origin, or other evidence proving the origins of this electricity, for this electricity.” Source § 56 EEG

Conclusion

Statkraft has concluded the first PPAs, which will enable the continued operation of renewable power plants after EEG subsidies expire, with six community wind farms. The contracts encompass 31 wind turbines with a total rated capacity of 46 MW and an operating time of three to five years. The electricity is purchased by Mercedes-Benz Cars and used to power the Mercedes Benz plant in Bremen, as well as German battery facilities such as the ones in Kamenz and Stuttgart-Untertürkheim.



Copyright: Windpark Kunst und Wind



Are you interested in the project and want to know how your community or your business can benefit from it? Contact us. Our contact can be found in the [company profile on page 179](#) ►

LIGHTER GENERATORS WITH SUPERCONDUCTORS

Within the EU EcoSwing project, for the first time ever a superconducting 3 MW generator fed power into the grid. Superconducting generators will enable a weight reduction of up to 50 % in the future.



Space savings become apparent when comparing the conventional PM generator to the superconducting one (right hand side)
Photo: ECO 5

Superconductors are able to transport electrical current without resistance when cooled to low temperatures. Then the current density can be hundredfold higher compared to other conductors. With high temperature superconductors, this state can be reached at higher temperatures which are much easier to realize. This enables applications in energy technology, e.g. generators. These applications profit from the high current density as their design can be smaller and more compact.

In 2015, the nine partners of the EU Horizon 2020 project EcoSwing started the development of the world's first superconducting wind power generator. THEVA's task was to develop and deliver the superconducting coils.

In March 2018, the generator was tested at IWES in Bremerhaven. After commissioning and installation in Thyborøn, Denmark, the last milestone of reaching 3 MW power output was reached. During the tests the superconducting coils as well as the cryogenic cooling system have proven to be particularly robust and reliable – under real conditions. The cooling system of the wind power generator as an example was stable over seven months of operation. This is a major step for series maturity.

Looked at in detail, the 3 MW generator has 40 coils. Each coil is about 1.4 meters long and 0.2 meters wide, which adds up to around 25 km of superconducting wire, explains Dr. Markus Bauer, VP Business Development at THEVA.

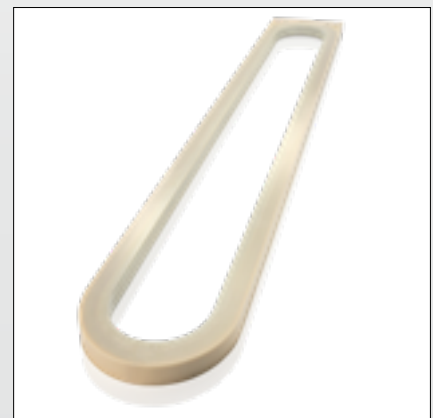

One of the superconducting EcoSwing coils.
Photo: THEVA

With the first series production of superconductors in Germany THEVA is pursuing the goal to decrease the cost of superconductors sufficiently to become competitive with copper. This will facilitate innovative new products that will become an important contribution to the energy transition in the future. Accordingly, THEVA has a portfolio of superconductors and coils tailored to the needs of various applications.

“Basically, anything is possible”, says Bauer. “Generator manufacturers can design and manufacture coils in different sizes, geometries and performance levels with our material”.

After the success in the EcoSwing project, the development of a generator for cost-efficient series production can begin. The EcoSwing design can be scaled up for nominal powers of 15 MW and above. The lower mass and bigger air gap coming from the specific properties of the superconductor result in less demanding construction and easy assembly. Due to the significantly reduced size and weight, costs are lower for foundation, supporting structures, installation space and logistics. Therefore, THEVA expects superconducting generators to reach a relevant market share for big wind turbines in the future.



Superconductor and copper cylinder with the same current carrying capacity. Photo: THEVA

Conclusion

THEVA and the EcoSwing consortium showed that a superconducting generator can be operated reliably. Mass reduction in the nacelle offers new perspectives especially for high power ranges and for offshore turbines. THEVA is open for a follow-up project to develop market maturity for superconducting wind power generators.



Envision’s GC1-Turbine in Thyborøn, Denmark. The superconducting generator was mounted and tested on this turbine. Photo: THEVA

Project overview

Project	EU Horizon 2020 Projekt EcoSwing
Coordinator	Envision Energy
Partner	THEVA, Envision Energy, ECO 5, Jeumont Electric, Delta Energy Systems, Sumitomo Cryogenics of Europe, Fraunhofer IWES, Universiteit Twente, DNV GL

End of project 30.04.2019

EcoSwing has received funding from the European Union’s Horizon 2020 research and innovation programme under grant agreement No. 656024. The text reflects only the author’s view. The Commission is not responsible for any use that may be made of the information it contains.

THEVA

Contact ecoswing.eu

NEWCOMERS:

Start-ups

Start-ups are entering the market with new ideas. A selection is presented on the following pages. Be inspired by their innovative power.



The EUREF campus in Berlin is home to many start-ups in the field of renewable energies.
Photo: Christian Kruppa



Sustainable energy storage systems to support the energy transition

CMBlu Energy AG is a pioneer and market leader in the field of **organic flow batteries**. Its aim is to provide sustainable and highly cost efficient storage technology to secure the success of the energy transition. It also aims to support e-mobility by enabling the expansion of charging infrastructure by means of buffer storage.

One of the largest research and development centres for organic flow batteries worldwide is located in Alzenau, Lower Franconia (Bavaria). CMBlu is working on a key component for the successful energy transition – large-scale and cost efficient storage batteries for electricity grids.

Functional principle

The functional principle is similar to that of conventional redox flow batteries. These essentially consist of two tanks with aqueous solutions, so-called electrolytes, and an energy converter. The converters consist of a large number of cells arranged in a row, also called “battery stacks”. The electrolytes are pumped through the stacks in a closed

cycle, charging or discharging the stacks as required.

From initial idea to marketable product The business idea for redox flow batteries with organic electrolytes (“organic flow”) first arose in 2011 and has been the subject of intensive research and development at CMBlu since 2014. Dr Peter Geigle is one of the founders and CEO of CMBlu. Trained as a medical doctor, he spent decades working on the energy supply of brain cells. The basic idea goes back to the human body where nutrition is converted into energy in the citric acid cycle. This is another redox reaction but one that is based on organic molecules – ring molecules that are able to take up energy, store it and discharge it as needed. This principle is now being transferred to industrial applications. The start-up is currently preparing to market its first commercial systems in 2021 together with its industrial partners Schaeffler, Mann+Hummel and Schunk.





CMBlu Energy AG
www.cmblu.de

Twitter:
https://twitter.com/CMBlu_AG
LinkedIn:
www.linkedin.com/company/cmblu-energy-ag
Xing:
www.xing.com/companies/cmbluenergyag

Founding year	2014
Staff	70
Focus	Energy stores
We offer	Large-scale, modular and sustainable energy stores for integrating wind and solar energy and for e-mobility charging infrastructure.
We are looking for	Customers with large storage needs and outputs of at least 200 kW or capacities of > 1MWh, for delivery from 2021 onwards.

High and very affordable resource availability

The electrolytes of organic flow batteries can be obtained from lignin, a natural material that contains particularly large numbers of ring molecules. Lignin is contained in every plant with structure, where it lends them stability. Straw and wood are especially high in lignin. Lignin therefore represents a renewable raw material, of which more than 50 million tons are generated annually as a waste product in pulp and paper production. The majority is currently incinerated due to the lack of alternative uses. The long-term availability of this resource for electrolyte production is therefore ensured. Moreover, the value added chain is entirely local and no scarce resources need to be used, making the organic flow battery particularly sustainable.



A versatile energy storage system

There is no question that storage systems play a significant role in a future energy system that largely relies on wind energy. The share of wind and solar energy in the electricity mix can only be increased if very large storage capacities become available. Organic flow batteries are highly scalable in terms of output and capacity, making them attractive for a wide range of uses such as interim storage of renewable energy or balancing peak loads in industry. When used as buffer storage systems, these batteries also enable the introduction of comprehensive charging infrastructure for e-mobility.

“Over hundreds of millions of years nature has developed very efficient and safe methods for storing energy. Our ideas are based on how energy is stored in the human body. This uses a redox reaction within the citric acid cycle based on organic molecules. We are proud to be able to apply this principle to the large-scale storage of electrical energy using unlimited and renewable resources. We therefore enable very large and cost-efficient energy storage systems.”

*Stefan von Westberg,
Director, Distribution & Marketing*

Conclusion

Organic flow batteries by CMBlu enable energy to be stored sustainably and cost-efficiently and in a way that can be flexibly scaled. The batteries are suitable for various applications, including interim storage of solar and wind energy, balancing peak loads in industry, and providing high output to simultaneously fast-charge electric vehicles.

cms@wind – Innovative Condition Monitoring

cms@wind GmbH uses innovative CM methods to monitor large slow-turning components in drive trains that move at variable speeds

Condition Monitoring is a red flag for many in the wind industry. For us as a young and innovative company the challenge is to develop a working solution that is also customer-friendly. We start where other systems stop: with components that are difficult to monitor because of their good damping properties in combination with slow, irregular movements. These pose particular challenges to CMS.

Analysis is at the heart of what we do. Our innovative algorithms make us successful even in cases where systems designed for other demands fail. Our CMS delivers the diagnoses required by key directives and much more. But we get there in a different way. Analyses are non-parametric and can therefore be automated.

For analyses to be relevant, it is essential for the signal base to contain the elements that are critical for early fault detection. This strongly limits the choice of suitable systems. Our sensors, hardware and post-processing are fine-tuned to this. CMS consists of many details, and they all have to fit together if we are to meet our own demands.

Apart from our innovative early fault detection system, which has been used by certifiers since 2018 for end of warranty assessments, we introduced an affordable hardware in 2018 that was developed between 2016 and 2018 in an AiF-funded project and successfully tested in a turbine. The hardware is now ready for serial production. We added a user interface so that no commissioning engineer needs to leave the turbine without first checking that all sensors are working correctly. The interface was conceived to be especially suitable for the mobile measurements that are frequently demanded by periodic inspections.



User Interface

cms@wind GmbH
 Am Diebsteich 31
 22761 Hamburg
 Tel.: +49 (0)40 63797707
 info@cms-wind.de
 www.cms-wind.de

Founding year	2015
Staff	4
Focus	Condition Monitoring an unregelmäßig drehenden Großkomponenten
We offer	<ul style="list-style-type: none"> - Independent measurements - Innovative CMS solutions for large slow-turning components in drive trains that move at variable speeds - Optimised for wind energy - Monitoring of slewing bearings, tested up to 4 m
We are looking for	<ul style="list-style-type: none"> - Contracts, new clients, partners - Interesting tasks related to measurement, periodic monitoring, new turbines, old turbines, reference measurements, resonance analysis, relation to other physical parameters - We start where others stop.

As a young company, we had many smaller familiarisation projects in older turbines in our first three years. The oldest turbine was 27 years old. These turbines often have some damage that is merely being watched as repairing it is no longer worth it. Here, it is important to recognise critical states early in order to avoid danger. Methods of early fault detection do



CMSmobil

not help here. We developed a concept that enables remote monitoring through a combination of innovative analytical methods, affordable hardware and classic fracture mechanics, in order to respond quickly if the turbine is in a critical state. If the turbine is to be decommissioned earlier than planned, the system can be easily transferred to another turbine where it can continue operating.

In 2019 we began to market the second product developed in our AiF-funded project. The main bearings in wind turbines are a real challenge to structure-borne sound diagnostics. Together with the new hardware we tested a high resolution sensor that relies on infrasound and delivers convincing signals. As it is flat in shape, the sensor can easily be mounted onto parts that are difficult to access.



CMScontrol

Exciting topics continue to be presented to us. In 2018, after a long and interesting mobile project in a very large wind farm, we decided to integrate unbalance measurements as an add-on in the online system. We also incorporated multi-axle MEMS sensors in our portfolio.

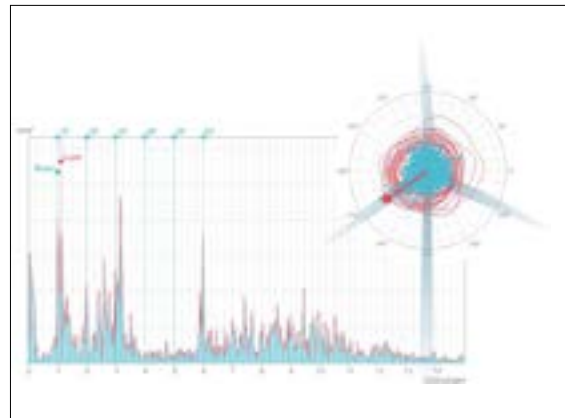

Example – evaluation – rotor/tower resonance (unbalance measurement)

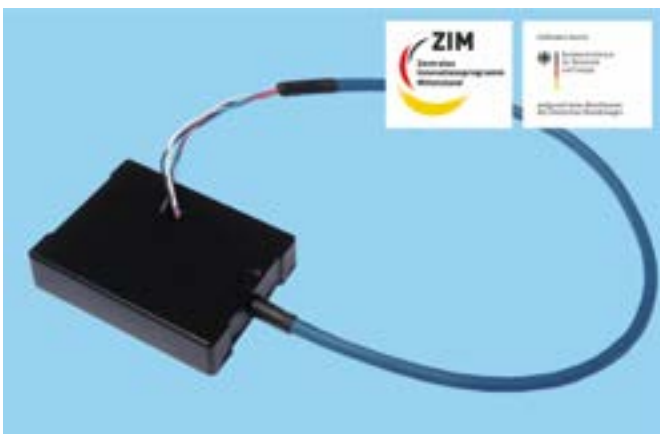

CMSinfra

Conclusion

As a young company we cover a very exciting mix of topics and are keen to see how the wind energy market will develop over the coming years. We are always open to interesting challenges and are receiving more and more contracts from other sectors where we offer development services in the field of CMS especially during the winter months.

A small wind turbine for urban and rural environments

The small wind turbine of the Berlin-based manufacturer enbreeze is economical in its operation and opens up new locations for wind power. Rather than merely scaling down a large turbine, innovative technical solutions were found.

More than six years of development time have gone into enbreeze's small wind turbine. The result is a robust product that is low in maintenance and tailored to the specific wind conditions at ground level. Unlike the usual small wind turbines, the innovative 15 kW turbine operates economically despite its hub height of only 20 metres. On average, it produces 30,000 kWh per year. Because of the simpler approval requirements and low noise emission it is also suitable for urban spaces. As a result, countless sites that used to be unsuitable for wind power are suddenly worth considering.

These could be industrial estates, similar to the company's premises in Berlin-Marzahn where the turbine has been placed directly by the roadside. Since September 2018, it has been providing the company and an electric filling station with environmentally friendly and decentralised energy.

The innovative small wind turbine is particularly interesting for agricultural settings. Farms can become more independent of energy providers, especially when using the turbine in conjunction with a PV plant. With a total height of below 30 metres, the turbine is hardly noticeable next to a stable building. It is not necessary to be in a designated priority area for wind energy to install the enbreeze 15 kW turbine: they can be erected as secondary structures outside of designated areas. Germany thus has innumerable sites where electricity can now be sensibly obtained from wind. Suitable locations might be medium-sized companies, municipalities, research and teaching establishments, or large superstores that want to rely on local power that is generated without emissions. Companies could also use their staff car park to deliver electricity, thus sending a strong signal to support sustainability.

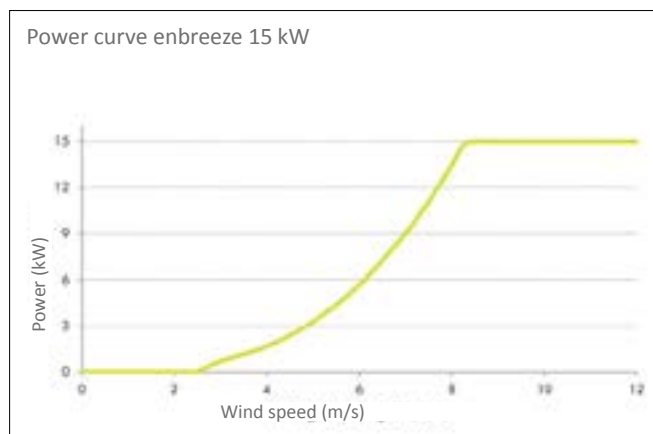



enbreeze
wir leben wind

enbreeze GmbH
Marzahner Straße 34
13053 Berlin
Tel.: +49 (0)30 98 61 27 10
info@enbreeze.com
www.enbreeze.com

Founding year 2009

Staff 10

Focus

- Turnkey small wind turbines for low-wind areas
- System integration and integrated energy
- Project development for small wind turbines
- Decentralised energy supply

We offer

We are your partner in decentralised energy supply from the initial planning approval to the commissioning of your small wind turbine.

We are looking for

We implement your visible contribution to the energy transformation by helping you to supply your farm or company with renewable energy.



The efficient design of the rotor blades is a core feature of the turbine. Because of the low hub height of the enbreeze 15 kW turbine, the rotor blades were specifically designed to cope with variable wind speeds at ground level, setting them apart from large wind turbines. This led to an aerodynamically robust design that is tailor-made for the demands of small wind turbines. The peak efficiency is 52 percent; with less than 45 decibels of noise emission the turbine is also very quiet.

An elaborate pitch regulation system like that in large turbines would be far too expensive for a small wind turbine. enbreeze therefore developed a passive pitch regulation system that sets the aerodynamic forces on the rotor blade against the generating torque. If the generating torque is kept constant once the rated power has been reached, the rotor blades passively pitch out of the wind – turning



by exactly the right degree to ensure the rated power is reached. If the generating power is reduced to zero, the rotor blades automatically pitch out of the wind.

enbreeze GmbH was founded as a start-up in Cologne and today is part of the Berlin-based Elpro Group. The international staff is characterised by its long years of project know-how and innovative ideas.

Conclusion

Small wind turbines have a reputation for being uneconomical. The enbreeze turbine changes this as it was specially designed for variable wind speeds at ground level. Innovative technical solutions bring down operating costs and ensure a good energy yield. Because of its low noise emission, the turbine can even be placed in urban spaces. This opens up countless sites to wind energy that were previously inconceivable. The product can also ensure electricity supply in off-grid areas.

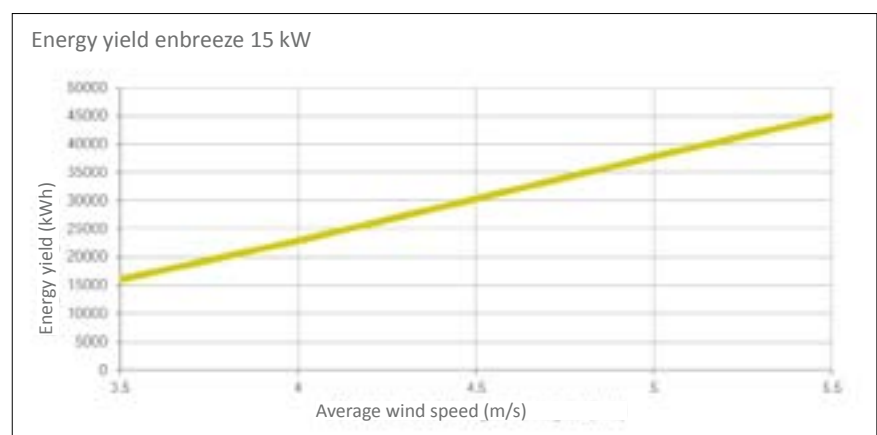

The world's first modular wind energy system: efficient and scalable

One of the biggest technological and economic challenges in the near future is to ensure an energy supply that is not only renewable and environmentally friendly but also economically viable. MOWEA, a Berlin-based start-up, has recognised this challenge and is ready to tackle it head-on.

MOWEA provides flexible modules for scalable wind energy solutions based on the Lego principle. This enables efficient B2B and B2C applications, saving energy costs and bringing down CO2 emissions. MOWEA's aim is to make an effective and economical contribution to achieving global climate targets, inspired by the ambition of becoming the world's first point of contact for flexible, demand-driven wind energy solutions.

MOWEA was founded as a spin-off by Dr Till Naumann and Andreas Amberger, two graduates of Berlin Technical University. Both founders had already focused on wind energy topics during their studies, and were able to successfully merge the research fields of aerodynamics and electrical engineering. It all started with the IBB-ProFit R&D project "Mowian", which successfully validated a method to reduce the costs of small wind turbines: a multi-rotor system consisting of a large number of highly efficient microturbines which can be produced in great numbers. Dr Naumann wrote his doctoral thesis on the aerodynamics of rotor blades with the aim of improving the performance of small rotor blades. He is recognised as an expert and enthusiast in the field of wind energy.





MOWEA GmbH
 Storkower Straße 115a
 10407 Berlin
 +49 (0)30 23526111
 kontakt@mowea.world
 www.mowea.world/de

Founding year	2016
Staff	4
Focus	Energy technology & renewable energy systems
We offer	Efficient, scalable and modular small wind turbines and technical expertise
We are looking for	Industrial project partners, sales partners, production capacities

Motivated by the positive results of the research project, his doctorate and the potential of this technology, he was compelled to explore his vision further. The intensive research that followed was financed by renowned funding programmes, including ProFit funding as well as the EXIST Business Start-up Grant (Federal Ministry for Economic Affairs and Energy, BMWi) with over EUR 1.5 million.

Traditional small wind turbines still lack quality and standardisation, which makes them cost-intensive and expensive. The decisive advantage of MOWEA wind turbines is the scalability of cost-effective, standardised and modular components designed for mass production. Through the innovative use of high-tech, highly efficient aerodynamics and state-of-the-art control technology, MOWEA is setting new standards in small wind turbine technology and reaches top performance values in energy production (certified by Germanischer Lloyd).

MOWEA offers the ideal complement to solar/photovoltaic systems for independent energy supply in industry, real estate and urban areas. The use of several identical small wind generators in one interconnected plug and play technology system ensures high efficiency and allows for flexible applications of the MOWEA systems.



For the market launch, MOWEA has specialised in the field of telecommunications and the application of a modular wind energy system on a telecommunications mast, supported by the expansion of the new 5G radio technology. The company entered a strategic partnership with Vodafone to run a market test and lays claim to two patents. MOWEA is also part of the Vodafone UPLIFT accelerator programme. Large-scale production is planned to start next year.



Conclusion

In summary, it is clear that more green energy is needed globally in order to achieve ambitious climate targets. However, what is still lacking are efficient small wind turbines with flexible application opportunities, which are also cost-effective and can be easily installed and maintained. With its modular and scalable wind energy systems MOWEA offers a solution to this problem.

Location intelligence for the wind energy sector

Digitisation can no longer be ignored by the wind energy sector. In a market that is becoming increasingly competitive, it is more important than ever to respond to market changes early and to use new business opportunities efficiently.

This is where Nefino LI¹ comes into play. Nefino LI is an innovative, cloud-based and scalable geographic information system that benefits a wide range of actors in the global wind energy market. Nefino LI processes comprehensive geographic, wind, turbine and financial data in an integrated system consisting of spatial planning analyses, wind simulations and risk/return calculations. Data are prepared in such a way that users of the software-as-a-service solution obtain relevant information for their decision-making processes. Nefino LI thus enables high-performance analyses of the wind energy market at any spatial scale, ranging from individual wind turbines at the micro-level to large fleets of entire regions at the macro-level.

¹—LI = Location Intelligence

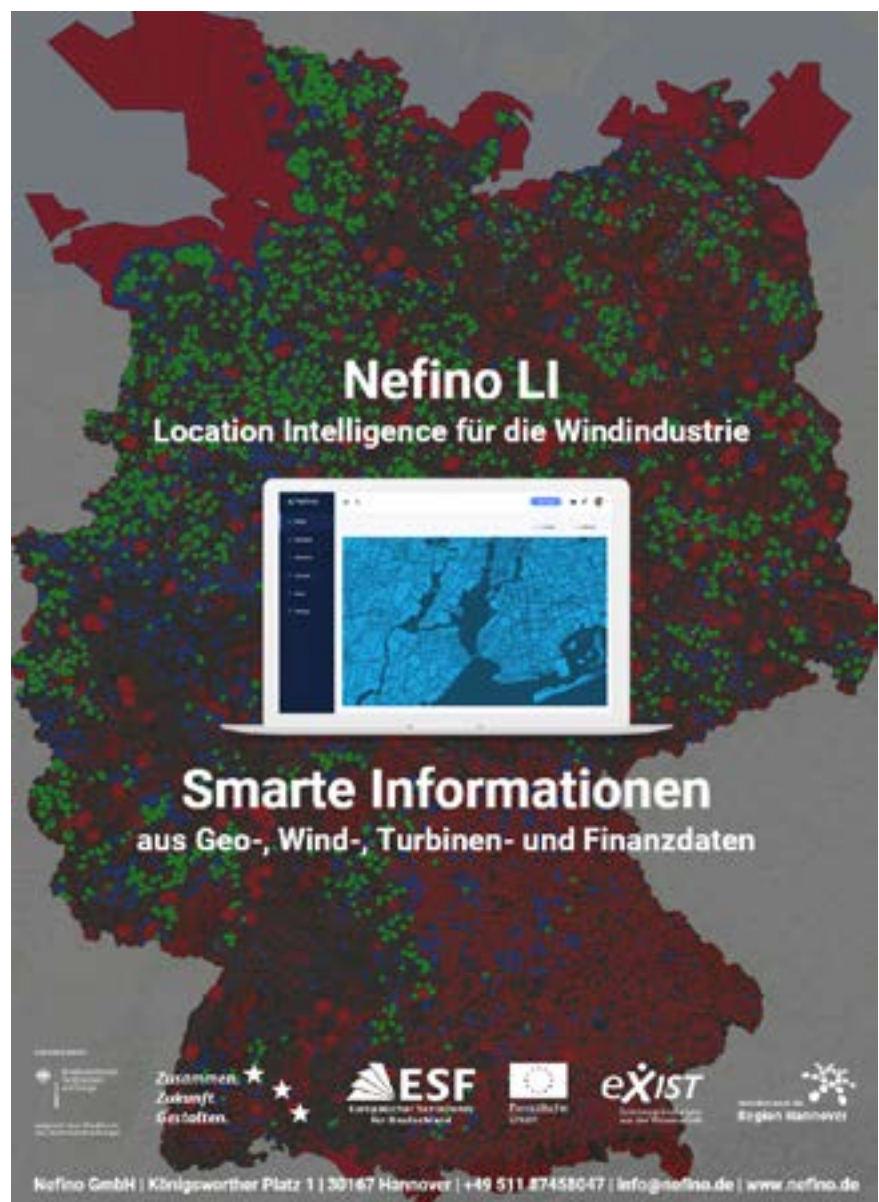

Nefino LI
Location Intelligence für die Windindustrie

Smarte Informationen
aus Geo-, Wind-, Turbinen- und Finanzdaten

Zusammen
Zukunft
Gestalten

ESF
Europäischer Fonds für
Regionalentwicklung

eXIST
EXIST - Excellence in
Sustainable Innovation

Nefino GmbH | Königsworther Platz 1 | 30167 Hannover | +49 511 874580-47 | info@nefino.de | www.nefino.de



Nefino GmbH
 c/o Leibniz Universität Hannover
 Königswortherplatz 1
 30167 Hannover
 Tel.: +49 (0)511 87458047
 info@nefino.de
 www.nefino.de

Founding year	2018
Staff	5
Focus	Software provider, as well as consulting and data analytics services
We offer	Software and analyses to identify greenfield, repowering and decommissioning potential as well as investment opportunities.
We are looking for	Partners interested in joint research projects.

Thanks to Nefino LI, actors such as turbine manufacturers and project planners, banks and investors as well as decommissioning and disposal companies can identify the life cycle phase of specific wind farms in an entire region at any time and anticipate the challenges the respective decision-makers will face in the future.

Users of Nefino LI can thus get a significant advantage in terms of time, information and sales opportunities over their competitors as the system allows them to efficiently identify greenfield and repowering potentials, investment and refinancing prospects, as well as decommissioning and recycling opportunities ahead of their competitors.

On the basis of extensive data specific to wind farms, which are partly collected on site and partly simulated ad hoc in Nefino LI, users of the Nefino LI system are able to proactively approach the decision-makers of wind farms, offering their own smart solutions and supporting them in handling the respective new challenges early and efficiently. In terms of time and cost efficiency, Nefino LI thus provides its users with the crucial first mover advantage which is often decisive in the initial approach to potential customers.

The Nefino LI founders have jointly collected and developed these unique data, models and methods over the last five years as part of their work as research associates at Leibniz University in Hanover. The business idea was born during the project “DemonNetXXL”, funded by the German Research Foundation (DFG), in which the founders analysed the selection criteria and development methods of sustainable and efficient post-utilisation strategies for wind turbines after they had benefited from subsidies under the German Renewable Energy Act (including continued operation vs. repowering).

Since the completion of the research project in September 2018, they have received follow-up funding from the Federal Ministry of Economic Affairs and Energy and the European Social Fund; they have also received an award as a lighthouse project from the Hanover region. With Nefino LI, they are now putting their many years of scientific research into practice, supporting actors in the wind energy market in managing new challenges on the path towards an ecologically and economically intelligent “energy transition 2.0”.



Dr. André Koukal
Co-Founder & CEO



Chris Stetter
Co-Founder & CTO



Jan-Hendrik Piel
Co-Founder & CFO



Martin Westbomke
Co-Founder & CSD

Conclusion

With Nefino LI, Nefino provides location intelligence for the wind industry, setting new standards in the digitised pre-screening of potential areas and operational wind farms. Be it a greenfield or repowering project, an investment or refinancing opportunity or the potential for decommissioning and recycling, Nefino LI lets you specify and take advantage of future business opportunities before your competitors will be able to do so.



Photo: eno energy Group, Paul-Langrock.de



COMPANIES:

Manufacturers of wind turbines

German manufacturers have a high share of the world market, reaching an export rate of 60 to 70 percent. The technology and efficiency of their turbines set standards and are sought-after globally.



ENERCON GmbH

Innovative products and a forward-looking company

Innovative technology, high reliability and good economic viability have characterised ENERCON wind turbines for more than 30 years. The German market leader has erected more than 29,200 turbines with a total rated capacity of more than 50.4 gigawatts.

ENERCON has been one of the technology leaders in the wind power sector for more than 30 years. As the first manufacturer of wind turbines, the company used a gearless drive concept that is a characteristic of all ENERCON wind turbines. ENERCON is also at the forefront in other areas, such as rotor blade design, control technology and grid connection technology, and, with its wide range of technological new developments, proves its innovative strength time and again.

Continual research and development guarantee the ongoing success of the company. The same applies to production and service. All the key components, such as the rotor, annular generators and grid feeding system, are manufactured by exclusive suppliers. This ensures the high

quality and extreme reliability of ENERCON wind turbines. A customer-oriented service offering also plays a part in this, guaranteeing the operator 97 per cent technical availability of the turbines. This holistic concept sets high new standards in technology, quality and safety, and consolidates ENERCON's position as the German market leader.

The product portfolio comprises wind turbines with outputs from 800 to 4200 kilowatts. The latest model is the E-138 EP3 /3.5 MW with a rotor diameter of 138 metres. All ENERCON models boast reliable technology, low maintenance requirements and a long service life, thereby guaranteeing a high level of profitability for customers.





03

Thanks to the directly driven synchronous generator and innovative modular fullscale converter concept, ENERCON wind turbines have a wide range of technical options for adaptation to the grid conditions. They have a grid feeding system that is certified to the latest grid connection requirements. ENERCON wind turbines can therefore be integrated without difficulty into all supply and distribution grid structures. Furthermore, ENERCON wind turbines supply numerous features that support the grid.

True to the company's claim of "energy for the world", ENERCON is driving forward supply with renewable energies worldwide and is also involved in areas of future technology such as energy storage, e-mobility, and smart grid solutions. In doing so ENERCON is expanding its worldwide activities in line with demand. ENERCON has a presence with a global decentralised service and sales network in more than 45 countries.

ENERCON's prudent, sustainable growth strategy guarantees its stability. In autumn 2012, the founding of the Aloys Wobben Stiftung (Trust) sealed ENERCON's stability and independence as well as the continuity of its company direction. On 1 October, Aloys Wobben, company founder and owner, donated his shares of the company to the new foundation to cement the sustainable, future-oriented corporate strategy of ENERCON. Thus, beyond the quality and reliability of the turbine technology itself, ENERCON customers can rely upon a high level of investment security.

- 01 | E-126 EP3 in Kirch Mulsow
- 02 | E-138 EP3 in Wieringermeer
- 03 | E-138 EP3 Wieringermeer rotor blade assembly



ENERCON GmbH

Address **Dreekamp 5
26605 Aurich**
 Phone **+49 (0)4941 927 0**
 Fax **+49 (0)4941 927 109**
 E-Mail **info@enercon.de**
 Web **www.enercon.de/en**
 Category **Manufacturers**
 Profile **Wind turbines**
 Founding year **1984**

eno energy Group

novation for efficiency

Since the company was founded, the name eno energy stands for the highest quality, flexibility and innovation



of experience in plant and component engineering, the eno energy Group not only offers its customers products, but also solutions for individual energy supply strategies, including sector interconnection and active supply management. With branches in Sweden and France, eno is also internationally established.

The company is characterized by flexibility, innovative strength and a high degree of quality awareness; its own research and development as well as close cooperation with specialist engineers, institutes and university facilities are highly valued at eno energy. At its production site in Rostock, the company manufactures wind turbines with rated outputs of 2.05 to 4.8 megawatts and rotor diameters of 82 to 126 meters for the onshore sector. With the eno 114, which is suitable for windy coastal locations, and the eno 126, which is designed for inland locations, the company offers particularly high-performance machines, which have also been available in variants with 4.8 MW output in the IEC II wind class since 2018 through a performance upgrade. The longevity-oriented developments of eno energy systems GmbH are realized exclusively with renowned suppliers.

The eno energy Group is based in Mecklenburg-Western Pomerania since 1999 and has been an established player in the renewable energy industry for 20 years with approx. 800 MW of installed projects. As a manufacturer-independent developer, experienced engineering service provider and wind turbine manufacturer as well as a full-service provider for renewable energy projects starting with turnkey delivery, maintenance and technical-commercial management to long-term asset management, the eno energy Group pursues a broadly diversified business model. With its many years



The areas of service and ease of maintenance, increased efficiency and ensuring high technical performance of the systems and their individual components are of particular importance in times of steadily increasing life-time of wind turbines. With the establishment of local service stations and an operational management, which covers all technical and economic concerns of the plants, reaction times are reduced in the event of a fault, downtimes are minimized and the time availability of the wind turbine is continuously optimized.



For all questions, eno energy has access to an excellent network of consultants, insurers and suppliers, as well as its many years of in-house know-how in all areas of wind energy utilization. This flexibility also makes the company a competent partner for municipal investors and project developers at home and abroad, even with integrated energy solutions.



- 01 | eno 114 in wind farm Brusow
- 02 | eno 114 in wind farm Plauerhagen
- 03 | Nacelle of eno 126
- 04 | Gearbox of eno 114
- 05 | Erection of eno 126

eno energy Group

Adress **Am Strande 2e
18055 Rostock**
 Phone **+49 (0) 38296 746-0**
 Fax **+49 (0)381 203792-101**
 E-Mail **info@eno-energy.com**
 Web **www.eno-energy.com**
 Category **Manufacturers**
 Profile **Wind turbines**
 Turnover **approx. 100 € million**
 Employees **about 200**
 Founding year **1999**

Nordex Group

The Nordex group offers powerful wind turbines for nearly all geographical regions across the globe.

The development, manufacture, project management and servicing of wind turbines in the onshore segment has been the core competence of the Nordex Group and its more than 5000 employees worldwide for nearly 35 years.

As one of the world's largest wind turbine manufacturers, the Nordex Group offers high-yield, cost-efficient wind turbines under the Acciona Windpower and Nordex brands that enable long-term and economical power generation from wind energy in all geographical and climatic conditions.

The focus is on turbines in the 3 to 5MW+ class, and the Group's comprehensive product portfolio offers individual solutions both for markets with limited space and for regions with limited grid capacities.

In September 2017, the Nordex Group launched the N149/4.0-4.5, the first product in the new Delta4000 product series. This was based on the proven technology of the Delta generation turbines successfully installed since 2013 for locations with strong, medium and light wind speeds.

The N149/4.0-4.5 has a variable output of 4.0 to 4.5 MW and can be optimally adapted to the individual specifications of the grid operator, local wind conditions, and noise requirements. This worldwide first installed +4MW turbine was awarded the title of Turbine of the Year 2018" by the trade magazine "Windpower Monthly". In April 2018, the N133/4.8, a variant of this turbine type specialized in strong wind regions, was also launched on the market.

Based on the experience gained with the turbine presented two years ago, already installed and in series production since March 2019, the latest Nordex Group turbine, the N149/5X, was presented in April 2019. With the N149/5X, the company entered the 5MW+ class.





As with the N149/4.0-4.5, flexibility is a key factor in the design philosophy and operating strategy of the new turbine. The turbine covers a wide range of power modes and suitably optimizes in low and medium-wind regions. Depending on the investment criteria of the respective projects, the turbine can be operated flexibly in terms of capacity factor, rating, service life and noise requirements, and thus can also be optimized for the respective business model of the customer.

The Nordex Group can also implement wind farms as part of different project types: from simply selling the equipment, to turnkey projects and complete wind farm development, including the associated project development in certain markets. A global service network, with some 280 service points throughout 30 countries, delivers service quickly to keep our systems running smoothly.



The Group covers the needs of all customer segments within the global wind market, from large energy suppliers, to SMEs operating power plants. Nordex Group systems currently deliver more than 25 GW of sustainable energy each year and can be found in more than 80% of the world's energy market (excluding China).

Nordex SE is listed on the TecDAX of the Frankfurt Stock Exchange (ISIN: DE000A0D6554). The management holding company is headquartered in Rostock, while the executive board and administrative offices are based in Hamburg. At production facilities in Germany, Spain, Brazil, the US, and India, the Nordex Group produces its own nacelles, rotor blades, and concrete towers. The Nordex Group maintains offices and branches in more than 25 countries.



Nordex Group

Address	Langenhorner Chaussee 600 22419 Hamburg
Phone	+49 (0)40 30030-1000
Fax	+49 (0)40 30030-1100
E-Mail	info@nordex-online.com
Web	www.nordex-online.com
Category	Manufacturers
Profile	Wind turbines
Turnover	€ 2.4 billion (2018)
Employees	5,500
Founding year	1985

Siemens Gamesa Renewable Energy GmbH & Co. KG

A market leader in renewable energies

Siemens Gamesa Renewable Energy is a global leader in the wind energy industry. With an installed capacity of around 90 GW worldwide, we produce and install onshore and offshore wind turbines. We also offer a wide range of services.

As one of the most important players and innovative pioneers in the field of renewable energy, Siemens Gamesa has already installed projects in more than 90 countries, employing approximately 23,000 people worldwide. Our broad product portfolio includes both onshore and offshore technologies as well as maintenance and repair services. In Germany, we are represented by Siemens Gamesa Renewable Energy GmbH & Co. KG in Hamburg. You will find sales offices in Kiel, Bremen, Stuttgart, Leipzig and Berlin.

Onshore: complex projects and innovative technology

Siemens Gamesa offers you an extensive range of onshore wind turbines for all wind classes and site conditions. With the Siemens Gamesa 5.X we offer a powerful and technologically leading onshore platform. The new platform comprises two turbine models: the SG 5.8-155 and the SG 5.8-170, the most powerful turbines in our onshore portfolio to date with a rated output of 5.8 MW and rotor diameters of 155 and 170 meters. Both models offer maximum performance in high, medium and low wind conditions. With a diameter of 170 meters, the rotor is the largest in the onshore market. With a highly flexible

design that enables an improved value chain, the platform's versatility makes it suitable for a variety of locations.

The new wind turbines combine proven Siemens Gamesa technologies and offer maximum reliability in operation.

Siemens Gamesa offers an extensive range of onshore wind turbines for all wind classes and site conditions. We are a strong and trustworthy partner when it comes to project implementation, we do not shy away from any challenge and are able to support you with complex projects. For example, three of our customer's modern wind turbines, Hamburg Energie, are located on the premises of Trimet's aluminum smelter in the middle of the port of Hamburg and thus in the direct vicinity of industrial plants. In order to protect industrial production, special protective devices were installed in the wind turbines. These include active fire fighting solutions and an automatic stop of the plant with safe parking position of the nacelle in case of ice release.

Especially for the German market, Siemens Gamesa reaches new heights with its partner, the Max Bögl Wind AG: in Vetschau, the tallest tower to date (165 meters) was installed.



01



02



04



03



05

- 01 | Wehlens Wind Power Plant
- 02 | 2019 ready for series production: the electrothermal energy storage system, ETES, stores energy in hot stones
- 03 | Flying eye: drones support rotor blade inspection
- 04 | In 2018, the most modern production facility for offshore nacelles was inaugurated in Cuxhaven, Germany.
- 05 | Ellhöft Wind Power Plant

Services: digitalization reduces the cost of maintenance and operation

To reduce production downtime due to maintenance work, Siemens Gamesa typically capitalizes digital solutions: thanks to remote diagnosis and algorithm-based operational optimization, our services offer you a decisive plus in cost-effectiveness for your onshore and offshore fleet. In addition, we use the latest digital technologies such as rotor blade analysis using drones or robot maintenance.

We are also constantly working to improve our service offering through innovative and creative solutions and technologies. This also includes the offer to service your entire fleet from a single source. Our engineers and technicians have the ability to maximize the availability of your fleet, regardless of brand, under a comprehensive maintenance contract.

Storage solution: an answer from Hamburg for global challenges of renewable energies

Effective storage solutions are a central building block for the further growth of renewable energy worldwide. Our electrothermal energy storage, ETES, offers a cost-effective solution. We are currently building a demonstrator for this technology, which will store 130 MWh of energy. In the next step, we intend to rapidly expand this technology into the GWh range. For example, existing conventional power plants can be retrofitted with ETES.



Siemens Gamesa Renewable Energy GmbH & Co. KG

Address **Beim Strohhouse 17–31
20097 Hamburg**

Phone **+49 (0)40 2889 0**

E-Mail **info@siemensgamesa.com**

Web **www.siemensgamesa.com**

Category **Manufacturers**

Profile **Wind turbines**

Turnover **€ 9.1 billion**

Employees **23,000**

Founding year **1976**

VENSYS Energy AG

More energy for our future

21,300 wind turbines using VENSYS technology worldwide with 38 GW total rated capacity on the grid.



VENSYS ENERGY develops and manufactures gearless wind turbines with high efficiency for maximum yield. Our trademarks are powerful turbines with a permanent-magnet-excited multipole generator, a maintenance-free toothed belt drive for rotor blade adjustment, simple generator cooling and the full converter system with power generating characteristics.

Our 1.5 to 4.X MW platforms consist of only a few high-quality and durable components. The simple, compact design, low maintenance costs and the advantages of wear-free systems already ensure increased yield thanks to their design.

Customer-tailored wind turbines are developed in an individualised project development – including for small wind farms and the integration of local interests at a community scale, as well as tailor-made supply solutions for companies.

VENSYS provides municipalities and investors with comprehensive, worry-free solutions, from planning tailored to individual cases, to installation and grid connection, to an attractive service package with guaranteed availability for the entire service life.

Production in small series also gives us the flexibility for individual adaptations. Based around the manufacturing concept, our own production at our headquarters in Germany forms the basis for the permanent transfer of developments into VENSYS products. Innovative technologies go hand in hand with solid workmanship, complex quality management and needs-driven short delivery times.

Together with our subsidiaries, we offer an individually scalable complete range of services. The coordinated further development of central turbine components guarantees seamless functionality and higher added value across the entire supply chain and the lifecycle of the turbines. The VENSYS Group's range of services includes full-scale converters and pitch systems, electronic components and network connections as well as network planning, network integration and certification of the turbines. New to the VENSYS Group is in-house manufacturing and continued development of rotor blades. Reliable and profitable at any location. Proven in endurance tests on four continents.

Wind turbines from our German production facilities are connected to the grid in Germany, Poland, France, Great Britain, Spain, Cyprus, USA and Canada. Further markets are being explored, supported by our subsidiary in Poland and VENSYS Inc. in the USA.



04

As the driving force for advanced wind power generation, VENSYS exports its technology worldwide. Our successful licensing model combines innovative technology and made in Germany” know-how with series production, market development and logistics in an internationally operating business network. VENSYS is therefore in a position to implement its own large-scale projects everywhere.

Our most important licensees, Goldwind and ReGen Powertech, manufacture VENSYS turbines as high-growth multipliers for India, China, Asia, USA, South America, Australia and Africa.



02

VENSYS wind energy technology has proven itself on four continents: under a wide variety of climatic conditions, under all network conditions, even in regions with poor infrastructure. Supported by regionally adapted service and customer-orientated support, more than 21,300 turbines with 38 GW are connected to the grid.

Building on the expertise of nearly three decades of innovative engineering, we are already working on pioneering solutions for cold-climate and hybrid turbines, as well as yield-boosting rotor blades.



03

- 01 | VENSYS production facility in Neunkirchen, Germany
- 02 | VENSYS production facility in Neunkirchen, Germany
- 03 | VENSYS headquarters in Neunkirchen, Germany
- 04 | VENSYS training centre in Neunkirchen, Germany
- 05 | Brake: Shipping ten VENSYS turbines to the USA



05



VENSYS Energy AG

Address **Im Langental 6
66539 Neunkirchen**

Phone **+49 (0)6821 9517-0**

E-Mail **vertrieb@vensys.de**

Web **www.vensys.de**

Category **Manufacturers**

Profile **Wind turbines**

Turnover **€ 100 million**

Employees **159 in Neunkirchen,
90 in Diepholz**

Founding year **2000**

COMPANIES:

Suppliers

Manufacturers of wind turbines from all over the world buy systems and components in Germany. Years of experience of the operational side together with specific research and development projects to reduce manufacturing and operating costs and prolong service life are much in demand everywhere.



Photo: Ulrich Mertens



Bachmann electronic GmbH

A secure future for your wind farm

Bachmann offers its customers around the world the most sophisticated automation solutions for the on- and offshore wind sector. To date, one in three wind turbines are equipped with the Austrian company's systems – making them the number one automation specialist for the wind sector.



Bachmann speeds up progress throughout the world in automation technology. As a high tech company our approach to development is systematic and our solutions are fully thought through. This makes us one of the leading automation partners in renewable energies, machine tools and maritime sectors, and the number one automation specialist for the wind sector.

To date, one in three wind turbines are equipped with Bachmann control technology. Our system solutions are open, safe, flexible and modular. Customers confirm our system availability of over 99.96 percent. Integrated condition monitoring and wind farm networking are just two product highlights of Bachmann. Our innovative solutions ensure efficient engineering for your wind turbines:

Operational control

- Turbines – Control/simulation
- SCADA wind farm
- Scalable from a single turbine to a wind farm
- Data models in accordance with IEC61400
- Communication based on standards such as OPC UA

Power quality

- Grid measurement and protection
- Analysis with integrated data recorder
- Static and dynamic grid support
- Grid monitoring in accordance with international grid codes

Wind library/template

- Complete toolbox for turbine development
- Configurable software modules
- Object structure in accordance with IEC61400-25
- Event system and statistical evaluation

Wind farm networking

- Open communication interfaces
- Real-time networking via Ethernet-bluecom
- Standards in accordance with IEC61400-25, IEC61850, IEC60870-xx, DNP3 (and more)
- OPC UA to SCADA & operational control

Condition Monitoring Systems (CMS)

- CMS experience since 1998
- Over 9,000 WTG equipped with CM technology
- The world's first GL certification of a control-integrated CMS
- Customised retrofit solutions

bachmann.

Bachmann electronic GmbH

Address **Kreuzäckerweg 33
6800 Feldkirch, Austria**
Phone **+43 (0)5522 3497 0**
Fax **+43 (0)5522 3497 1102**
E-Mail **info@bachmann.info**
Web **www.bachmann.info**
Category **Suppliers of electrical and
electronic components**
Profile **Controls, cables & switchgear
cabinets**
Turnover **€ 67 million**
Employees **more than 450**
Founding year **1970**



01 | Smart Turbine Automation: Wind turbines must play their part in supplying complex data if they are to be fit for the future. The edge that Bachmann has is the one-source alliance it creates between controller, SCADA, farm control, condition monitoring, da

Bachmann Monitoring GmbH

Have you ever listened to your turbines?

Bachmann creates, develops and manufactures measurement systems for the condition-based maintenance of wind turbines. These systems guarantee a high level of availability and secure investment. Our competence center monitors approximately 6,000 systems of various types and manufacturers.

The core expertise of Bachmann Monitoring lies in measuring and analyzing vibrations. These enables us to closely monitor the health of your onshore and offshore wind turbines. We are monitoring specialists, certified by the Germanischer Lloyd Group and based in Rudolstadt, Germany, and have been supporting wind professionals with our expertise since 1998. We are also part of the Bachmann Group for over 8 years.

Intelligent solutions – The certified remote monitoring service is the key to efficiently monitoring decentralised turbines. Early identification and pinpointing weaknesses spots ensures the reliable operation of turbines and increases yields on a sustainable basis. Condition-based maintenance based on structure-borne sound can be complemented by diagnostic functions, such as rotor blade and structural monitoring, as well as the drafting of expert vibration reports for the wind industry. In addition to condition monitoring solutions (CMS) integrated into control systems, Bachmann also offers standalone CMS.

Our CM systems also enable reliable monitoring of main bearings, for example, the Omega Guard. Certified by Germanischer Lloyd in 2012, this is the world's first, fully control-integrated CMS.

01 | The Bachmann Online CMS-Guard® gives your maintenance staff worldwide access to the condition data. Alternatively, the monitoring experts at the Bachmann Competence Center offer you this demanding task as a service.



This certification is unique in the market to date. All Bachmann CMS meet international standards such as the IEC 61400-25-6, which provides uniformed information for monitoring and control of wind turbines. The compatibility of the information models and information exchange is always guaranteed. It is possible to incorporate CMS extensively into existing network structures and control systems.

International – Among approx. 9,000 equipped wind turbines, Bachmann currently monitors 6,000 onshore and offshore turbines worldwide. Its portfolio encompasses 25 different wind turbine manufacturers of approx. 80 different types ranging from 600 kW to 8 MW.

bachmann.

Bachmann Monitoring GmbH

Address **Fritz-Bolland-Str. 7
07407 Rudolstadt**

Phone **+49 (0)3672 3186-0**

Fax **+49 (0)3672 3186-200**

E-Mail **vertrieb-monitoring@
bachmann.info**

Web **www.bachmann.info**

Category **Suppliers of electrical and
electronic components**

Profile **Condition monitoring systems
Employees more than 50**

Founding year **1998**

Beckhoff Automation GmbH & Co. KG

PC-based control: The universal control platform for wind turbines

With PC- and EtherCAT-based control technology, Beckhoff implements system solutions that have been tried and tested worldwide: more than 55,000 wind turbines all over the world have been automated using Beckhoff technology, each providing up to 8 MW capacity.

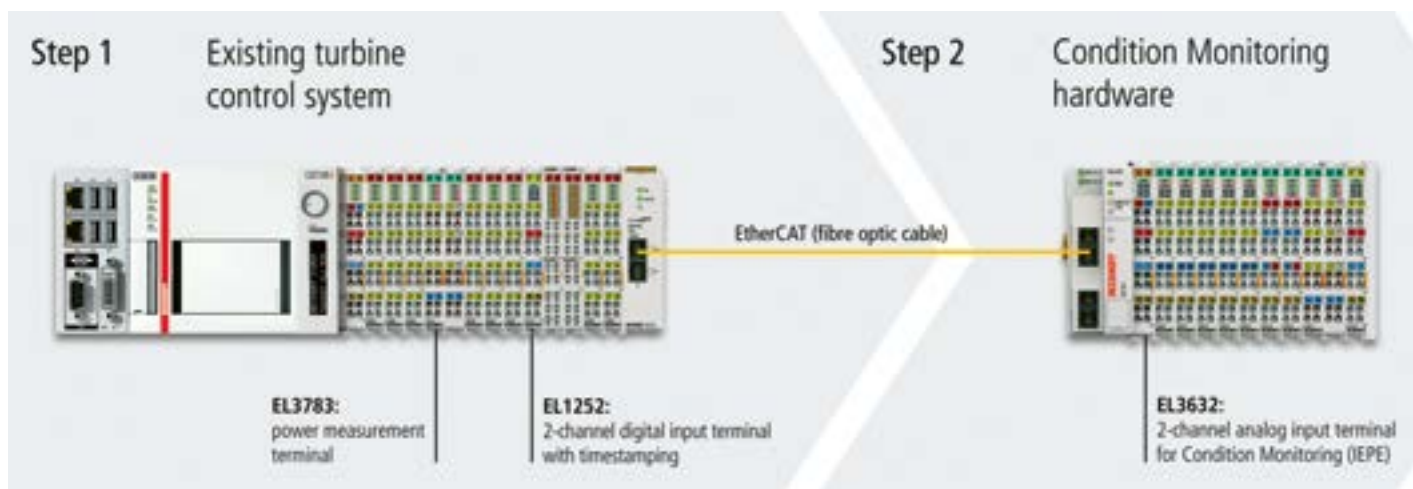

Reliable Condition Monitoring: easily integrated in three steps

An Embedded PC with line-connected I/O modules, EtherCAT as universal communication system and TwinCAT automation software functions serve as the central control system. The modularity of the hardware and software portfolio enables users to configure a controller that exactly matches the performance requirements of their system and allows subsequent extensions and modifications – such as for example a retrofit of Condition Monitoring functions, without great expense.

System-integrated Condition Monitoring

- Time-synchronous data logging in $\ll 1 \mu\text{s}$
- Reliable data analysis
- Enhanced diagnostics
- Increased system availability
- Longer service life of wind turbines
- Reduced maintenance costs
- Reduced system costs
- Enhanced competitiveness

The operation and maintenance of modern wind turbines incurs considerable costs. To maintain competitiveness, operators must minimise failure risks, reduce maintenance costs and increase the availability and energy efficiency of the system. This is where Condition Monitoring enters the game: seamless monitoring of gear units and generators is generally recommended, not just for offshore wind turbines or systems in remote regions, but for all. Beckhoff marries the powerful processors of modern PC technology together with EtherCAT as fast communication system, integrating Condition Monitoring functionality seamlessly into the controller. The vibrations of bearings or electrical machines are picked up by standard measurement terminals from Beckhoff and transmitted to the controller via EtherCAT. Configuration, programming and diagnostics are carried out within one system using TwinCAT.

Step 3

Condition Monitoring software

**System-integrated Condition Monitoring**

With improved error detection and holistic system analysis capabilities, the control system-integrated Condition Monitoring from Beckhoff is superior to conventional hardware-based Condition Monitoring solutions.

High-frequency data acquisition via EtherCAT Terminals

For grid voltage monitoring, two EtherCAT Terminals are available from Beckhoff: the EL3783 power measurement terminal with oversampling function for status monitoring in a 3-phase AC network, and the EL1252 digital input terminal with timestamp function for the chronologically precise detection of binary control signals.

The retrofit of a wind turbine with Condition Monitoring can be realised by simply adding a terminal block with the corresponding EtherCAT measurement terminals to the turbine controller. A multi-functional input for analog measurement technology is available in the EL3751 EtherCAT Terminal. The EL3632 enables the direct connection of various acceleration sensors via an IEPE interface and performs high-precision vibration measurement. Strain gauges (SG) can be evaluated via the EL3356-0010. The raw data are recorded synchronously ($\ll 1 \mu\text{s}$) with other system data, such as power and speed, which increases the reliability of the data and reduces the number of false alarms. A modular tool kit of mathematical algorithms for the analysis of measured values is available in the TwinCAT Conditioning Monitoring library. The library provides all essential functions for analysis, statistics and classification. Combining these algorithms with limit value monitoring is for instance, ideally suited to monitoring roller bearings.

We also recommend the utilisation of special solutions from established third-party vendors, which can be directly integrated into the Beckhoff control platform, giving users access to extended diagnostics capabilities, reports, and long years of experience of these providers in consulting regarding monitoring.

If component-related threshold values are exceeded, the Condition Monitoring system triggers alarms to inform about wear, imbalances or impermissible operating states. In addition, the continuous machine monitoring can be carried out online. Trends in the characteristic values are analysed and translated into recommendations for action, for example in the planning of maintenance intervals.

BECKHOFF**Beckhoff Automation GmbH & Co. KG**

Address	Wahmstr. 56 23552 Lübeck
Phone	+49 (0)451 203988-0
Fax	+49 (0)451 203988-20
E-Mail	wind@beckhoff.com
Web	www.beckhoff.com/wind
Category	Suppliers of electrical and electronic components
Profile	Controls, cables & switchgear cabinets
Turnover	€ 916 million (2018)
Employees	4,300
Founding year	1980

Balluff GmbH

Sensor and automation solutions for the wind turbine and its manufacture

Together, digital, networked – these three buzzwords are indicative of the path which Balluff has chosen and which the company consistently implement in project partnerships when developing new customer solutions.

Balluff is represented in 68 countries with 4,000 employees and stands for innovative technology, quality and maximum customer orientation around the world. As a leading solutions provider for industrial automation, the family-owned company in its fourth generation offers a comprehensive product range for use in wind turbines and in manufacturing:

- Sensors
- Rotary and linear position sensing
- Identification solutions with RFID systems and cameras
- comprehensive program of high-end networking and connection technology for high-energy industrial communications



BALLUFF

Balluff GmbH

Address **Schurwaldstr. 9
73765 Neuhausen**
Phone **+49 (0)7158 173-0**
Fax **+49 (0)7158 5010**
E-Mail **bernd.schneider@balluff.de**
Web **www.balluff.com**
Category **Suppliers of electrical and
electronic components**
Profile **Sensors**
Turnover **€ 488 million (2018)**
Employees **4,000**
Founding year **1921**

- 01 | Examples from the product portfolio
- 02 | The Balluff Testing Laboratory is accredited by the German National Accreditation Body DAkkS for the testing of electromagnetic compatibility.
- 03 | All the sensors used are HALT (High Accelerated Lifetime Tests) tested and ensure the best possible and reliable control of wind power equipment

DAFA Deutschland GmbH

80 years experience in the development, production and sale of foam, rubber and plastic products DAFA Wind solutions are developed using our experience within every field of business to your advantage in wind power.

Foam, rubber and plastic solutions – seal, absorb and protect

DAFA is a Danish family company with more than 80 years of experience in the development, production and sale of special foam, rubber and plastic solutions.

DAFA Wind

Our objective is to combine innovative sector-specific solutions. DAFA Wind includes products that have been developed using our experience from every field of business for your advantage in wind power.

Nacelle

DAFA's nacelle solutions help structures and electronic components in the nacelle to withstand stress, to perform better and thus to last longer. Optimise your products using our solutions within sealing, mounting and acoustics.

Rotor blades

Our foam and rubber solutions help from the very beginning; enhancing the blade design so it lasts longer and assuring safe transportation from the factory to the construction site. DAFA's solutions are on hand for de-icing solutions and maintenance tasks as well.

01 | DAFA RotaSeal®

02 | DAFA CargoPro® Strap Pad

03 | DAFA Tip Protector



DAFA CargoPro®

CargoPro is a range of innovative and protective solutions for transport and storage of blades, towers and equipment for wind turbines. CargoPro is particularly suitable for transport and storage of wind turbine blades and consist of a range of tested and proven rubber mats and foam solutions.

DAFA RotaSeal®

Your best choice in protecting rotating components in the turbine against penetration of salt, sand, water or dust. Use RotaSeal to meet demanding requirements for the hub or tower.

DAFA Tower Foundation System

Formwork elements matching requirements guarantee low tolerances and safe processes on the construction site. By using the Tower Foundation System you achieve a noticeable increase in the efficiency of the formwork.



DAFA Deutschland GmbH

Address **Am Oxer 7
24955 Harrislee**

Phone **+49 (0)461 5749 8536**

Fax **+49 (0)461 5749 85369**

E-Mail **info@dafa-germany.de**

Web **www.dafa-as.com**

Category **Suppliers of mechanical components**

Profile **Seals & vibration control**

Employees **350 worldwide**

Founding year **1939**

DEUBLIN GmbH

Be More.....

Providing the worldwide preferred solutions for reliable media transmission between nacelle and hub.



Since more than 20 years DEUBLIN stands for reliable media transmission between nacelle and hub in wind turbines. DEUBLIN design and manufacture precision rotating unions and electrical slip rings globally on four continents, North America, South America, Europe and Asia. 550 employees work dedicated to satisfying customer demands with fully developed and customized solutions.

Highly qualified engineers located in 17 subsidiaries facilitate projects worldwide from enquiry through to first assembly. Superb products, high quality standards and the worldwide organization enable DEUBLIN to be the preferred first tier supplier to the wind industry.



The Rotating Union is a precision mechanical component which allows the transfer of pressurized fluids from stationary systems to rotating machinery.

The electrical slip ring is providing electrical power to the hub and interchange data and signals between the components and the electrical cabinet.

To DEUBLIN, **being a partner in the wind industry** means utilizing only specialized solutions that can meet highest expectations in terms of reliability and longevity. The rotating union and electrical slip ring are critical components in the wind turbine pitch control system.

Quality Environmental standards according to ISO 9001 and ISO EN 14001 are a cornerstone of our corporate culture. Deublin is an Authorized Economic Operator (AEO) offering lean logistic operation and secured customs clearance.



DEUBLIN GmbH

Address **Florenzallee 1
55129 Mainz**
Phone **+49 (0)6122 8002-0**
E-Mail **aschubert@deublin.de**
Web **www.deublin.eu**
Category **Suppliers of mechanical components**
Profile **Hydraulic components**
Employees **550**
Founding year **1945**



Gram & Juhl A/S

Predict the future and get a complete overview of your turbines

The world's leading supplier of condition monitoring systems for wind turbines with more than 20 years of experience in vibration analysis. Gram & Juhl uses machine learning to optimize maintenance of wind farms all over the world.

With close to 25,000 wind turbines embedded with the TCM® (Turbine Condition Monitoring) technology, Gram & Juhl has set new standards in vibration measurement.

Gram & Juhl offers a worldwide monitoring service and a cost-effective retrofit solution that can effectively increase the turbine's annual energy production, and extend the turbines lifetime.

Gram & Juhl is watching your wind turbines

Gram & Juhl is watching your wind turbines so you can protect your assets and reduce your operation cost. The TCM® Monitoring Service will optimize maintenance, and minimize downtime.

By detecting evolving damages in structural or rotating parts in an early stage, you can prevent severe equipment failures and expensive repairs. Knowing when to take action, you can schedule repairs and plan for optimal maintenance, driving down the cost of energy.

Based on years of experience, machine learning algorithms are developed and applied, which support the damage analysis and make it even more reliable.



Increase uptime and extend turbine lifetime with TCM® retrofit

The TCM® Wind Turbine Retrofit solution, can effectively increase the turbine's annual energy production, and extend the turbine's lifetime. Gram & Juhl has extensive experience and know-how, from a massive number of retrofit solutions around the world.

With the TCM® retrofit kit, CMS can now be economically feasible even for older wind turbines.

Preventive and predictive maintenance will reduce your LCoE and enable you to achieve maximum availability.

That is why Gram & Juhl's mission is to **KEEP THEM TURNING!**



- 01 | Gram & Juhl are monitoring wind turbines all over the world
- 02 | With the help of machine learning Gram & Juhl is able to foresee when turbine components are malfunctioning and need maintenance.
- 03 | Gram & Juhl has extensive experience and know-how, from a massive number of retrofit solutions around the world.

GRAM & JUHL

Gram & Juhl A/S

Address	Technologiepark 4 26129 Oldenburg
Phone	+49 (0)441 779 313 45
E-Mail	sales@gramjuhl.com
Web	www.gramjuhl.com
Category	Suppliers of electrical and electronic components
Profile	Condition monitoring systems
Employees	34
Founding year	1997

HELUKABEL GmbH

The professional cable solution for the wind energy sector

HELUKABEL GmbH is one of the leading international suppliers and manufacturers of cables, wires and accessories. We provide optimised and individualised solutions for every application in wind turbine installation.

We will advise you on:

Nacelle: Cables with increased oil- and heat-resistance, special solutions for the slip ring

Loop: All torsion cables are tested for 18,000 cycles in our test-tower

Tower: Copper and aluminium cables, multi-wired and fine-wired, special lift cables, fibre optic cables and fastening systems



HELUKABEL GmbH

Address **Dieselstr. 8-12
71282 Hemmingen**
Phone **+49 (0)7150 92090**
Fax **+49 (0)7150 81786**
E-Mail **info@helukabel.de**
Web **www.helukabel.de**
Category **Suppliers of electrical and
electronic components**
Profile **Controls, cables & switchgear
cabinets**
Turnover **€ 502 million (2016)**
Employees **1,200**
Founding year **1978**



All requirements regarding climatic conditions from -55 °C to +145 °C, offshore applications, high fire-testing parameters as well as international approvals according to UL, CSA, FT4, CE, VDE and WTTC standards can be met. These also include requirements regulating the North American market in compliance with the new UL 6141/UL 6142 standards. The Traycontrol cable series and an extensive portfolio of UL-listed products are available in stock. Our top of the line model in the area of wind power is the WK 137-Torsion FT4 cable. It satisfies all the requirements of wind turbine manufacturers such as, increased nominal voltage of 1000 V, UL/CSA approval over a large temperature range without the use of halogen, and the demanding FT4 fire test of the CSA.



With its WK POWERLINE ALU cable, HELUKABEL is continually increasing its lead as a supplier of innovative products for the wind power industry. Thanks to its low weight and highly flexible design, aluminium conductors are closing a critical gap in power cabling. The specially developed connection equipment completes the product range.

Interhydraulik company for hydraulic components with limited liability

Development – Production – Service: Expertise under one roof

As a specialist in hydraulic connecting technology, Interhydraulik offers a diverse range of pipelines, hose assemblies and screw connections for use in wind turbines.

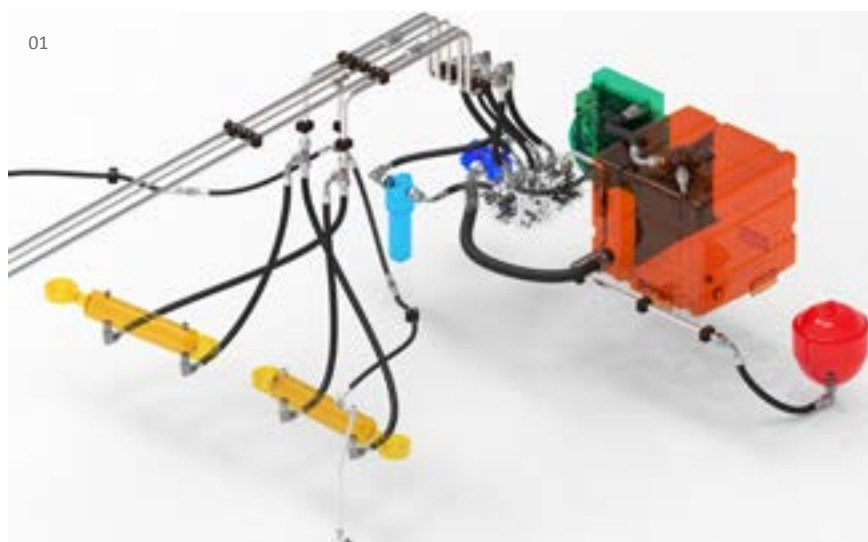

Due to increasing power density and ever-decreasing gap dimensions, technical cleanliness should not be underestimated for the long-term reliability of hydraulic systems. We meet the requirements of various OEMs regarding the **cleanliness** of hydraulic components. This is why we have our products and manufacturing processes audited by independent institutes.

- 01 | Construction of complete hydraulic connection technology to your 3D model
02 | Exemplary tube plan of gearbox for lubrication of transmission bearings

We have been developing, manufacturing and distributing components for hydraulic connecting technology since 1984. As an owner-operated family business with over 190 employees around the world, today we are one of the leading system providers for hydraulic components in the fields of **mobile hydraulics** and **wind energy**.

Our passion for our customers' technical problems sets us apart. Our application technology means we can quickly develop **individual and intelligent product solutions** to a problem. Every project is supported from the development of the prototype to series production.

Our quality, experience and passion is not limited to mobile hydraulics. Our customers also include reputable companies in the field of wind energy, which have been using our products for many years all over the world.

Our products are also used on the **inside** and **outside of gearboxes**.

Inside the gearbox: Pipelines, lubrication lines, nozzles, oil reservoirs, distributors, holders

Outside the gearbox: Hose assemblies and pipelines, intake manifolds, distributors, compensators, special components, pre-assembled components

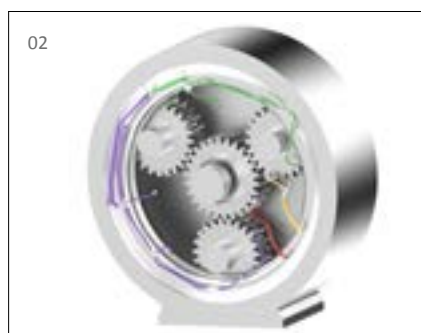

Interhydraulik company for hydraulic components with limited liability

Address	Am Buddenberg 18 59379 Selm
Phone	+49 (0)2592 9780
Fax	+49 (0)2592 978100
E-Mail	info@interhydraulik.de
Web	www.interhydraulik.com
Category	Suppliers of mechanical components
Profile	Hydraulic components
Turnover	€ 22.8 million
Employees	190
Founding year	1984

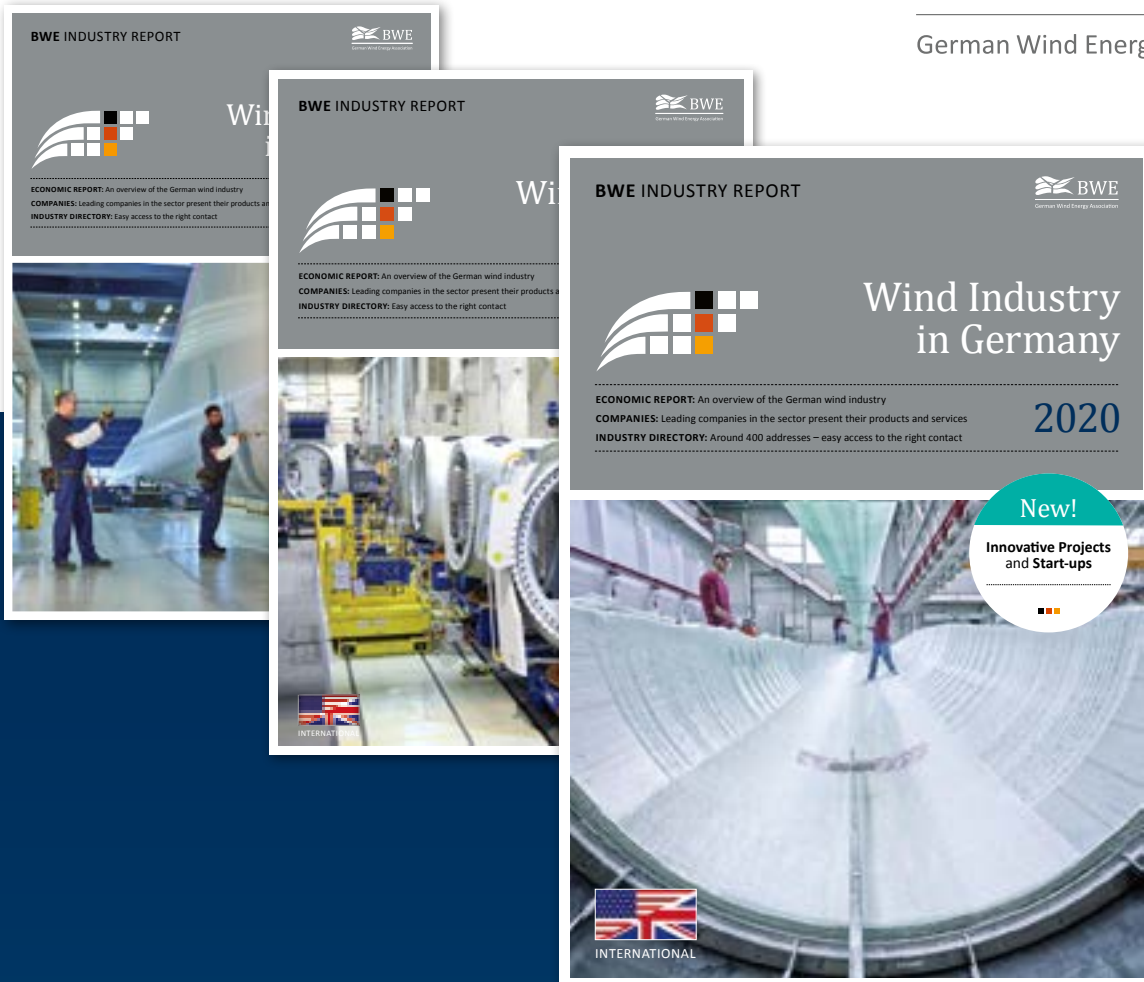

Published in
German and
English.

The Who's Who of the German wind industry

Your company is not listed in the publication?
You'd like to be included again next year?
Then don't hesitate!

Specification:

- Company profile and/or Address entry in the printed Industry Report
- Free distribution around the world at trade fairs and conferences
- Your entry in the two online industry portals www.windindustry-in-germany.com and www.wind-turbine.com
- Editing and graphics of your company profile
- Free copies for your own marketing

We'll be glad to advise you:
Branchenreport@wind-energie.de

 Windindustry
in Germany

Next release date:
September 2020

LAPP

From the nacelle through the tower to the network connection

Fully integrated solutions: with LAPP, the wind power industry can fulfil all its cabling needs from a single provider.

Stuttgart-based LAPP is a leading supplier of integrated solutions and branded products for cable and connection technology. With brands such as ÖLFLEX® (connection and control cables), SKINTOP® (cable glands) and EPIC® (industry connectors), we offer absolute quality products and complete system solutions which meet the highly demanding requirements of wind turbine manufacturers. Ready-to-fit ÖLFLEX CONNECT systems are manufactured at the same high quality all over the world.

With our own, state-of-the-art test centre, we make sure that our products are of the highest quality. Thus LAPP customers can be sure that systems function reliably with minimum downtimes. For this purpose, LAPP operates a unique 16-metres-high test facility, in which cables up to 12 metres in length can be tested under realistic conditions as found in the loop of a wind turbine.

This type of test facility where all fastening points for cables and conductors exactly match real-life conditions only exists in one other location in Europe.

Specifically for the wind energy sector we have developed and tested cables which are flame-retardant, halogen-free and torsionable and which cover a wide range of temperatures. In combination with the SKINTOP® cable glands, which provide unrivalled vibration protection, we offer a product portfolio that perfectly meets the industry's highly demanding requirements. Many of our products comply with common international standards.

With our own production sites in Europe, Asia, the USA and a network of sales offices and logistics centres on six continents, we are always available to our customers wherever they are in the world – always working fast and to the same high quality standards.



01 | In LAPP's unique test facility cables up to 12 metres in length are tested under realistic conditions



U.I. LAPP GmbH

Address **Schulze-Delitzsch-Strasse 25
70565 Stuttgart**
Phone **+49 (0)711 7838-3175**
Fax **+49 (0)711 7838-7330**
E-Mail **andreas.mueller@lappkabel.de**
Web **www.lappgroup.com**
www.lappkabel.com
Category **Suppliers of electrical and
electronic components**
Profile **Controls, cables &
switchgear cabinets**
Turnover **€ 1,153 million (consolidated)**
Employees **4,245**
Founding year **1959**

Max Bögl Wind AG

Using renewable energies efficiently.

We are manufacturer of the world's highest hybrid towers for wind turbines and set new standards in the storage of renewable energies with our Water Battery. As a turnkey partner for wind and energy projects, we also offer an economical full-service package right through to the finished wind farm.



Max Bögl Wind AG

Address **PO Box 11 20
92301 / 92369 Neumarkt i. d.
Opf.**

Phone **+49 (0)9181-909-0**

E-Mail **wind@max-boegl.de**

Web **www.mbrenewables.com**

Category **Suppliers of large components**

Profile **Towers**

Turnover **€ 1.7 billion**

Employees **6,500**

Founding year **1929**

We are specialized in manufacturing and erecting hybrid towers and we hold the record for the world's tallest wind turbine. By combining prefabricated, CNC-milled concrete elements with standard steel tube sections, our modular hybrid towers can reach hub heights of up to 190 meters. The conical shaped concrete elements are series-produced in our precast plants at the Sengenthal headquarters and in Osterrönfeld in Schleswig-Holstein. Thanks to the ideal access to waterways, the hybrid towers can also reach their destination quickly and safely throughout the EU. For international projects, we use our Mobile Fabrication in which the concrete elements are produced with regional workers and local raw materials.

We are also setting new standards in the field of energy storage with our Water Battery. This flexible short-term storage facility combines renewable energies with a modern pumped-storage hydropower plant.

As an experienced turnkey partner, we also support our customers in all project processes - right up to the complete construction of entire wind farms.

Qualified employees advise and support our customers with efficient concepts for all services. We see ourselves as a competent partner - from the initial idea through financing, planning and execution to the operation of the turbines. Our services also include technical and commercial management and the development of individual energy concepts.

As a subsidiary of the Max Bögl group, we are one of the TOP 10 companies in the German construction industry with over 6,500 specialized employees at 35 locations worldwide and an annual turnover of over 1.7 billion euros.

01 | The Hybrid Tower – Highest performance

02 | Turnkey partner for wind and renewables projects. Credit: M. Rebel

03 | The Mobile Fabrication for international use.

04 | The Water Battery – Storage power

NGC Transmission Europe GmbH

Experts in excellent gearbox solutions

NGC is a market leader in wind turbine gearboxes and one of the world's leading suppliers of drive technology.

Quality products for any application

NGC develops, produces and distributes main gearboxes and pitch and yaw drives for multi-megawatt wind turbines. Our products meet the highest quality standards and are designed for both onshore and offshore applications, as well as for use in temperature ranges of $-40\text{ }^{\circ}\text{C}$ to $+50\text{ }^{\circ}\text{C}$.

NGC standard series – the economically viable alternative

Minimise costs, reduce risks, shorten development times, simplify service and maintenance – you can achieve all this with our StanGear series, which we offer as an alternative to our customer-specific solutions.



Service without the ifs and buts

We provide customised servicing and maintenance concepts for your specific needs in order to guarantee the high quality and sustained efficiency of our gearboxes during operation.

High availability through global presence

Engineering, sales and other services are available right around the world. In addition to our headquarters in Nanjing, China, NGC is also present in Europe, the USA, India and Asia-Pacific region.

Experience and expertise – the key to our success

NGC has been providing gearbox solutions for 50 years and, in this time, has successfully installed over 55,000 main gearboxes and more than 300,000 pitch and yaw drives in over 30 countries. Experience and expertise, in addition to state-of-the-art technology, continue to be the essential cornerstones of our gearbox technology.



NGC Transmission Europe GmbH

Address **Schifferstr. 196
47059 Duisburg**
Phone **+49 (0)203 509 600 0**
Fax **+49 (0)203 509 601 90**
E-Mail **wind-eu@NGCtransmission.com**
Web **www.NGCtransmission.com**
Category **Suppliers of mechanical
components**
Profile **Gears**
Founding year **2014**

Nidec SSB Wind Systems GmbH

Together, we offer more! One-stop shopping with SSB Wind Systems

As a pioneer in wind energy, we already have decades of experience with electric pitch systems. With the support of Nidec, we have significantly expanded our product range related to wind energy. According to company's philosophy: "Nidec: for everything that turns and moves."

For flexible, cost-efficient components or system solutions

Since 1990, we have offered our technology and know-how for onshore and offshore solutions:

- Pitch systems (750 kW to 10 MW)
- Switch and control cabinets
- Service (training, support)
- One-stop shop: multivendor capability for all accessories and spare parts for all electrical pitch systems

Perfectly in tune: Our pitch systems

Designed to fulfill your individual requirements and your wishes for all WTGs, a large part of our system is comprised of the Perfect Pitch Drive as well as the Perfect Pitch Interface applications module. Our new system offers you maximum

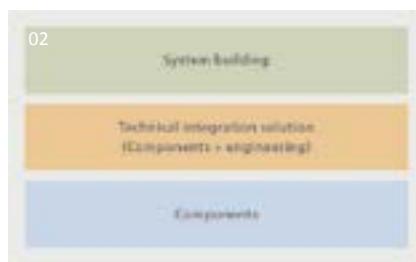

freedom to choose. You can select individual components, engineering support or the very best of both as a complete system solution. We are available to advise you at every step in order to create the perfect solution to your needs:

- Perfectly aligned motor-inverter combinations
- Added value due to our engineering services: perfectly adapted to your turbine as a whole
- Perfect as always: our comprehensive system solutions – turnkey / pre-finished for your turbine

One-stop shop: multivendor capability for all accessories and spare parts for all electrical pitch systems

We not only supply components and spare parts throughout the entire lifecycle for our own systems. You are missing a spare part for a pitch system of another supplier? Talk to us - we'll deliver a perfect solution for you.

Highest quality service: at eye-level

We don't just develop and build pitch systems. We maintain them too. Our service teams support you with commissioning, on-site services and spare parts procurement for all systems we deliver. Additionally our service offer includes the training of your service technicians and installers.

Nidec
All for dreams

SSB Wind Systems
Be consistent.

Nidec SSB Wind Systems GmbH

Address **Neuenkirchener Strasse 13
48499 Salzbergen**

Phone **+49 (0)5976 946-0**

Fax **+49 (0)5976 946-139**

E-Mail **info.ssb@mail.nidec.com**

Web **www.ssbwindsystems.com**

Category **Suppliers of electrical and electronic components**

Profile **Controls, cables & switchgear cabinets**

Employees **300 worldwide**

Founding year **1970**

COMPONENTS FOR WIND TURBINES

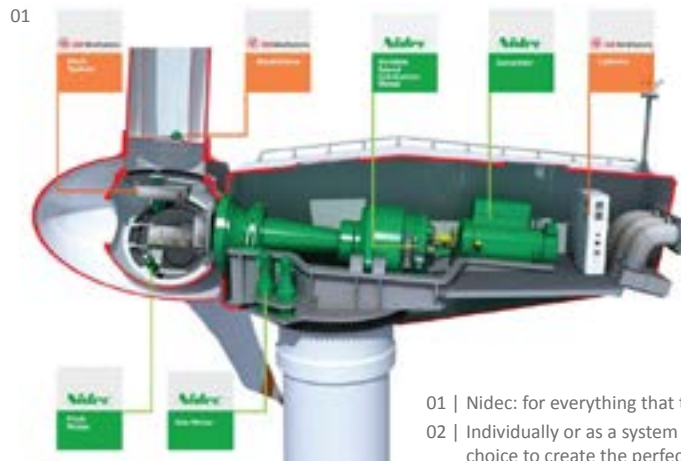

01 | Nidec: for everything that turns and moves

02 | Individually or as a system – it's your choice to create the perfect solution

NSK Deutschland GmbH

Partnership based on Trust - Trust based on Quality

For over 15 years NSK has been a partner of the wind industry and one of the main suppliers of roller bearings for wind energy gearboxes and bearings for main rotor shafts and generators.

Combined know-how

Skills from sales and application technology are combined in the wind energy team – and also include the latest research results from our technology centres. Bearings are specifically designed using highly developed calculation and simulation tools. Our experienced engineers take account of load cycles, lubrication, deformation, thermal response and also extreme and maximum conditions. This is the only way to produce a construction with cost-optimised components that also reliably function under maximum loads and have a long service life.

NSK wind standard

As the first manufacturer, NSK defined the pioneering wind standard U303 for roller bearings back in 2008 – including a one hundred percent traceability of the components of every single bearing and all essential processes. NDT methods (non destructive testing) are also available to avoid grinding burn, fractures in material and structural breakdowns.



Long service life with BOC (black oxide coating) and patented materials

BOC treatment of bearings prevents untimely bearing failures caused by white etching cracks (WEC). The patented special material AWS-TF (anti white structure-tough) is also available for high-level requirements and reliably prevents damage caused by WEC. Our STF material (super-tough) has proved ideal when it comes to increasing the load rating and service life, especially for contaminated lubricants. Certification by DNV GL confirms: Using Super-TF material means that the basic dynamic load rating can be improved by 23 % in roller bearings, and 26 % in ball bearings. This is equivalent to a doubling of bearing fatigue life.

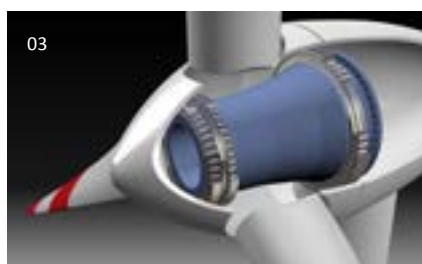

01 | Main gearbox for wind turbines
02 | Planet wheel gear and bearing
03 | Main rotor shaft bearing

MOTION & CONTROL™
NSK

NSK Deutschland GmbH

Address	Harkortstrasse 15 40880 Ratingen
Phone	+49 (0)2102 481-0
E-Mail	info-de@nsk.com
Web	www.nskeurope.com
Category	Suppliers of mechanical components
Profile	Bearings
Turnover	Global: about 991 billion Yen (as per March 2019)
Employees	Global: 31,484 (as per March 2019)
Founding year	1916

perma-tec GmbH & Co. KG

perma – The Expert in Lubrication Solutions

Wind energy plants are exposed to mechanical loads, vibrations, and moisture penetrations. To ensure reliable operation over long periods, moving components require maintenance and permanent relubrication. For this purpose, perma offers automatic lubrication solutions.



Tip: perma STAR lubrication systems are also well suited for lubrication, as these can give feedback signals visually or to higher controls.

Utilise the benefits of perma lubrication systems

- No manual lubrication with a grease gun
- Continuous lubrication while system is running
- Lubrication systems with the right lubricant for every lubrication point
- Less time spent in hard-to-access areas
- Reduction in accidents due to slipping hazard
- Reduction of lubricant consumption with needs-based metering
- No lubricant contamination thanks to enclosed systems

Tried and tested a million times over: perma lubrication systems in wind turbines

perma lubrication systems reliably provide wind turbines with lubricant during operation. Components such as blade bearings, blade gear teeth, main- and yaw bearings, yaw gear teeth, and roller bearings on the generator are lubricated.

perma FUTURA PLUS – the complete system for instant use

perma FUTURA PLUS has been especially developed for use in wind turbines and comes ready to be used. You can order the lubrication system with the desired discharge period and the ideal lubricant for the respective lubrication point. The activation is started by turning the activation cap. perma FUTURA PLUS will provide lubrication points with lubricant for up to 12 months. This saves time, extends maintenance intervals, and relieves the service personnel.

perma lubrication systems increase the economic efficiency of wind turbines

- Reduction of maintenance costs and service expenditure
- Projectable maintenance intervals
- Fewer bearing failures

We are sure that the performance of our perma lubrication systems will convince you!

For more information go to www.perma-tec.com

perma-tec GmbH & Co. KG

Adress **Hammelburger Str. 21
97717 Euerdorf**
Phone **+49 (0)9704 609-0**
Fax **+49 (0)9704 609-50**
E-Mail **info@perma-tec.com**
Web **www.perma-tec.com/en**
Category **Suppliers of mechanical components**
Profile **Lubricants & lubrication systems**
Turnover **€ 90.5 million (not consolidated)**
Employees **253**
Founding year **1934**



01 | Automatic relubrication of the generator bearing

02 | Blade bearing lubrication

Prysmian Kabel und Systeme GmbH

Harnessing the wind of change.

The Prysmian Group is the world's leading manufacturer for cables for the segments energy, telecom, data and industrial.

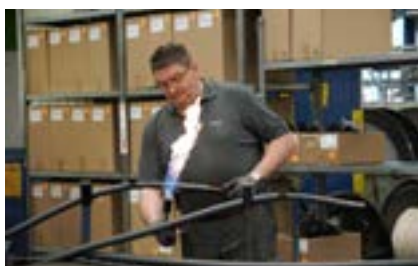

Its certified quality management with a worldwide focus ensures that product quality is always at the highest level, from the procurement and production processes, right through to the delivery process. With a focus on sustainable and environmentally friendly production processes, the Prysmian Group ensures that the fundamental principles of sustainable energy concepts are also implemented in its own company.

Our integrated management system complies with DIN EN ISO 9001, IRIS, ISO/TS 16949, KTA 1401, DIN EN ISO 14001, DIN EN ISO 50001 and OHSAS 18001. These are regularly monitored by independent experts.

As a world leader in special cables for wind turbines, we are able to manufacture products for the wind industry for all voltages or, if required, fully assembled cable sets in our German and international production sites:

Nacelle / Loop

Special cables (optional halogen-free / flame retardant) with increased oil, heat and ozone resistance, as well as optimized torsion properties, up to 66 kV.

Tower

Special cables (optional halogen free / flame retardant) for fixed installation with copper or aluminium conductors with excellent installation properties, up to 66 kV.

Wind farm cabling

From the low- and medium-voltage cables for the wind farm infrastructure, through to the high-voltage grid, we supply all cables for onshore and offshore applications.

In addition, we are able to supply cables as pre-assembled cable sets, as well as a service for fitting / commissioning or maintenance / turbine monitoring.

Prysmian Group

Prysmian Kabel und Systeme GmbH

Adress **Alt Moabit 91 D
10559 Berlin**
Phone **+49 (0)30 3675 40**
Fax **+49 (0)30 3675 4571**
E-Mail **kontakt@prysmiangroup.com**
Web **www.prysmiangroup.com**
Category **Suppliers of electrical and
electronic components**
Profile **Controls, cables & switchgear
cabinets**
Turnover **€ 11 billion**
Employees **30,000**
Founding year **1879**



QV LUX GmbH

The World's First System for On-Demand Night Lighting during Regular Operation
With SCANTER 5XXX, QV LUX offers a radar-assisted system for the on-demand night lighting of wind farms – and it is the first such system in the world to be approved for ten-year regular operation. QV LUX is a joint venture between Green Wind and VOSS Energy.



Tried-and-True Night Lighting for Major Projects

Based in Brandenburg, QV LUX is able to supply, install, operate, and maintain a complete on-demand night lighting system for wind farms, based on the successful pilot project in Groß Woltersdorf (Brandenburg). “Thanks to the approval of the civil aviation authority for Berlin–Brandenburg, we can now fit other major projects with SCANTER 5XXX,” says QV LUX CEO Peter-Heinrich Boysen. The system has been tested under real-life conditions at the Krampfer wind farm, with its six turbines.

A Milestone for Greater Acceptance

Thanks to the radar-based, on-demand night lighting system, turbine lights that flash all night long may soon be a thing of the past in entire regions. The approved area in northern Brandenburg alone spans a radius of 12 km from the radar site – and is currently being extended to 18 km. This means that more than 100 wind turbines in the region could be connected to the system. “This is a milestone toward greater acceptance for wind energy,” adds Boysen.

How It Works

The BNK system identifies flying objects within the detection area (24 km) up to an altitude of 3,000 meters, noting flight direction and speed. If a detected flying object penetrates the effective range (18 km), a light can be turned on via the Internet for nighttime marking of all connected wind farms. If the flying object leaves the switch-on area (7 km), the signal lights turn off.

The QV LUX radar system offers automated signal tracking of flying objects, Web-based information transfer, and the incorporation of new and existing wind turbines (individually or in groups). Starting July 1, 2020, on-demand night lighting will be mandatory for air traffic obstacles subject to marking requirements (Sect. 9 [8] EEG 2017 [new version]).



QV LUX GmbH

Address **Steindamm 21
16928 Groß Pankow**
Phone **+49 (0)30 351 28 86 49**
Fax **+49 (0)30 351 28 86 33**
E-Mail **phboysen@qvlux.com**
Category **Suppliers of electrical and
electronic components**
Profile **Aviation obstruction markers
& lighting systems**

Rittal GmbH & Co. KG

Greater efficiency through digital transformation

Rittal offers effective solutions across the entire wind power value chain – from engineering, to production, to smart maintenance for control panels and switchgear. For over 20 years, Rittal has supplied quality products to the world's leading systems integrators and turbine manufacturers in the wind energy industry.

Rittal GmbH & Co. KG, headquartered in Herborn, Germany, is a leading global provider of solutions for industrial enclosures, power distribution, climate control and IT infrastructure – as well as software and services.

Systems made by Rittal are deployed across a variety of industrial and IT applications, including vertical sectors such as the transport industry, power generation, mechanical and plant engineering, IT and telecommunications.

In collaboration with sister company Eplan and their smart software tools, Rittal is automating processes in switchgear engineering, manufacture, and integration that were previously manual. The result is greater efficiency in terms of both capital and operating expenditure (CapEx and OpEx) for wind turbines.

Rittal products deliver the strength, vibration resistance and corrosion protection vital to turbine dependability.

Highly robust AX compact enclosures help ensure the pitch system located in the **rotor hub** operates reliably. To shield frequency inverters and control and safety components in the turbine's **nacelle** or **tower**, Rittal offers modular solutions based on its new VX25 large enclosure system.



The enterprise's Blue e+ range, the world's most efficient cooling units, provides the ideal form of climate control for enclosures. Furthermore, the IoT capabilities of these systems lay the foundations for more intelligent, more targeted maintenance.

Rittal's modular Ri4Power system supports the configuration of low-voltage switchgear in compliance with relevant standards. In addition, options for energy storage systems range from individual enclosures to complete containerised solutions.

Rittal also offers modular edge data centres, featuring low latency and maximum security for processing data.

- 01 | The VX25 provides maximum flexibility and physical protection. Its digital twin comprises all relevant data, enabling efficiency gains across the entire value chain.
- 02 | Due to their high quality standards, solutions from Rittal can be employed in every on-shore and off-shore application.



Rittal GmbH & Co. KG

Address	Auf dem Stützelberg 35745 Herborn
Phone	+49 (0)2772 505-2219
E-Mail	hain.f@rittal.de
Web	www.rittal.com
Category	Suppliers of electrical and electronic components
Profile	Controls, cables & switchgear cabinets
Turnover	€ 2.6 billion (2018, Friedhelm Loh Group)
Employees	9,300 worldwide (Rittal); 12,000 (Friedhelm Loh Group)
Founding year	1961

Röchling Industrial

Increased efficiency with plastic!

For the development of wind turbines, Röchling Industrial offers a broad range of composites and thermoplastics used onshore and offshore by renowned manufacturers worldwide.

01

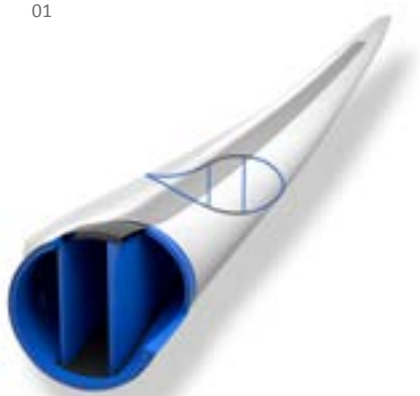

01 | Pultruded Spar Caps from Röchling, made of carbon- and glass-fiber reinforced Durostone®, giving stability and safety to rotor blades of wind turbines

02 | Slidepads of with OEMs joint developed, tribological optimized materials are adjusting the nacelle fast and precisely within the yaw system

With strong wind, blade tip speeds of up to 300 km/h and strong UV radiation, wind turbines are permanently exposed to high loads. Designers are faced with the question of how a turbine can be efficient, reliable and safe to operate even under heavy loads. The potential of wind energy is enormous, but only turbines in operation make money. High efficiencies and reduced downtimes are required.

Röchling Industrial offers a comprehensive range of composites and thermoplastics. The high-performance materials help to **develop efficient and reliable systems**. Röchling products are used worldwide by well-known manufacturers in the rotor blade, tower and nacelle, and as electrical insulation parts. The goal is always to provide the designer with the ideal material for the task at hand.

For example, pultruded **spar caps** made of carbon fibre-reinforced or glass fibre-reinforced Durostone® ensure high-performance rotor blades thanks to their strength and structure. **Sliding sheets** made of tribologically optimised materials developed jointly with OEMs ensure a fast, precise alignment of the nacelle in the azimuth system. Durostone® **trailing edge serrations** support noise optimisation and efficiency thanks to their high mechanical strength and UV resistance. The range also includes machined components for drive wheels, connecting elements, cable mounts and labyrinth seals.

Get advice now! The specialists from Röchling also provide advice during development. With 42 locations worldwide, Röchling Industrial offers a comprehensive range of materials and manufacturing know-how close to customers everywhere.

Röchling

**Röchling Engineering Plastics
SE & Co. KG**

Address **Röchlingstr. 1
49733 Haren**

Phone **+49 (0)5934 701-0**

Fax **+49 (0)5934 701-299**

E-Mail **info@roechling-plastics.com**

Web **www.roechling-industrial.com**

Category **Suppliers of mechanical
components**

Profile **Synthetic Components**

Turnover **€ 789 million**

Employees **3,687**

Founding year **1916**

02

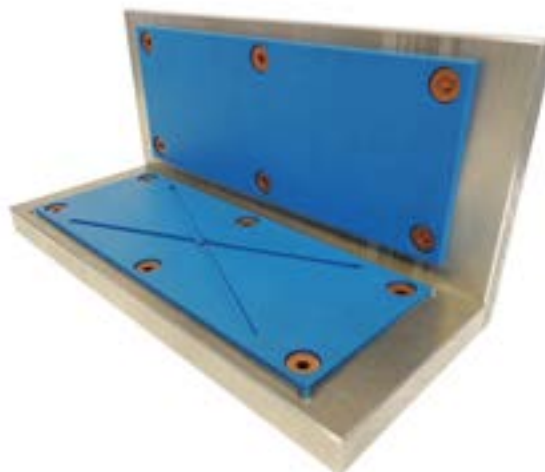

Schraubenwerk Zerbst GmbH

Fasteners for wind turbines

We fasten your wind turbine components safely and reliably. Wind turbine and component manufacturers around the world rely on Zerbst screws and fasteners.

The Zerbst plant has been manufacturing high-quality screws and fasteners for 100 years.

Schraubenwerk Zerbst has been supplying screws made of high-quality steel to the automotive industry as early as the 1920s. At that time, 30 % of overall production was exported to the US, UK, India and the Netherlands.

Nowadays the plant in Zerbst is a highly sophisticated production plant for fasteners. In addition to an extensive product range for rail track technology, Zerbst supplies industrial screws and screw fasteners to many industries. Customers around the world from the crane industry, automotive engineering, mechanical and plant engineering, and chemical plant construction trust the Zerbst brand.

Sustainable production and sustainable business management are among the corporate principles of Schraubenwerk Zerbst GmbH. Products in the field of renewable energy and wind turbines are ideally suited to this philosophy and are a dynamically growing business segment for the company.

Tower construction: HV sets up to M72, ready for installation with preset friction coefficient.

Offshore: Screw fasteners joining wind turbines to sea bed.



Rotor blade: Combination of cross bolts and specially designed thermo bolts, from smaller rotor blades to over 80m long rotor blades for offshore wind turbines.

Nacelle and components: Standard screws, specially designed screws and bolts in strength categories 8.8, 10.9 and 12.9.

Services and logistics: From the warehouse to punctual delivery to building sites around the world.

Coatings: Galvanised and lamellar zinc coated fasteners can be supplied as standard. In addition, customers can order whatever type of coating they require.

**SCHRAUBENWERK
ZERBST GMBH** 

Schraubenwerk Zerbst GmbH

Address **Altbuchsland 22
39261 Zerbst**
Phone **+49 (0)3923 713-0**
Fax **+49 (0)3923 713-200**
E-Mail **info@schraubenwerk.com**
Web **www.schraubenwerk.de/
index_en.html**
Category **Suppliers of mechanical
components**
Profile **Bolts & fasteners**
Turnover **€ 50 million**
Employees **240**
Founding year **1919**

Schaeffler

Reliability made by Schaeffler – from smart component to cloud

Schaeffler is one of the world's leading bearing manufacturers. As a development partner to the wind power sector for over 30 years, we have been producing solutions ranging from individual bearings through to complete Industry 4.0 packages that increase reliability and further reduce the LCOE.

The ideal solution for every wind turbine

Cost-effective wind turbines require reliable components. Our comprehensive understanding of systems means we can offer the ideal solution for every wind turbine – from rolling bearings with an extremely long operating life and intelligent, ready-to-fit systems with integrated sensor technology through to digital services that optimize turbine operation.

Our product range is rounded out by special rolling bearing greases and a wide spectrum of services and products for maintenance and condition monitoring. With predictive maintenance, we are expanding conventional condition monitoring approaches by allowing users to look into the “turbine's future” and thus opening up new possibilities for increasing efficiency and reducing the levelized cost of electricity.

Schaeffler Wind Power Standard

With this Schaeffler standard for products and processes, we ensure outstanding quality and reliability worldwide and can also provide the wind power sector with the levels of quality that we have already successfully established in the automotive and aerospace industries.

Optimum design with state-of-the-art calculation and simulation programs

Our specialists work closely with the developers, manufacturers, and the operators of wind turbines. State-of-the-art calculation and simulation programs ensure that optimum designs for bearings for wind power applications are produced. The entire system is considered, from individual rolling bearings and their components and adjacent construction through to the entire power transmission system, which is displayed and optimized using multi-body simulation programs developed in-house.

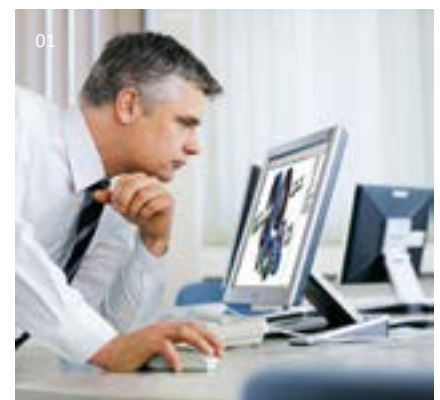



Realistic tests on Schaeffler's "Astraios"

With its realistic load simulation, Schaeffler's proprietary large-size bearing test rig ASTRAIOS has been providing valuable results since 2011, which are used for the new development of bearing solutions and for the optimization of simulation and calculation models. Based on this unique long-term experience in testing rotor bearing supports for multi-megawatt wind turbines, we have now developed a robustness test, which represents the occurrences, loads, and stresses from 20 to 25 years of wind turbine operation in just a few months, while illustrating the specific dynamics of rotor bearing support loads at the same time. This means we are making a major contribution to shortening development times for wind turbines as well as making the design process more reliable and increasing the cost-effectiveness and safety of these turbines.

Industry 4.0 can increase the availability of wind turbines and improve the system as a whole

Real operating data offer immense potential for improving drive trains' rolling bearing supports and the system as a whole, as well as for optimizing wind turbine operation. In collaboration with our customers, we are also developing sensor concepts for recording variables that influence bearing damage and have previously not been monitored.

We can interpret these data using our expert knowledge and offer our customers added value. Safety factors can be defined more accurately and adapted for new developments, for example. Digital services such as the "LifetimeAnalyzer" allow the remaining useful life of bearings to be predicted based on actual loads. In this way, we can ensure reliable operation and allow maintenance to be planned.

With Schaeffler's Smart EcoSystem, we also have a flexible and open IT infrastructure, which enables cloud-to-cloud communication. In this way, customers can also integrate our expert knowledge and digital services into their higher-level systems.

- 01 | State-of-the-art calculation and simulation programs ensure the optimum design of bearings in wind power applications.
- 02 | More safety and cost-effectiveness for wind turbines. Astraios – one of the most modern, largest and most powerful test rigs for large-size bearings in the world.
- 03 | We are continuously developing our products. Our asymmetric spherical roller bearing is a proven solution that is adapted to meet the requirements in the wind power industry even better to further extend the operating life of rotor bearing supports
- 04 | We develop sensors that allow relevant damage mechanisms for bearings to be recorded. The LoadSense Pin monitors the preload of the screw connections in flange bearing units during operation, which allows the screws to be tightened when required.
- 05 | We offer digital services, which allow the bearings' remaining useful life to be predicted, for example. Thanks to our Smart EcoSystem digital infrastructure, customers can integrate our expertise into their systems using cloud-to-cloud communication.



SCHAEFFLER

Schaeffler Technologies AG & Co. KG

Address	Georg-Schäfer-Str. 30 97421 Schweinfurt
Phone	+49 (0)9721 91-0
Fax	+49 (0)9721 91-3435
E-Mail	info@schaeffler.com
Web	www.schaeffler.de/windpower
Category	Suppliers of mechanical components
Profile	Bearings
Turnover	€ 14.2 billion (2018)
Employees	92,500
Founding year	1883

Siemens AG

Creating the most from wind

With wind equipment by Siemens, you can rely on products and systems designed for maximum performance and tried-and-tested under harshest operating conditions a thousand times. All components support seamless communication among each other throughout all

Digital Enterprise @ Wind

Our integrated holistic digital solutions along the entire wind turbine value chain are attuned to our customers' requirements. Thanks to virtual commissioning with SimCenter and PLCSIM Advanced,

our customers benefit from a very high level of efficiency in engineering and a shorter time-to-market as well as reduced workloads and less uncertainty. Digitalization also opens up brand new perspectives arising from the interaction between SIPLUS CMS and MindSphere.

This powerful Cloud platform enables the simple, efficient storage and analysis of large volumes of data. Cyber security standards in data encryption and secure access management worldwide are a matter of course to us.





01

01 | Wind Equipment Portfolio-Overview

Optimizing availability

The basis of your success is the best possible availability of wind power stations. That is why we are offering you products and systems that have already proved their worth a thousand times over. Continuous communication across all levels gives you full control over the system, from remote monitoring of each individual turbine in the control center to condition monitoring for each individual system.

Preventive maintenance minimizes downtime for repairs and allows the targeted planning of maintenance work. Furthermore, integrated protection systems prevent overloads – in extreme weather conditions for example – and safeguard your investment.

SIEMENS
Ingenuity for life

Siemens AG

Address **Gleiwitzer Str. 555
90475 Nuremberg**

E-Mail **wind-equipment.industry@
siemens.com**

Web **www.siemens.com/wind-
equipment**

Category **Suppliers of electrical and
electronic components**

Profile **Safety features & equipment**

Employees **351,000**

Founding year **1847**



02 | SINAMICS W180 – the wind converter for top performance

Maximizing efficiency

Our standardized components and coordinated systems can be combined to maximum effect to meet your specifications to a T. We ensure efficient interaction among our components in advance by means of comprehensive system tests on the hardware and software, thus paving the way for an optimal energy yield.

Minimizing the cost of energy

In competition on the wind energy market, one thing counts above anything else: having the lowest generation costs - Cost of Energy (CoE). And this, in turn, requires highly efficient wind turbines that run smoothly and without disruption. Wind turbines with high-performance, reliable components, seamlessly integrated and with optimum availability. Digitalization provides valuable support in this respect.



Reduce the time-to-market

Our smart software solutions for virtual prototyping and virtual testing help you develop new wind turbines faster and at lower cost – until they are ready for the market. Practical tools support your planning while also facilitating and speeding up your engineering. Commissioning too is faster, more reliable and less costly – thanks to coordinated components and simple handling. The digital twin along the entire value chain is the key factor here.

Security of investment over the entire life cycle

High investment security is ensured by standardized series, high connection compatibility and extensive system tests, but also by the proven industrial quality of all components. As world market leader in automation technology, our experience also enables us to ensure the highest product and production quality and verify this with the customary certificates in this industry. Should there ever be a need for replacement parts: high backward compatibility and long-term, global availability of replacement parts support rapid exchange and restart. Place your confidence in our standard products. Siemens has service centers all over the world to ensure that you are not left alone in the event of a malfunction.

SpanSet GmbH & Co. KG

Safety and quality Made by SpanSet

SpanSet supports international customers in the wind industry and offers a global service through its international network. In our own production plants we can rapidly implement individual requests.



SpanSet is an internationally operating group of companies, whose core business includes hoisting technology, cargo securing, fall protection systems and safety management. Some 820 members of staff are employed at their own production sites and sales organisations in Europe, the USA, Asia and Australia. 22 companies in 19 countries provide services to customers around the globe and generate an annual turnover of € 120 million. The German companies within the group include SpanSet GmbH & Co. KG in Übach-Palenberg, SpanSet secutex GmbH in Geilenkirchen and SpanSet Axzion GmbH in Langenfeld. The group holding company is based in Wollerau by Lake Zürich.

Round slings and hoisting belts are developed and prepared for serial production at SpanSet GmbH & Co. KG's own production facilities in close collaboration with customers, universities and research institutes. In addition, SpanSet offers numerous services, such as seminars, inspection and repairs, expert reports and certifications. SpanSet caters to the requirements of the wind power industry with bespoke products.

The Magnum-X: Extremely Robust and Compact

This heavy load round sling has a maximum load-bearing capacity of 450 tonnes. Its compact construction is one of its outstanding features. Thanks to a layer of high-performance fibre and a compact hose cladding, it is up to 50 per cent narrower and lighter than standard round slings, which reduces buckling at the load deflection point and ensures a long service life.

ClimaTech: Just in Case

This combined lap belt and safety harness has been designed for people working on wind turbines and metrological pylons. With breast and back-mounted catch points, ClimaTech can be used both as a safety and a workplace positioning harness.



01 | Magnum-X round slings for super heavy loads.
02 | ClimaTech safety harness – compliant with EN 361, EN 358 and EN 813.



SpanSet GmbH & Co. KG

Address **Juelicher Str. 49–51
52532 Uebach-Palenberg**
Phone **+49 (0)2451 4831 0**
Fax **+49 (0)2451 4831 8191**
E-Mail **info@spanset.de**
Web **www.spanset.de**
Category **Suppliers of mechanical
components**
Profile **Tools & machine tools**
Turnover **€ 26 million**
Employees **160**
Founding year **1967**

SpanSet Axzion GmbH

Intelligent lifting equipment for the wind industry

At home with wind: SpanSet Axzion specialises in lifting equipment for both on and offshore wind turbines. The company representatives of the SpanSet Group guarantee a global and comprehensive service.

SpanSet Axzion GmbH, Langenberg, is a subsidiary of SpanSet GmbH & Co. KG. The company supplies custom-made products and special solutions to the challenges involved in transporting and constructing wind turbines and other over-dimensional components, and assumes the liability risk for the complete system provided.

Quality 7 – A Single Source for All Your Needs

All product stages, from construction to service, are integrated at Axzion. The 7-point programme QUALITY SEVEN stands for the closely monitored product creation process in the in-house development and production facilities, from the raw steel to the load suspension devices. Processing high-quality materials guarantees the subsequent optimal function of the products. New developments are test-

ed at the company's own testing facilities and all finished products undergo testing by neutral testing institutes. Testing by either Germanischer Lloyd SE, Lloyds Register or Norske Veritas is mandatory requirement for offshore deployments, after which customers receive a comprehensive set of documentation. Service delivery, repairs and maintenance, and the correct use of the products are all taken care of by experienced engineers and technicians.

The Customisable SBI Spreader Beam

The SBI Spreader Beam can be transported using a standard container truck. It is quick and easy to assemble and can be adjusted to fit almost all rotor blades. Hydraulic pressure plates ensure a reliable secure connection to the rotor blade.

Vario-J-Hook XL: for Extreme Widths

The J-Hook is mounted on the flange end of the tower segment. When turning, an inner slide bearing shell rotates with the tower flange, which prevents the induction of bending forces in the flange. The externally positioned pivot point makes it possible to use J-Hook with tower flange thickness of 60 – 220 mm and heights of 200 – 400 mm.



01 | The Vario-J-Hook XL for hoisting and turning tower segments has a load-bearing capacity of up to 140 tonnes.

02 | The SBI Spreader Beam with a load-bearing capacity of 20 to 30 tonnes.



SpanSet Axzion GmbH

Address **Winkelsweg 172
40764 Langenfeld**

Phone **+49 (0)2173 208920**

E-Mail **wind@axzion.de**

Web **www.axzion.de**

Category **Operation & Service**

Profile **Service, maintenance & repair**

Turnover **€ 12 million**

Employees **90**

Founding year **1991**

STEGO Elektrotechnik GmbH

Enclosure Climatisation. Perfect.

STEGO heating elements, regulators, fans, lamps and accessories protect your sensitive electronic components against harmful climatic influences.



01 | STEGO Headquarters in Schwäbisch Hall
02 | Semiconductor Fan Heater CSL 028
03 | Electronic Hygrotherm ETF 012



STEGO products are used in all places where sensitive electronic components must be protected from humidity and other climatic influences. Heating elements, regulators, fans and STEGO accessories help you to optimise operating conditions and to reach maximum protection for your installations. So that you can be sure of lasting success!

Perfect thermal management.

Since it was founded in 1980, STEGO Elektrotechnik in Schwäbisch Hall, Germany, has been developing, producing and selling an ever-growing range of products for the protection of electric and electronic components. All STEGO products are aimed at reaching optimum climatic conditions in the most varied environments, ensuring that all sensitive components work reliably at all times.

Tried and tested temperature and humidity control systems ensure these optimised climatic conditions. If temperature and/or humidity are too low or too high, the necessary countermeasure is immediately initiated, for example a heater is turned on or a filter fan circulates cool air. A diversity of conditions such as the change from day to night, or particularly warm or cold regions, make climatisation an ever-increasing and challenging task. To meet this challenge, STEGO offers everything that is needed to protect sensitive components from corrosion and malfunction.

Worldwide service supporting quality worldwide. STEGO's thermal management solutions are exported internationally and find use in the most diverse areas of application and climatic conditions.

STEGO Elektrotechnik GmbH

Address **Kolpingstrasse 21
74523 Schwaebisch Hall**
Phone **+49 (0)791 95058 0**
Fax **+49 (0)791 95058 45**
E-Mail **info@stego.de**
Web **www.stego.de**
Category **Suppliers of electrical and
electronic components**
Profile **Cooling & climatisation**
Founding year **1980**



TECHNO-PARTS GmbH

Innovative sealing systems and moulded parts for modern technology.

In sealing technology, the smallest details are critical for reliable functioning. Our products have been doing their job reliably for years, from the tried-and-tested to the innovative component.



Over 50 years of experience in the sealing field for hydraulics, pneumatics, chemicals and plant engineering have made us a high-performance company. We cover almost all applications – from miniature pneumatics to heavy-duty hydraulics, from chemicals and plant construction to offshore wind turbines. We continuously put our experience to work in the development and optimisation of our growing product range.

Our staff's wide-ranging expertise ensures a comprehensive service – from technical advice to our customers on-site to flexible order handling and on-time delivery.

A warehouse with well over 20,000 different items and flexible production for machined and injection-moulded products, combined with in-house tool-making, enable us to meet most customer requests in the shortest possible time.

A well-equipped laboratory for physical and chemical testing, comprehensive experiments and certification in accordance with DIN EN ISO 9001 make a significant contribution to our high quality standards and the further development of our products.

Individual packaging is just as much a part of our services as our own eKanban system and a quick service for urgent repairs and prototypes.

For the special requirements of wind turbines, we also supply radial shaft seals with high-strength, fabric-reinforced elastomer backs and excellent sliding properties. The shaft seals are available for internal and external sealing, also in split design with diameters up to 4,000 mm. This facilitates repairs and alleviates difficult installation conditions.

- 01 | Shaft seals for wind turbines and for heavy machine construction
- 02 | Most modern storage technology and more than 20,000 different articles in stock
- 03 | Headquarter in Essen



TECHNO-PARTS GmbH Sealing and Plastics Technology

Address **Alte Bottroper Strasse 81
45356 Essen**
Phone **+49 (0)201 86606-0**
Fax **+49 (0)201 86606-68**
E-Mail **vk@techno-parts.de**
Web **www.techno-parts.de**
Category **Suppliers of mechanical components**
Profile **Seals & vibration control**
Founding year **1981**

TOTAL Deutschland GmbH

Better Energy with TOTAL's Wind Concept Plus

The cost of electricity in KW/h, which has a major influence on market growth in the field of renewable energies, is cited as one of the key factors responsible for the rapid development of the energy sector. It is in this context that TOTAL created the innovative Wind Concept Plus strategy.

TOTAL is dedicated to the task of taking a holistic view of developments in the renewable energies sector and making continuous improvements, whereby Wind Concept Plus is based on three important, correlated pillars.

The first pillar represents the interplay between innovation and specialisation. TOTAL not only wants to push innovations in the form of new lubricants for customers in the industrial sector but also at the same time to exploit the potential for a

new development to the fullest extent possible. The exchange of information and collaboration with long-term and new customers is essential for this strategy.

This is closely linked to the second pillar in TOTAL's strategy, which entails focusing on customer satisfaction. TOTAL provides high-quality lubricants and places just as much value on excellent service. In collaboration with our customers, listening to and including them as well as the subsequent further development of the lubricants are prerequisites for meeting and exceeding the demands placed on the TOTAL lubricants. TOTAL customers benefit from a professional consultancy service provided by competent application engineers and value-added services including, among others, the rationalisation and organisation of lubrication tasks, maintenance, laboratory analyses of your operational substances as well as lubricant training for your staff.

As the third pillar, TOTAL provides bespoke long-life lubricant solutions to support renewable energies. CARTER WT 320, for example, high-performance transmission oil extends change intervals by up to 10 years. This impressive PAO-based product provides excellent protection for the cogs against micro-pitting. Its high viscosity index results in improved performance at extremely low temperatures and is specifically designed to reduce wind turbine down time.



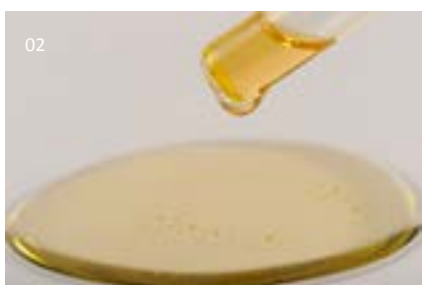

TOTAL ANAC

TOTAL ANAC provides the entire range of oil analyses for all activities and applications. The energy concern TOTAL has over 35 years' experience in oil analysis and maintains a database of more than four million analyses. This volume of stored data records also includes around 15,000 types of mechanical components and motors and, in addition, ensures the monitoring of some 500,000 components. The ANAC oil analysis is suitable for drive assemblies, hydraulics and industrial applications. Based on the scientific interpretation of the results of the used oil analysis, various conclusions can be drawn about actual wear and tear conditions and machine maintenance operations can be optimised accordingly, which in turn results in a reduction in maintenance costs (per kilometre or hour). We recommend using TOTAL ANAC for the systematic monitoring of wear and tear in drive assemblies, the prevention of damage and to extend the operational life of drive assemblies as well as for condition oriented preventive maintenance.

ANAC Wind

The trouble-free operation of a wind turbine is strongly dependent on the performance of the reduction gear unit, which requires special monitoring due to the harsh operating conditions. Oil analysis is an effective measure for ensuring that these important components remain properly lubricated, reducing maintenance costs and ensuring the reliability of wind turbines.

TOTAL's ANAC Wind package is an oil analysis service, particularly for use in the renewable energies sector, which gives customers access to the expertise and experience of our product developers. TOTAL can draw upon an extensive wealth of experience in relation to analyses and transmission oils. ANAC's core component is a database of all properties specific to TOTAL lubricants.

During the oil analysis, a specialised wind turbine engineer assesses the operating conditions of the machine. The optimal lubricant is then selected based on the engineer's assessment, the use of other condition-based maintenance procedures (vibration analyses, thermography etc.) and the results of the ANAC oil analysis. The oil analysis facilitates a reduction in maintenance costs as well as the optimisation of the oil change intervals. In addition, the wind turbine maintenance operations can be better planned on the basis of the analysis results, which leads to a reduction in turbine down time.

Direct Energy – TOTAL as a wind turbine operator

In addition, TOTAL has been operating wind turbines for many years, which has facilitated the continuous further development of the lubricants. In July 2018, the energy group acquired a 75 per cent share of Direct Energy, a French electricity supplier, and therefore a significant expansion of the power generation capacities in France and Belgium. Founded in 2003, the company is France's third biggest electricity supplier, which makes it an important market player in the photovoltaic and renewable energies sector.

01 | Photo: Sophie Trama

02 | Photo: Véronique Paul



TOTAL Deutschland GmbH

Address	Jean-Monnet-Str. 2 10557 Berlin
Phone	+49 (0)30 202 76 787
Fax	+49 (0)30 202 77 96 634
E-Mail	rm.industrie@total.de
Web	www.total.de/industrie
Category	Suppliers of mechanical components
Profile	Lubricants & lubrication systems
Turnover	€ 15 billion
Employees	3,000
Founding year	1955

thyssenkrupp rothe erde Germany GmbH

thyssenkrupp rothe erde – Products for Perfect Rotation.

With production sites in ten countries, thyssenkrupp rothe erde has been an impressive reliable partner to all wind turbine manufacturers for decades. We develop bespoke solutions for equipping all bearing points and surfaces in wind turbines, which are deployed around the globe.



make thyssenkrupp rothe erde's testing centre unique in the world, which enables us to optimise the development of our products to meet individual customer requirements.

Rotor Bearings

Whether single or multi-row construction type, clamped or bolted installation, insert or non-slip inductively hardened bearing race – we can develop and manufacture the appropriate solutions with diameters of up to 6500 mm.

Blade and Yaw Bearings

We recommend single and double-row four-point bearings as well as triple-row roller bearings for this purpose. We manufacture blade and yaw bearings with diameters of up to 8000 mm.

With the perfect combination of experienced staff, international production sites and our modern research and development centre, we partner with our customers to overcome the challenges of on and offshore power generation.



thyssenkrupp

This is Where the Future is Tested

The most up-to-date testing methods and efficient analysis tools facilitate an optimised layout. To test our products in conditions as close to the real world as possible, thereby ensuring the highest level of quality, we rely on testing based on real connection structures on a 1:1 scale.

In addition to existing rotor bearing and blade bearing testing facilities, a new blade bearing test bench has significantly increased our testing capacities. We can test next-generation-turbine blade bearing at this test facility using real hub and rotor connection structures, with a focus on multi-MW offshore applications with turbine power generation capacities of up to 15 MW. This enables us to evaluate and continuously improve the quality of our products and processes under real-world conditions. These extensive possibilities



thyssenkrupp rothe erde
Germany GmbH

Address **Tremoniastr. 5-11
44137 Dortmund**
Phone **+49 (0)231 186-0**
Fax **+49 (0)231 186-2500**
E-Mail **rotheerde@thyssenkrupp.com**
Web **www.thyssenkrupp-rotheerde.com**
Category **Suppliers of mechanical components**
Profile **Bearings**
Employees **7,500**
Founding year **1861**

Weidmüller GmbH & Co. KG

Your partner in Industrial Connectivity

Operating wind turbines efficiently – optimum yield with our automation solutions

Operating wind turbines efficiently – optimum yield with our automation solutions

Nowadays, the wind energy sector is faced with the challenge of meeting growing profitability requirements. This means that plant performance requirements are becoming ever greater. Therefore, more straightforward servicing, short assembly times and the reduction of downtimes are increasingly important.

The employment of efficient technologies in wind turbine control or communication has a considerable role to play in this context. This also applies to the employment of modern development tools. The engineering process is becoming increasingly efficient as hardware and software design become standardised and therefore closely integrated. A further trend is condition monitoring – alongside consumption and energy balancing, damage such as cracks can be recognised in good time.

We've confronted the challenges of the market as long standing partners in the energy sector. We offer customised automation solutions – alternatively as complete package or individual components for the wind energy of the future. We call the concept of efficient and flawless plant operation "Never stop!".

Automation solution for small wind turbines:

hardware, software, engineering for the tower and nacelle, as well as services such as plant project planning and services.

Rotor blade monitoring:

BLADEcontrol® measures changes to the natural vibration behaviour of the rotor blade and detects besides ice accretion also damages and operation deviation of your rotor blades.

Customised housing assembly:

functional modules, which we create on the basis of our many years of experience in the sector and assemble with suitable components from the Weidmüller catalogue.



01 | Operating wind turbines efficiently – Optimum results with our automation solutions

02 | Cabinet Installation

Weidmüller 

Weidmüller GmbH & Co. KG

Address	Klingenbergstrasse 16 32758 Detmold
Phone	+49 (0)5231 1428-0
Fax	49 (0)5231 1428-116
E-Mail	weidmueller@weidmueller.de
Web	www.weidmueller.com
Category	Suppliers of electrical and electronic components
Profile	Controls, cables & switchgear cabinets
Turnover	€ 700 million
Employees	4,700
Founding year	1850

Weitkowitz GmbH

Always a safe connection. Guaranteed!

Weitkowitz has been manufacturing and supplying cable terminals, connectors, ferrules, cable ties, mechanical and hydraulic pressing and cutting tools for over 100 years. We'd be glad to collaborate with you to develop special wind energy solutions.



Clients from the fields of electrical installation, switchgear and transformer construction, cable assembly, lightning protection, railway engineering, wind energy and photovoltaics have been successfully using Weitkowitz products in their products and systems for many years.

Weitkowitz GmbH has stood for quality products in the electrical sector for decades. Our WM press-fit geometry", which was originally developed by Franz Weitkowitz, personifies our claim to quality, functionality and the longevity of all our products and services, which is as valid today as it always has been.

Special solutions, such as our rectangular cable terminals and connectors, offer protection from such things as the chamfering of surge arresters. Press-fit and screw connectors allow for the quick and easy installation of cable harnesses when setting up wind-energy turbines.

Talk to us and let us know your requirements: we'll be happy to work with you to find the perfect solution for your specific needs.

Our slogan "A secure connection guaranteed!" is a promise that reputable clients from all over the world rely on every day. Of course, our company is also ISO9001 and ISO ITS16949 certified and, therefore, meets the highest quality requirements for various sectors including the automotive industry.

- 01 | Equipment for wind turbine
- 02 | Company headquarter
- 03 | The APW18 battery accumulator
- 04 | Rectangular cable terminal and connector



Weitkowitz GmbH

Adress **Wolterfer Strasse 125
31224 Peine**
Phone **+49 (0)5171 70610**
E-Mail **info@weitkowitz.de**
Web **www.weitkowitz.de**
Category **Suppliers of electrical and
electronic components**
Profile **Energy & data transmission**
Turnover **€ 24 million**
Employees **170**
Founding year **1918**



Winergy

Flender GmbH

With over 150 GW gearbox capacity supplied Winergy is the leading component manufacturer for wind turbines. Winergy offers gearboxes in a power range of 750 kW – 10 MW and more, as well as service.

Reliability is the foundation of a long-term partnership

In 1981, Winergy started to manufacture gearboxes specifically designed for wind turbines. Today, with nearly 40 years of experience, Winergy offers the complete mechanical part for the drive train. To date Winergy has supplied more than 150 GW of gearbox capacity. Reliable, efficient and at low lifecycle costs Winergy gearboxes and couplings ensure that wind turbines all over the world convert windpower into electrical energy.

To support your customers globally – you must be represented locally

Since Winergy's foundation, we have successfully implemented a globalization strategy and today operate production facilities in Europe, USA, China and India. Apart from that Winergy is continuously expanding their service locations for example in Australia, Japan and Brazil.

- 01 | Winergy gear
- 02 | Production processes according to VDA-6.3. quality standards
- 03 | Broad service portfolio including uptower services



Quality is more than just a word to us – it is the essence of our products

The quality that we demand from our products is also reflected in our processes. Our customers all around the world benefit from our high-quality products and short delivery times. This is achieved with our comprehensive and fully integrated process management, lean operation and zero defect tolerance.

Our drive train components are as unique as your requirements

Detailed wind turbine specification is the foundation of individual drive train development. Winergy takes its long-term experience into account to develop cost-effective solutions that perfectly fulfill customer requirements. The result: mechanical components which increase energy efficiency.

Reliable service solutions

We have service concepts that are individually tailored to the requirements of our customers. The objective is to ensure high availability of your systems, resulting in reduced operating costs.



Winergy

Address	Am Industriepark 2 46562 Voerde
Phone	+49 (0)2871 92-4
Fax	+49 (0)2871 92-2487
E-Mail	info@winergy-group.com
Web	www.winergy-group.com
Category	Suppliers of mechanical components
Profile	Gears
Turnover	€ 700 million
Employees	4,700
Founding year	1981

COMPANIES:

Service & logistics

Planning, finance, transport, construction and marketing. The fields of planning and operation of wind turbines are a continuous growth market in Germany.



Photo: Jörg Böhling



ABICON GmbH

Independent – Innovative – Competent

As an innovative project developer, we plan and implement sustainable energy concepts in the area of renewable energies: with our corporate network we are prepared to meet any and all challenges.



01

Founded by the current Managing Partners Dr. Andreas Möller and Thomas Knieling in 2007, ABICON GmbH provides expert support throughout every project development phase from site acquisition to commissioning for operational service as well as commercial and technical operational management with a focus on wind energy, photovoltaics and biogas.

Our project development operations are based on four principles:

- The inclusion of all project stakeholders and open communications
- Rapid project implementation and bespoke solutions
- Absolute transparency throughout the project development phase
- Contact person throughout the project and beyond

With the implementation of the world’s most sophisticated environmental management system, EMAS, we undertake to ensure the continuous improvement of our operational environmental services beyond what is prescribed by the relevant legislation. ABICON GmbH’s primary objective is to develop economically sustainable concepts that increase regional added value, whereby our team views itself a facilitator, whose role is to liaise with the authorities, land owners, energy suppliers, communities, the public and investors. In this spirit, we see environmental conservation and renewable energies as going hand-in-hand rather than being diametrically opposed.

ABICON GmbH and its shareholder GP JOULE have been collaborating in a strategic partnership since 2015 with the aim of achieving the best possible implementation of existing projects and dealing with future challenges. A steadily growing team of agricultural engineers, geographers and environmental specialists are working together to achieve the ABICON vision – the continuous expansion of renewable energies for a clean environment.



ABICON GmbH

Address **Schönsteiner Strasse 23
34630 Gilserberg-Moischeid**
 Phone **+49 (0)6696 912 939 10**
 Fax **+49 (0)6696 912 939 20**
 E-Mail **info@abicon-gmbh.de**
 Web **www.abicon-gmbh.de**
 Profile **Planners & project developers**
 Employees **17**
 Founding year **2007**

- 01 | Two wind turbines at the Hassenhausen wind farm
- 02 | Dr. Andreas Möller, Managing Director of ABICON GmbH
- 03 | ABICON during a site visit to a wind farm



02



03

ABO Wind AG

Full Service Provider for Wind Farm Development, Construction & Maintenance

ABO Wind is one of Germany's renowned wind energy specialists, offering the full range of wind farm development, financing, construction and grid connection. The company also provides operational management, services and technical solutions for an optimised output.

23 Years of Wind Energy Expertise

As a project developer, ABO Wind has been contributing to the global clean energy transition since 1996. So far, ABO Wind has developed, constructed and commissioned more than 1,500 megawatts of wind energy capacity in six countries and sold a further 600 megawatts ready for construction. 550 employees realise projects with an investment sum of about 300 million euros per year. In addition, ABO Wind provides technical and commercial operational management and maintenance services for a total capacity of 1,700 megawatts across Europe. ABO Wind also develops photovoltaic projects and hybrid solutions that combine wind energy, photovoltaic systems and energy storage.

Project Development and Repowering

ABO Wind initiates wind energy projects, acquires land or existing projects, carries out all technical and commercial planning and engineering, prepares bank financing and builds the plants on a turnkey basis. Among municipalities, landowners and energy cooperatives, ABO Wind is known as a fair and reliable partner.



02

Operational Management and Technical Solutions

Remote monitoring, on-site service, contract management, and accounting: Our flexible modules offer the perfect fit for each wind farm. In addition, experienced engineers develop smart solutions such as the access control ABO Lock", which allows operators to control and log access to their wind farms conveniently and without a keyless entry.

Service, Maintenance & Technical Assessment

ABO Wind offers maintenance, repair, safety checks, inspections and troubleshooting from a single source. Our technical experts assess all major plant components, from the foundation and tower to the drive train and rotor blade.

- 01 | Installation of rotor blades during the re-powering process of Framersheim wind farm (Rhineland-Palatinate)
- 02 | Staff in control room monitors operations of wind farms
- 03 | ABO Wind's own service teams take care of inspections, safety checks, fault clearance and repairs



03



01

ABO WIND

ABO Wind AG

Address	Unter den Eichen 7 65195 Wiesbaden
Phone	+49 (0)611 267 65-0
Fax	+49 (0)611 267 65-599
E-Mail	kontakt@abo-wind.de
Web	www.abo-wind.de
Category	Planning
Profile	Planners & project developers
Turnover	€ 300 million (project volume)
Employees	550
Founding year	1996

Aero Enterprise GmbH

Aero Enterprise stands for quality, traceability and efficiency.

Aero Enterprise offers a full-service package for the airborne inspection of on- and offshore wind turbines by the use of the self-developed hardware AERO-SensorCopter and the AERO-Software Package.

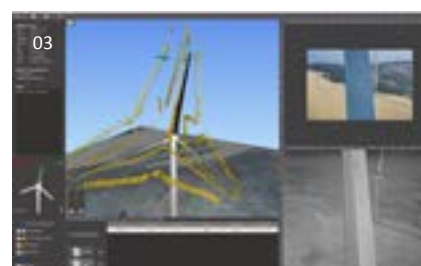

As part of a new and sustainable inspection service, Aero Enterprise is using **aerial robots to inspect onshore and offshore wind turbines** as well as industrial facilities, dams and bridges. All high-resolution image data of the inspected objects are recorded by the use of the self-developed flight robot *AERO-SensorCopter*, which is specially designed to perform under harsh offshore weather and wind conditions.

The AERO-Software Package offers the opportunity to **analyse, qualify, classify** all acquired data as well as to generate reports. Respective anomalies can be recognized in their exact geo-location and position. The anomalies can be quantified in area and length and classified according to standardized classes and types.

The result is an automated generated, complete and transparent IT-based **report**. This generated status report reflects the inspected object comprehensively. In order to meet the specific needs of our customers the inspection results can be automatically generated as a PDF report, but also can be transferred via interfaces as customer-specific files formats directly into the customer's ERP systems.

A new developed feature is the usage of artificial intelligence (AI) which qualitatively and significantly raises the **automatic detection** of anomalies. For this purpose, the program is continuously fed with already recorded data of anomalies. Based on this input data, the program independently recognizes similar errors by use of different algorithms (machine learning). This, speeds up the manual analysis process many times over.

Why choose Aero Enterprise?

- Standardized and digitized data quality
- Strong wind stability of the AERO-SensorCopter
- Efficient damage assessment
- Cost reduction
- Health & safety protection
- Predictive maintenance



Aero Enterprise GmbH

Adress **Industriezeile 35
4020 Linz, Austria**
 Phone **+43 (0)7435 21110 100**
 E-Mail **office@aero-enterprise.com**
 Web **www.aero-enterprise.com**
 Category **Operation & Service**
 Profile **Service, maintenance & repair**
 Employees **7**
 Founding year **2013**



01 | AERO-SensorCopter Offshore
 02 | High resolution images
 03 | AERO-Lyse as part of the AERO-Software Packages for analyzing anomalies
 04 | Aero Enterprise quality cycle

BDO ARBICON GmbH & Co. KG

Industry knowledge is a question of experience

Our industry team is your consulting partner for wind energy companies and projects in the fields of audit, tax consultancy, legal advice, corporate finance and IT.

As a medium-sized audit firm, BDO ARBICON has regional roots as well as a strong national presence and excellent international links. Our team currently comprises 100 highly qualified experts in Oldenburg, Germany. At BDO, almost 1900 employees at 27 locations throughout Germany are available as partners to help ensure the success of our clients.

We have actively accompanied and helped shape the rise of the renewable energies sector since the early 1990s. We are a founding member of a supra-regional energy cluster and belong to the relevant industry associations within the BEE e.V. We use these strong networks to bring together knowledge streams and guarantee our clients a broad range of industry knowledge.

Our areas of expertise:

- Conception and structuring of financial concepts, particularly civic energy projects
- Annual financial statements
- Audit of annual accounts in accordance with HGB, IFRS, VermAnIG, KAGB
- Preparation of sales brochures (VermAnIG, KAGB and WpPG)
- External assessors of RE projects in accordance with KAGB (recognised by BaFin)
- Due diligence checks
- Complex tax returns for affiliated companies
- Assessments
- Compilation of profitability analysis, budgeting, modeling, support with investment decisions
- Yield certificates
- Transaction consulting
- Profitability of sector coupling models

By working closely with BDO's energy management business centre, we are able to meet the challenges of both the conventional energy industry and energy-intensive industry. For technology questions, we rely on the expertise of BDO Technik- und Umweltconsulting GmbH. Thanks to its international network of nearly 80,000 employees in 162 countries, BDO always has the right contact for you.



BDO ARBICON GmbH & Co. KG

Address **Moslestrasse 3
26122 Oldenburg**
Phone **+49 (0)441 980 50 0**
Fax **+49 (0)441 980 50 180**
E-Mail **info@bdo-arbicon.de**
Web **www.bdo-arbicon.de**
Category **Finance & Law**
Profile **Tax accountants**
Founding year **1995**

01 | Experienced team of experts for windenergy
Sebastian Schwarting, Michael Siefken, Frank
Reiners, Armin van Hoorn, Klemens Lücke and
Sonja Hannover

BayWa r.e. renewable energy GmbH

r.e.think energy

BayWa r.e. is one of the leading providers within the renewable energy sector in wind power, solar, bioenergy and geothermal. Our many years of experience in the wind energy sector in conjunction with a comprehensive service range benefit customers and business partners alike.

As specialist in developing, planning, financing, building, managing, maintaining and marketing of wind turbines, BayWa r.e. is a solid and experienced partner. BayWa r.e. offers a diverse range of services:

Project development and turnkey construction

BayWa r.e. has developed and implemented wind farms with installed capacity of over 1,400 MW worldwide.

Since the introduction of EEG 2017 in the future partnership models between the parties involved will become increasingly important to ensure the ongoing success

of projects. For this reason, we have developed various partner models which support community wind farms, public utilities and smaller developers in all project phases, as and when required.

The range of services includes:

- Site analysis and evaluation
- Land acquisition
- Acquisition of project rights at each development stage
- Custom-made partner models
- Planning permission/implementation
- Turnkey construction as a general contractor
- Project structuring and funding

Technical and commercial management

As a service provider for investment funds, banks, international investment companies, municipal utilities and citizens' cooperatives, BayWa r.e. manages the technical and commercial aspects of wind and solar energy projects with total rated capacity of over 5,200 MW all over Europe. The range of services includes:

- 24/7 monitoring through the control centre with multilingual staff
- Service and maintenance for high voltage installations
- Regional service staff for checks and immediate troubleshooting
- Full responsibility for the plant and DGUV V3 electrical equipment tests
- IT security for a reliable plant communication
- Infrared (IR) inspections with drones
- Contract and stakeholder management
- Accounting
- Budget and liquidity management
- Representation of the operator's assets



01 | Wind farm Hamwiede (Germany)
 02 | Rotor blade heavy load Dachsbach (Germany)
 03 | Heavy load with own truck fleet
 04 | Wind farm Oberwohld (Germany)



02



03



04

Direct marketing and energy trading

As one of the leading direct marketing companies in Germany and an operator of a virtual power plant, BayWa r.e. Clean Energy Sourcing GmbH provides operators of wind farms and photovoltaic plants a comprehensive and transparent service, as well as access to all relevant electricity markets.

- Direct marketing of electricity generated by wind farms, as well as photovoltaic, bioenergy and geothermal plants
- Connection to our virtual power plant to ensure remote controllability
- Attractive remuneration models for plants that are not being subsidised
- WindGuide 20+ (www.wind-guide.com) for plants whose EEG subsidies are ending

Rotor blade services

As a certified and manufacturer-independent service provider, BayWa r.e. provides extensive services to optimise and maintain rotor blades of all manufacturers and performance categories:

- Servicing and maintenance of rotor blades, on site and at the factory
- Assessments, warranty inspections and periodic inspections
- Cleaning and sealing of rotor blades, as well as cleaning of nacelles and towers
- Distribution of used wind turbines
- Developing add-on components to optimise rotor blades
- Heavy-duty transportation fleet
- Disposal of rotor blades
- Replacement blade sets on stock

Planning and consulting

BayWa r.e. offers comprehensive technical consulting and planning services for renewable energy.

The range of services includes:

- Due diligence reports
- LIDAR measurements
- Yield and emission reports
- Feasibility studies
- Permission planning and management
- Implementation and monitoring construction
- Grid planning Project management
- Optimising operation

Together with experienced employees from BayWa r.e., numerous customers and business partners have been able to realise the most appropriate solution for their business success. Moreover, backed by the financial strength of BayWa AG, BayWa r.e. is a reliable business partner for the long term.



BayWa r.e. renewable energy GmbH

Address **Herzog-Heinrich-Strasse 9
80336 Munich**

Phone **+49 (0)89 383932-0**

Fax **+49 (0)89 383932-32**

E-Mail **info@baywa-re.com**

Web **www.baywa-re.com**

Category **Planning**

Profile **Planners & project developers**

Turnover **approx. € 1.5 billion (2018)**

Employees **1,800**

Founding year **2009**

BIL eG

Double benefit for the wind energy sector

Germany’s nationwide information system for pipeline inquiries, BIL, provides a centralized inquiry portal for those carrying out construction activities and for operators of wind power plants. This is highly beneficial to both sides during the construction phase and during operation. Since February 2016, some 220,000 inquiries coming from over 18,000 users have been successfully processed by the BIL portal.



By participating in the BIL process, operators of wind power plants can significantly improve the safety of their grid feed-in. Since the topographic distance between the generating plant and the feeding point is often long, it is particularly important for pipeline operators to be clearly identified by those pursuing construction activities in order to avoid pipeline damage. Especially operators that are less widely known benefit from the large number of inquiries coming from pipeline companies as it gives them a better overview of the construction activities planned in the area of their pipeline infrastructure.

In response to online user inquiries, the BIL process returns a positive and negative list. The relevant operators are automatically identified by the query process (about 67 percent).

The remaining inquiries (about 33 percent) will not reach the pipeline operators, significantly reducing the time and effort spent processing irrelevant inquiries. This marked reduction in negative responses that need to be issued makes the BIL fee well worthwhile even for small grid operators. BIL offers a special set of fees tailored to the wind power sector.

BIL is an initiative of pipeline operators in Germany organized as a cooperative and the first to provide an online inquiry portal free of charge in Germany. Its goal is to increase the safety of pipeline networks by establishing a single point of entry for inquiries. To date, more than 75 companies participate in the BIL portal.

For more information, please visit www.bil-leitungsauskunft.de



BIL eG
 Address **Josef-Wirmer-Str. 1–3
 53123 Bonn**
 Phone **+49 (0)228 92 58 52 90**
 E-Mail **info@bil-leitungsauskunft.de**
 Web **www.bil-leitungsauskunft.de**
 Category **Operation & Service**
 Profile **Service, maintenance & repair**

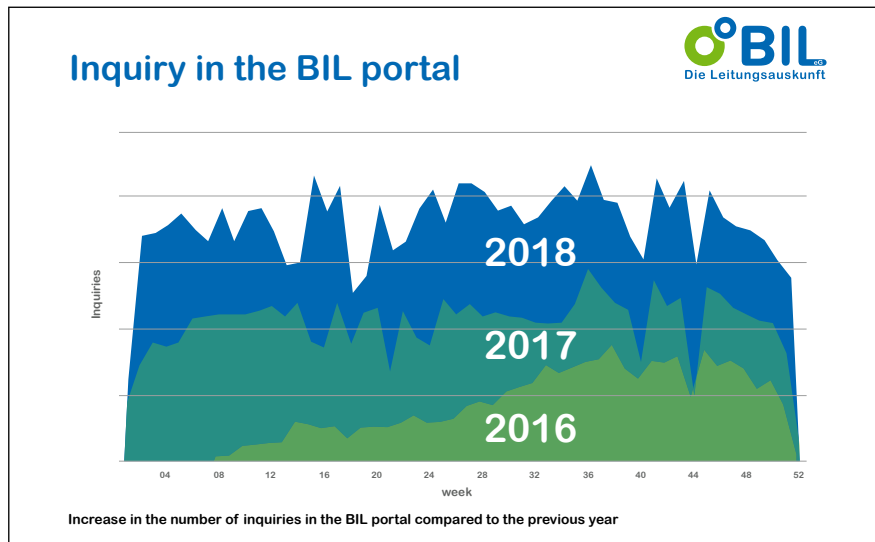

Connected Wind Services Deutschland GmbH

Service & Maintenance – Service Projects – Spare Parts – Refurbishment
Connected Wind Services is one of the leading independent service providers

We are Connected Wind Services.
An independent, global service partner in the renewable energy market. Though our name is new, our history, heritage and experience is not.

Dedicated to advancing the transition to sustainable energy, we challenge the current service solutions and explore new, innovative ways to reduce complexity and optimize the operation of wind turbines by combining our vast knowledge and experience with progressive thinking.

Always observant and understanding of individual client needs, we tailor solutions and service concepts to reduce downtime and ensure longevity, maximum yield and protection of assets and resources.



For the benefit of us all. We believe pioneering people to be the driving force behind positive change. And we aim to do our part in supporting their mission.

With a local presence and trust and transparency as our guiding principles, our clients can rely on us as the professional partner, that makes their obstacles disappear and keeps them moving forward.



Connected Wind Services Deutschland GmbH

Address **Mühlenberg 19
25873 Rantrum**
Phone **+49 (0)4848 90 128-0**
Fax **+49 (0)4848 90 128-22**
E-Mail **info.de@connectedwind.com**
Web **www.connectedwind.com**
Category **Operation & Service**
Profile **Service, maintenance & repair**
Turnover **€ 8.6 million**
Employees **60+, 180+ Group**
Founding year **1987**

CWD Aachen GmbH – Center for Wind Power Drives

We connect research and the industry

Drivetrains of wind turbines are subject to complex loads. We are driven by the need to identify these loads and take them into account in the design process before a wind turbine goes into operation. From Simulation to Testing into the Field.

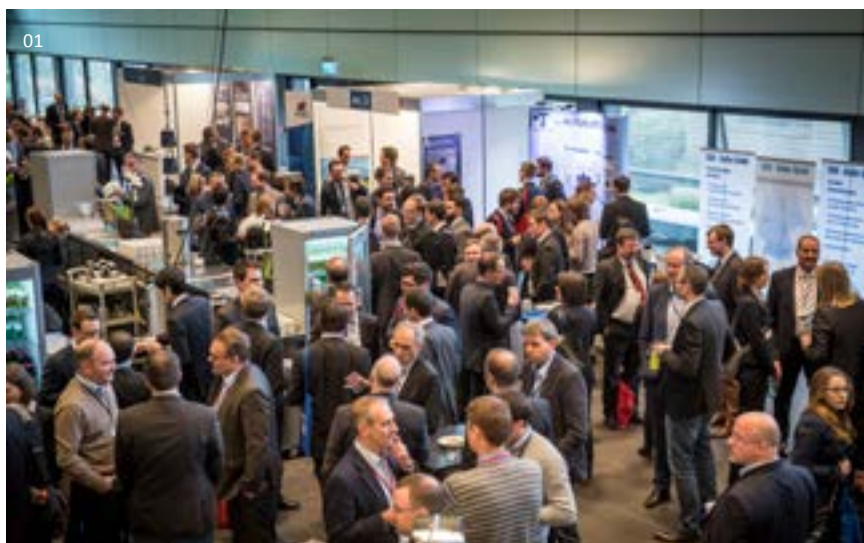

01 | Conference for Windpower Drives

02 | CWD WindLocator – an airborne wind measurement system to understand local wind phenomena



**CWD Aachen GmbH –
Center for Wind Power Drives**

Address **Mathieustrasse 30
52074 Aachen**
Phone **+49 (0)241 8095662**
Fax **+49 (0)241 8092885**
E-Mail **info@windpower-aachen.de**
Web **www.windpower-aachen.de**
Category **Other services**
Profile **Development & construction**

Increasing cost pressure determines the day-to-day business of manufacturers of wind turbines and their components. Progress in this area, for example in the form of significant increases in transmission power density, is currently being implemented. In this context, manufacturers are increasingly availing the advantages of plain bearings regarding installation space not only for gearboxes but also for rotor bearings.

Site-specific requirements lead to a rapid growth in the variety of systems with shorter development cycles at the same time. As a result, the right product structure with skillful use of variants and modules, as well as sufficiently agile product development and the use of digitization, are becoming increasingly important.

In addition to drive train developments, the improved analysis of potential turbine locations also offers a possible increase of annual energy yields.

We use semi-annual CWD workshops to discuss research ideas and initiate projects. We cordially invite you to participate in these workshops. Currently, about 20 industry partners from power utilities, OEMs, component manufacturers and service providers are involved in these workshops as members of CWD.

The second major platform for the presentation and discussion of our research and development results is the Conference for Wind Power Drives, which takes place every two years at the Eurogress in Aachen. Together with its industrial partners and other national and international market participants, the latest state of research and technology in the field of drivetrain technology of wind turbines will be presented at this conference.

Become part of this community and benefit from interdisciplinary solutions of the complex requirements in wind turbine drivetrains.



Deutsche Kreditbank AG

Connecting projects locally and on site.

With almost 2,400 financed wind turbines and one of the largest renewable energies portfolios, we are your strong partner for wind energy projects in Germany.

More than a third of gross electricity consumption is already covered by renewable energies, around half of which is produced in wind power plants. Wind therefore makes an essential contribution to the energy transition.

DKB has been a financial partner of the wind energy industry for more than 20 years. We have financed more than 2,400 installations in recent years.

Together with our customers, we develop an individual financing concept for each project. DKB customer advisors are not only financial experts, they're energy experts too. They develop financing solutions tailored to the different technologies and locations while taking funding conditions into account.

It's important for us to be close to the customer and project. That's why we have 24 locations throughout Germany. We connect players from different customer groups – plant constructors, municipal utilities, supraregional energy suppliers, municipalities and farmers. This leads to new solutions and collaborations.

This also includes the economic participation of citizens in wind and solar parks or local heating networks. In recent years, we have implemented more than 100 civic participation projects with our customers.

We understand energy transition not only as power transition, but we also support the heating and mobility transition as well as sector coupling. Under the Energy Solutions label, we offer financial solutions for projects in combined heat and power, e-mobility, contracting and energy storage.

DKB is the financier of the energy transition and your strong partner. Bayerische Landesbank, the parent company of DKB, supports international and offshore projects.



DKB
Das kann Bank

Deutsche Kreditbank AG

Address **Taubenstr. 7–9
10117 Berlin**
Phone **+49 (0)30 12030-9930**
Fax **+49 (0)30 12030-9902**
E-Mail **joerg-uwe.fischer@dkb.de**
Web **www.dkb.de/erneuerbare-energien**

Category **Finance & Law**
Profile **Banks, financial institutions & financial service providers**

Employees **about 3,520 (group)**
Founding year **1990**



01 | Customer dialogue 130 m above the earth: Jörg-Uwe Fischer, head of competence centre renewable energies at DKB and Jan Teut, Teut Windprojekte GmbH

Deutsche Messe AG

Energy industry meets at HANNOVER MESSE

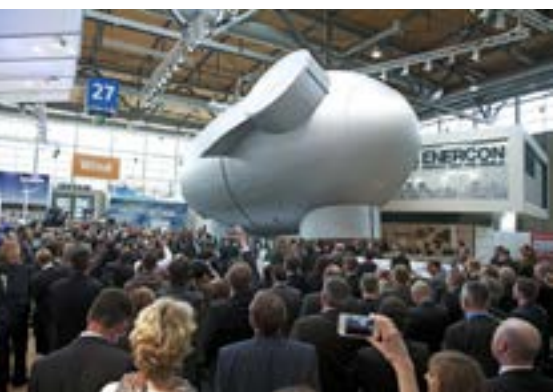

The core business of Deutsche Messe AG is the organisation of leading international trade fairs in Hanover and abroad. The international exhibition business is particularly focused on the growth markets in China, Southeast Asia, Australia, Turkey and North America. The main theme at these key fairs is on capital goods.

Deutsche Messe is organising the world's most important event for the industry at the HANNOVER MESSE. The exhibition area Energy Solutions with more than 1,000 exhibitors is an important part of HANNOVER MESSE. Every April, the energy industry meets there to find out about new technical solutions for the energy system of the future. Integrated energy is a key area. In addition to the integration, control and intelligent networking of decentrally generated energy from renewable energy sources such as wind or PV plants, Hannover Messe also looks at storage, energy management and the energy infrastructure needed for electromobility.

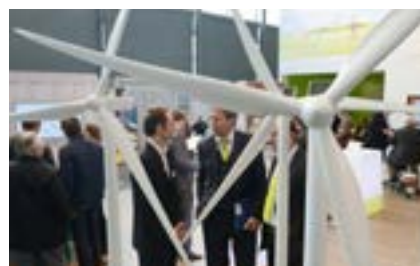

Deutsche Messe AG will not only be presenting the subject of wind at HANNOVER MESSE, but will also be taking it to the ICCI in Istanbul, Turkey, (28–30 May 2019), the SETA, (10 to 12 Oktober 2019) in Bangkok, Thailand, and the CanWEA in Calgary, Alberta, Canada (8–10 October 2019). Both Turkey, Thailand and Canada are emerging markets for wind energy and have ambitious expansion targets.

Deutsche Messe AG will continue its globalisation strategy and open up more attractive marketplaces for its customers in the energy sector through its global network of subsidiaries and representatives.



Deutsche Messe AG

Address	Messegelände 30521 Hannover
Phone	+49 (0)511 89-34116
Fax	+49 (0)511 89-31122
E-Mail	behnaz.shabani@messe.de
Web	www.messe.de
Category	Other services
Profile	Trade fairs & conferences for the wind energy industry
Turnover	more than € 310 million
Employees	more than 1,000
Founding year	1947

Deutsche Windtechnik

Independent full scope O&M provider for multibrand WTG technologies on-/offshore

Deutsche Windtechnik is an independent specialist in the technical maintenance of wind turbines worldwide. Over 1,200 employees ensure that the wind turbines operate reliably around the clock. Our multibrand system engineering focuses on Vestas/NEG Micon, Siemens/AN Bonus, Nordex, Senvion, Fuhrländer, Gamesa and Enercon turbines.

Comprehensive expertise, flexibility and more value for lower costs – this is what sets apart the quality of our service. With our diverse range of core competencies, we are able to offer the full package of services from a single source. We now service over 3,700 wind turbines as part of permanent maintenance contracts (basic maintenance and full service). Our objectives are to ensure technical systems operation and to carry out our work in the most cost-efficient way possible.

Independent O&M worldwide

Our decentralised service network enables us to move swiftly between the customer, the wind turbine and spare parts warehouses. Our company's head office is based in Bremen, Germany. In addition, Deutsche Windtechnik is also active abroad: locations in Denmark, France, The Netherlands, Poland, Sweden, Spain, Taiwan, United Kingdom and the United States provide the foundation for high-quality system maintenance around the world.

Full scope from A to Z

Whether it is the entire wind turbine, the control system, nacelle, rotor or the foundation, from large components to the smallest electronic components or even the substation, our team of experts understands your wind turbine portfolio and can provide economic benefits from a service point of view. Onshore and offshore.

Our range of services includes:

- Individual, needs-based and modular service offering from the basic service to the full maintenance contract, which also covers external damage including major components.
- Repair and optimization
- Expert appraisals for a range of scenarios
- QHSE and project support
- Offshore operations management
- Repowering
- Development and sale of spare parts

All services are freely combinable.



- 01 | More than 300 service teams operate for Deutsche Windtechnik internationally.
- 02 | Deutsche Windtechnik offers a complete service for offshore wind farms as well from foundation, to turbine, to blade, to offshore substation (OSS).
- 03 | Special working platforms and rope-supported access methods enable safe access to the rotor blades



Deutsche Windtechnik

Adress	Stephanitorsbollwerk 1 (Haus LEE) 28217 Bremen
Phone	+49 (0)421 69105-0
Fax	+49 (0)421 69105-499
E-Mail	info@deutsche-windtechnik.com
Web	www.deutsche-windtechnik.com
Category	Operation & Service
Profile	Service, maintenance & repair
Turnover	€ 142 million (2018)
Employees	1,200
Founding year	2004

Dunoair Windpark Planung GmbH

The energy transition comes first

As a specialist for the planning, construction and management of sites for wind turbines in Germany and abroad, DunoAir promotes climate and environmental protection.



- 01 | Entspannt in die Zukunft blicken – Windparkfest in Weibern-Rieden
- 02 | Montage einer Gondel im Windpark Dahlem-Baasemer Wald
- 03 | Company founder Arjen C. F. Ploeg



We are a family-oriented company and safeguarding the future for the generations to come is important to us. The energy transition is an important move towards a time when access to energy is clean, inexhaustible and affordable. This goal strengthens our resolve every day to commit ourselves to wind power.

DunoAir originally began with Arjen C.F. Ploeg as a project buyer. The company developed dynamically in the years that followed and successfully established itself on the market. With the creation of its own planning department in 2009, DunoAir Windpark Planung GmbH, we have finally become a successful full-service company covering the entire value chain. From planning and construction to operation, DunoAir covers all the relevant fields for implementing projects in a serious, prompt and reliable manner.

Qualified and motivated staff are particularly important. They are the reason that DunoAir was able to grow into an international company with offices in Germany, the Netherlands and Ireland, and with projects boasting a total installed capacity of about 184 MW.

Communities and local companies are closely involved in project development and are kept regularly up-to-date. Transparency like this creates trust and forms the basis for good and sustainable collaboration, with a view to adding value at a regional level.

The DunoAir team looks forward to giving investors, planners and operators the benefit of its expertise. Contact us and discover a reliable partner for the successful implementation of your projects.

Dunoair Windpark Planung GmbH
 Adress **Hawstrasse 2a**
54290 Trier
 Phone **+49 (0)651 99 98 89-13**
 E-Mail **c.wuertz@dunoair.com**
 Web **www.dunoair.com/en**
 Category **Planning**
 Profile **Planners & project developers**
 Employees **12**
 Founding year **2004**



EMD Deutschland GbR

windPRO, windOPS, energyPRO, Training and Support

EMD Deutschland is the exclusive sales agency and training provider of EMD International A/S for central europe, the balkan states and the German speaking countries.



windPRO – software for wind energy project design and planning

windPRO is a module-based software package suited for project design and planning of both single WTGs and large wind farms. windPRO covers different areas, from energy yield calculations via wind data analysis, performance checking and environmental impact calculations to grid connection calculation. With its integrated online data services, a user friendly interface and continuous development to integrate new research and knowledge, it is now the world leading software for wind energy project design. User groups include project developers, independent experts, WTG manufacturers, grid operators, banks and authorities.



windOPS – web software for performance analysis of your wind farm

windOPS is a web-based wind power management and analytics software service developed for the daily performance monitoring and to compare, analyse and report operational and financial data for wind farm assets on a regular basis. Present and past operation data of WTGs from different manufacturers are shown in a unified view and summarized in a well-arranged portfolio view.



energyPRO – software for the simulation of distributed energy systems

energyPRO is the most advanced and flexible modelling software for combined techno-economic optimisation and analysis of a variety of heat, CHP, process and cooling related energy projects. In energyPRO you can model virtually any type of technologies from well-known, fossil fuel based production units to state-of-the-art renewables.



EMD Deutschland GbR

www.emd.dk

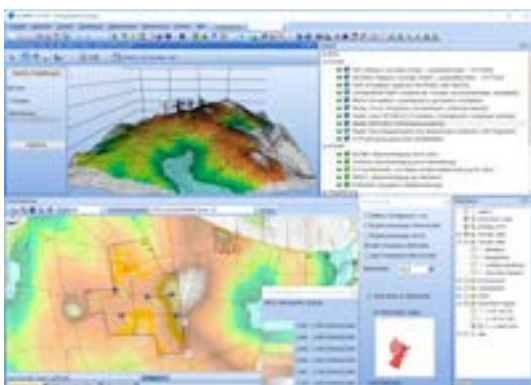

windPRO 3.0 map window with wind resources and 3D view

EMD Deutschland GbR

Adress **Breitscheidstrasse 6
34119 Kassel**
Phone **+49 (0)561 31059-60**
Fax **+49 (0)561 31059-69**
E-Mail **sales-de@emd.dk**
Web **www.emd.dk**
Category **Other services**
Profile **Education & training**
Turnover **> € 5 million (EMD Int.A/S)**
Employees **6 (EMD Germany)**
Founding year **1999**

EnBW Energie Baden-Württemberg AG

A competent partner with expertise available to third parties – also abroad

Whether in the development, acquisition, construction, operation, direct marketing or repowering of wind power plants, EnBW is active both onshore and offshore along the entire value added chain. We focus on developing reliable partnerships in this area and also make our expertise available to third parties as a service provider.



EnBW has expanded its onshore portfolio across Germany so that it now comprises 500 MW. We will also rigorously push forward this expansion over the next few years with an already secured project pipeline of more than 1,400 MW. In addition, EnBW is focussing on existing wind farms that are coming towards the end of their operating lives. From the initial wind farm check and ensuring continued operation through to electricity distribution even outside of the EEG, our range of services also includes purchasing, dismantling and repowering the turbines.

EnBW remains on track for growth both offshore and onshore. We are continuing to focus on the core country of Germany but also on selected markets abroad. In the onshore sector, we are active, for example, in France and Sweden via our national subsidiaries. By purchasing existing wind farms and the rights to projects that are ready for construction, a portfolio of around 100 MW has already been developed. We are also represented on the offshore markets in the USA and Taiwan via our subsidiaries.



We are one of the pioneers of wind energy at sea and our wind farm EnBW Baltic 1 was the first commercial offshore wind farm in Germany in the Baltic Sea. It was then followed by EnBW Baltic 2. We thus have 337 MW of installed output in the Baltic Sea. We are now switching course to the North Sea where we will continue to grow: A further 610 MW is currently under construction in the joint project EnBW Hohe See and EnBW Albatros. The construction of our third North Sea wind farm – EnBW He Dreht – is due to start in 2023.

- 01 | The EnBW Langenburg wind farm with 12 wind turbines
- 02 | The joint project of the EnBW Hohe See and EnBW Albatros offshore wind farms is under construction in the North Sea



EnBW Energie Baden-Württemberg AG

Adress **Durlacher Allee 93
76131 Karlsruhe**

Phone **+49 (0)721 63-15382**

E-Mail **direktvermarktung@enbw.com,
vermarktung20plus@enbw.com**

Web **www.enbw.com, www.enbw.com/direktvermarktung**

Category **Direct marketing**
Profile **Direct marketers**

Turnover **€ 17 billion (9.2018)**

Employees **21,502 (9.2018)**

Founding year **1997**

Energieallianz Bayern GmbH & Co. KG

Consulting and services for the energy transition

Energieallianz Bayern plans, builds and operates wind turbines throughout Germany. As a subsidiary of municipal utility companies and energy cooperatives, we are your long-term partner.

Responsibility for future generations, protection of the world's climate, safe CO2-free energy for people and businesses, electricity produced in the region for the region – there are many reasons to help shape the energy transition. As a committed citizen, a far-sighted community, an innovative company or a responsible investor. We provide you with all these services and our full commitment every step of the way.

Location planning and management

- Examination of location suitability
- Creation of wind farm layouts
- Conclusion of licence agreements
- Security of grid connection and cabling/routing
- Technical planning

Approval procedures and EEG invitation to tender

- Furnishing of all assessments
- Drawing up of approval documents
- Assistance with urban land-use planning
- Planning of compensatory and substitute measures
- Participation in the EEG tender procedure

Contract management and construction supervision

- Procurement of outside capital
- Economic evaluation, negotiation of contracts
- General contracting
- Construction supervision
- Construction inspection and billing
- Warranty testing

Asset management and operations management

- Business management and investment management
- Fulfilment of all reporting obligations and permit conditions
- Independent technical and commercial management
- Data collection and provision
- Supervision and monitoring of all contracts
- Cost and revenue optimisation
- Direct marketing and other forms of marketing

As an installer and operator of our own wind farms, we are familiar with all aspects of the value chain. We can provide advice during every project phase. As a community of numerous shareholders, we understand how to implement cooperation models. We use our creativity to get the most out of your wind farm.

01 | Wind park Zieger, community Velburg, Upper Palatinate

02 | Headquarter of Energieallianz Bayern Gruppe

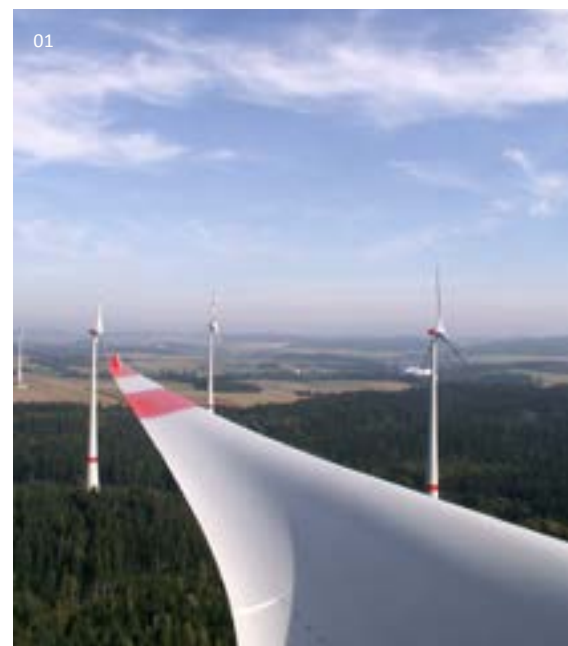

Energieallianz Bayern
GmbH & Co. KG

Address **Ludwigstr. 47
85399 Hallbergmoos**
Phone **+49 (0)811 88991-600**
Fax **+49 (0)811 88991-615**
E-Mail **info@energieallianz-bayern.de**
Web **www.energieallianz-bayern.de**
www.energieallianz-projekt.de

Category **Planning**
Profile **Planners & project developers**
Turnover **€ 10 million (Energieallianz-Gruppe)**

Founding year **2009**



Energiequelle GmbH

Growing number of projects on the international stage

Energiequelle GmbH, headquartered in Kallinchen in the federal state of Brandenburg, is not only a successful project developer on the German market. The company has also been active in other European countries since 2009. For the first time in the company's history, 2019 will see simultaneous construction projects in three countries.



As early as 2009, Energiequelle began looking beyond Germany and commissioned the first wind farm with 6 turbines in France. With the takeover of the current subsidiary P&T Technologie, which is now operated through three offices in France, 86 plants with a total output of more than 160 megawatts have now been built.

New projects in France

Further projects in France are already in the planning stage or have already been partially implemented. In the second half of 2018, the Callac project with an output of 4.8 megawatts went into operation in Brittany. Five other plants are under construction and will be connected to the grid in the first half of 2019. "We also have all the necessary approvals for two further projects in France. Construction is scheduled to start in 2019," says Ronald Bach, head of international projects at Energiequelle. The new plants will also be built in Brittany and the Pays de la Loire and will increase the installed capacity by 35 megawatts. Gregor Weber is the head of projects at Energiequelle and is very pleased with the growing number of projects in France. "Our project pipeline is well filled. The long-term commitment of our company together with our subsidiary is paying off. We can now say that the French market has developed into an important cornerstone for energy sources."



The market for renewable energies in Germany is becoming increasingly difficult. Political developments are constantly presenting the industry with new challenges in the financially attractive expansion of green energy in Germany. However, a pan-European perspective is not only important for climate protection reasons. For Energiequelle GmbH, activities on European markets outside Germany are now an important sales factor.



New projects in Finland

The same applies to the Finnish market, for which Energiequelle made a conscious decision and in which the company sees great potential. The first Finnish wind farm from Energiequelle is currently being built in the North Ostrobothnia region. The company has had an office in Helsinki since January 2016. The new wind farm will generate 75.5 million kilowatt hours of electricity in the future. Partner of the project is the local developer Smart Windpower Oy. The project won't require any state subsidies during operation.

Nils Borstelmann is the project manager for Energiequelle. He is particularly pleased with the good collaboration with local communities and the positive attitude of landowners. "The fact that we were able to get a project to construction readiness in such a short time wasn't necessarily predictable. We first had to get to know and understand the market. This is only possible with an excellent team." The wind farm in North Ostrobothnia is scheduled to be connected to the grid at the end of 2019. Construction of another Finnish project is also scheduled to start in spring 2019. A total of seven new plants with a capacity of around 30 megawatts are due to be built. Two further projects in the far north are planned for 2020.

Simultaneous projects in three countries

With the current projects in Germany, Finland and France, Energiequelle is on course for international success. For the first time in its history, the company has simultaneous construction projects in three countries, supplying a total output of over 50 megawatts of green energy.



Energiequelle GmbH

Address **Hauptstrasse 44
15806 Zossen OT Kallinchen**
Phone **+49 (0)33769 871 100**
E-Mail **info@energiequelle.de**
Web **www.energiequelle.de**
Category **Planning**
Profile **Planners & project developers**
Employees **226**
Founding year **1997**

EWE ERNEUERBARE ENERGIEN GmbH

Wind is our element

Passion meets experience and financial strength: As a trend setter for the energy future in northern Germany, EWE has been the driving force behind the development of renewable energies for 30 years. We are your reliable partner for development, project planning, construction and operational management.

01



EWE – your partner for the future

Wind power is a cornerstone of the future energy supply. EWE has been using the flat terrain and windy conditions in the north of Germany since 1989 to generate electricity from wind. Today we operate nationwide with an onshore portfolio of around 350 megawatts and a comprehensive project pipeline.

EWE ERNEUERBARE ENERGIEN GmbH is a wholly owned subsidiary of Oldenburg-based EWE AG and the competence centre for renewable generation. Our know-how is complemented by the teams in our affiliated companies swb CREA in Bremen, TurboWind in Hanover and Gewi in Husum. Together we are committed to a sustainable energy future. Because wind power depends on acceptance, EWE is committed to dialogue. Our individually planned wind farm projects are welcomed by citizens, local decision-makers and approval authorities.

With EWE ERNEUERBARE ENERGIEN at your side, you are prepared for every challenge. Last but not least, you can count on us as a reliable investor or investment partner.

Our services

- Location planning and management of securing sites to grid connection
- Approval and tender
- Compensatory measures
- Procurement process and construction supervision
- Concepts for participation and financing
- Technical and commercial management
- Cost-optimized operating strategies
- Remote monitoring
- Contract management
- Repowering
- Partner models

Shaping the energy transition together

The wind industry is going through some stormy weather: increasing competition, strong cost pressures, increasingly complex approval procedures and complicated nature conservation and environmental protection requirements. In this market environment, EWE ERNEUERBARE ENERGIEN is a partner who can take on investments and risks and bring a wealth of experience to the table. Added to this is EWE's strong credit rating as a major energy service provider.



**It's all smooth-running with
EWE ERNEUERBARE ENERGIEN**

Whether it's land acquisition, tendering procedures or handling project development risks, cost-effective operating concepts for old wind farms or repowering – the possibilities for productive collaboration with EWE ERNEUERBARE ENERGIEN are immense. We can handle the operation, maintenance and repair of turbines. We develop individual models for collaborations with our partners.

We also handle existing plans, rights or wind farms for wind power companies that want to focus on other projects.

**Cost-effective operation –
even after EEG**

From 2020, EEG funding will cease for thousands of wind turbines. Without fixed remuneration, efficient models for operation and electricity marketing take on a new significance. EWE ERNEUERBARE ENERGIEN is prepared for this challenge: Individual operating concepts for our customers enable manageable costs and at the same time provide safety and value retention. And our sister company EWE TRADING offers tailor-made marketing concepts for electricity.

Our strengths – your gain

One thing is certain: An economic and ecological energy transition can succeed even more as a community project. If you're looking for a successful and reliable partnership, we're right by your side. Get in touch with us!



**EWE ERNEUERBARE ENERGIEN
GmbH**

Address **Donnerschweer Str. 22–26
26123 Oldenburg**

Phone **+49 (0)441 803 4181**

Fax **+49 (0)441 803 4195**

E-Mail **erneuerbare@ewe.de**

Web **www.ewe-erneuerbare.de**

Category **Planning**

Profile **Planners & project developers**

Turnover **€ 68 million**

Employees **95**

Founding year **2013**

01 | Köhlen Wind Farm with 48 MW

02 | EWE team at Hatten Wind Farm

envia THERM GmbH

As an energy producer, envia THERM sets the course for the energy future in eastern Germany to green. As a reliable and service-strong partner for wind energy projects, the company covers all services from project development to construction, repowering and operational management.



01

- 01 | Wind farm in Kolkwitz / Brandenburg
- 02 | Plant engineering for envia Mitteldeutsche Energie AG
- 03 | Value added chain renewable energies



envia THERM GmbH

Address **Niels-Bohr-Straße 2
06749 Bitterfeld-Wolfen**
 Phone **+49 (0)3493 5167-0**
 Fax **+49 (0)3493 5167-4402**
 E-Mail **info@envia-therm.de**
 Web **www.envia-therm.de**
 Category **Planning**
 Profile **Planners & project developers**
 Turnover **€ 127 million (2018)**
 Employees **161 (2018)**
 Founding year **2006**

envia THERM is a wholly owned subsidiary of envia Mitteldeutsche Energie AG (enviaM), currently the leading regional energy provider in eastern Germany. The company has many years' experience in energy production and combines all the generation activities of the enviaM Group. The portfolio includes bioenergy, photovoltaics, hydropower and wind energy at around 70 locations.

envia THERM's aim is to actively shape the energy transition in eastern Germany by expanding and developing renewable energies. As a competence center for regenerative energies, the energy service provider has a wide range of technologies as well as extensive expertise along all project development stages, from site



02

analysis to the construction and repowering of wind turbines. The same applies to operations – from contract management and direct marketing to commercial and technical operations management and repowering of wind turbines.

In addition to in-house development of wind farms and implementation of cooperation projects, envia THERM is also interested in acquiring project rights and purchasing equipment. The company is particularly keen on establishing confidence with local players and developing a sustainable collaboration with their full involvement. This includes individual participation concepts for citizens, local authorities and utilities.

envia THERM is a reliable and service-oriented partner for plant operators, project developers, local authorities and utilities with the necessary experience and competence to implement energy transition projects reliably and in full partnership with its clients.

03



FGH – Forschungsgemeinschaft für elektrische Anlagen und Stromwirtschaft e.V

For a secure grid connection of your wind energy project

Your experienced partner for a reliable grid integration: accredited measuring & certification, on-site inspections and electrical engineering services

100 years of research & development

We have been providing customized research and development services for all aspects relating to electricity supply for almost 100 years. The reliable and secure integration of renewable energy sources into the power grids has become one of our core topics within the past 30 years.

Accredited measuring & certification

For manufacturers and project developers our accredited testing laboratory provides conformity and type testing according to custom-specific and standardized specifications. For this purpose we provide a unique test site also including the opportunity of LVRT and HVRT testing. The portfolio is completed with independent certification services by our certification body. Being the world's first accredited institution in this field, nowadays we are market leader for grid code compliance certification of generating units, plants and corresponding components and products.



Inspection body

As a perfect complement our inspection body offers customized on-site testing and inspection services for compliance monitoring, such as testing of protection devices, conformity declarations and assessment of electrical equipment.

Electrical engineering services

Furthermore we provide comprehensive engineering services for manufacturers, project developers and grid operators. These services include e.g. grid and system studies, planning and engineering of electrical layouts, development and implementation of simulation models in several software environments and engineering of mobile fault-ride-through (FRT-) testing laboratories.



- 01 | Reliable grid integration of all technologies: wind energy, photovoltaics, combined heat and power
- 02 | Pioneering grid code compliance
- 03 | Accredited testing laboratory and certification body



FGH – Forschungsgemeinschaft für elektrische Anlagen und Stromwirtschaft e.V

Address **Besselstr. 20–22
68219 Mannheim**

Phone **+49 (0) 621 976807-50**

Fax **+49 (0)621 976807-70**

E-Mail **info@fgh-ma.de**

Web **www.fgh-ma.de**

Category **Experts**

Profile **Certification**

Turnover **€ 10 million**

Employees **82**

Founding year **1921**

Fichtner GmbH & Co. KG

Engineering and Consultancy for Wind Farms All Over the World

For decades, Fichtner has been using the experience it has gained in all aspects of sustainable energy generation and utilization to oversee all phases of onshore and offshore wind power projects.



- 01 | As Owner's Engineer Fichtner supports in all technical as well as economical questions for instance for an 80 MW wind park in Jordan
- 02 | As Lender's Engineer Fichtner develops due diligence reports for instance for a wind park portfolio in Central America

FICHTNER

Fichtner GmbH & Co. KG

Address **Sarweystrasse 3
70191 Stuttgart**
 Phone **+49 (0)711 8995-0**
 Fax **+49 (0)711 8995-459**
 E-Mail **info@fichtner.de**
 Web **www.fichtner.de**
 Category **Planning**
 Profile **Planners & project developers**
 Turnover **€ 246 million (Group)**
 Employees **1,500 (worldwide)**
 Founding year **1922**

Fichtner is Germany's biggest independent engineering and consultancy enterprise for infrastructure projects in the sectors of energy, water, environment, traffic engineering, and IT.

Many decades of experience

Fichtner has been playing an active role in the success story of wind energy since the 1980s. For example, Fichtner as owner's engineer rendered consultancy services for the first wind farms in Germany, and advised the German Research and Development Ministry on its first wind energy program.

International project teams covering all disciplines

Today, the Fichtner Group offers a network of highly qualified engineers and consultants with expertise in all aspects of onshore and offshore wind energy.

Fichtner's experts are equally conversant with the challenges of German and international investors and development banks as they are with local energy supply markets, tariff structures and permit application procedures.

Broad range of services

As owner's engineer, Fichtner assists its clients in all technical and commercial aspects, from initial project idea up to wind farm commissioning. As lender's engineer, Fichtner prepares due diligence reports and oversees project realization and commissioning.

Specific services

- Owner's engineer in all phases of onshore and offshore projects
- Geotechnics and morphodynamics
- Scour protection, jacking appraisals and pile dynamics
- Due diligences
- Layout and permit planning
- Wind measurements, wind studies and energy yield assessments
- Operation and maintenance concepts
- Inspections
- Analyses of residual service life



fos4X GmbH

We provide sensors and information to drive smart wind energy

Visions become reality: As a IIoT company, we offer solutions for digitizing and increasing the efficiency of existing plants based on reliable sensor technology. Our forward-looking technology guarantees state-of-the-art analytics and individually optimized operation of wind turbines.



Digital transparency for future-oriented action

The goal is clear: costs and risks down, returns up! Everyone is talking about the fact that the analysis of operating data is an important lever for this. However, the wind turbines do not yet have a modern digital infrastructure that enables access to relevant, dynamic data in real time. This begs the question: how can data be automated into instructions for action?

The digitization of wind energy is becoming reality

Self-learning algorithms and predictive methods make it possible to optimally control wind turbine networks. Data is captured and delivered in real-time in a cloud environment. Depending on the application, the data is either analyzed directly on site or after being transferred to a cloud. The operator receives up-to-date information on the performance and condition of his or her wind farm at all times. In addition to existing data, we generate „smart data“ based on sensors from the rotor blades. Strains and vibrations are measured where they occur – directly on the rotor. They are an essential source of data for the turbines “digital twin”.

Increasing efficiency using the retrofit solution

retroX is our manufacturer-independent retrofit solution that operates four levers to increase the profitability of wind turbines. These are:

- Reduction of operating costs
- Risk mitigation
- Increase of annual energy production
- Preparation for continued operation

The initial investment for retroX hardware is very low, so that a quick return on investment is achieved.

fos4X
rotor blade sensing

fos4X GmbH

Address **Thalkirchner Strasse 210
81371 München**
Phone **+49 (0)89 999542-00**
Fax **+49 (0)89 999542-01**
E-Mail **info@fos4x.de**
Web **www.fos4X.de**
Category **Other services**
Profile **Software solutions**
Employees **100**
Founding year **2010**

Framatome

Service with quick response, flexibility, expertise and innovative solutions

Framatome stands for CO₂-free energy production and has been supporting the wind energy sector for years with its technological expertise in various fields, accredited powerful labs and quality assurance. Competence from 60 years in energy plants business forms the basis for innovative solutions.



- 01 | Final Acceptance Test: Performing non-destructive mobile cleanliness check and ultrasonic testing on a rotor main bearing's outer ring.
- 02 | FLAT-UT®: Offshore and onshore ultrasonic testing of rotor main bearing in assembled condition
- 03 | Root Cause Analysis: failure pattern prior to analysis of relevant wind turbine components, and electron microscopy in our laboratories

Failures and quality issues on functionally relevant components compromise the reliable operation and often result in high cost. With our 24/7 services we offer very short reaction and processing times where our experienced material experts utilize their competences for root cause analysis and prevention of failures. This is supported by a state-of-the-art laboratory infrastructure that also includes mobile equipment for on-site analyses. Processes and procedures are certified according to EN ISO 9001 and accredited according to EN ISO/IEC 17025.

Jointly with our customers we elaborate interdisciplinary approaches and remedial actions. By doing so we take advantage of a broad spectrum of different engineering disciplines and accompany the action implementation.

We offer in-situ ultrasonic examination techniques particularly developed for off-shore component inspections that do not require dismantling, hence ensuring long-term operation.

Framatome assists its customers through quality assurance. We inspect and assess components regarding quality and fitness for service also on-site directly at the manufacturers' premises.

As an example, in recent years we have analyzed off-shore main bearing failures. Through targeted forensic analyses on entire bearings, the relevant mechanisms were identified and remedial countermeasures were defined.

We provide consulting services with respect to materials and welding regarding selection, application and analysis, and also perform fitness-for-service assessments.

Diagnosis and monitoring systems for fatigue monitoring as well as remotely controlled inspection submarines round up the entire service portfolio.

How can we meet your needs?



Framatome GmbH

Address **Paul-Gossen-Str. 100
91052 Erlangen**
 Phone **+49 (0) 9131 900-31548**
 Fax **+49 (0)9131 900-94020**
 E-Mail **wind@framatome.com**
 Web **www.framatome.com/
solutions-portfolio/wind**
 Category **Operation & Service**
 Profile **Service, maintenance & repair**
 Turnover **€ 3.3 billion
(Framatome worldwide)**
 Employees **14,000 (Framatome worldwide)**
 Founding year **1958**

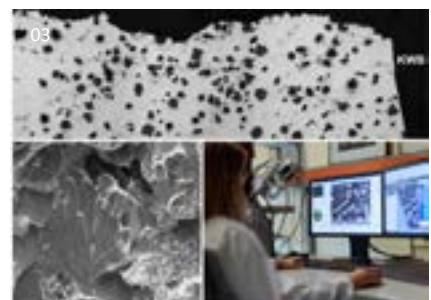
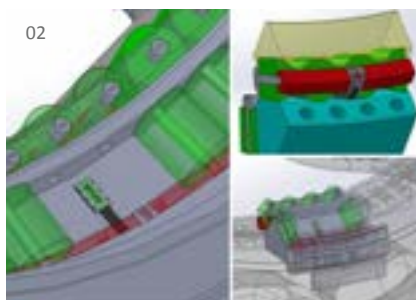

GAIA mbH

Everything from a single source – that's our claim

For 20 years, customers and partners appreciate our competence and reliability in planning, development, project coordination, service and operational management of wind turbines and photovoltaic systems.

We, the Gesellschaft für Alternative Ingenieurtechnische Anwendungen, short GAIA, are pioneers of renewable energy in Rhineland-Palatinate. Our core competences are the planning and construction of wind energy and solar power systems as well as the development of individual sustainable energy concepts.

After the successful completion of a project we take over the operational management for wind turbines, wind farms and photovoltaic systems and offer service and maintenance. Storage solutions, charging systems for E-mobility and drone-based services such as inspections, monitoring, aerial photography, mapping, documentation and 3D visualisations of your projects complete our portfolio.

Established in 1999 by Dipl.-Kfm. Torsten Szielasko and Dipl.-Ing. Michael Wahl as an engineering company, GAIA currently employs 50 highly dedicated and qualified members of staff, whose daily work contributes to sustainable energy generation and thus to environmental protection.

Holistic, ecological, flexible

Everything from a single source – The keystone of GAIA's business philosophy. Our customers appreciate us because we combine all the processes required for wind energy and solar projects: From initiation to the turnkey handover to the operator, we take care of all aspects of project management.

Many customers also use our broad spectrum of our individual services: Our GIS-based analyses help you to find and evaluate the potentials of the project, to identify project risks early on and to optimize the site configuration. The project and evaluation team will accompany you at every stage of development, identify project risks at an early stage and ensure the success of your project or project acquisition. We accompany and control your project during the construction phase. Always with the aim of reducing construction costs and minimizing risks, we will find innovative solutions to challenges of your project.



- 01 | "What drives us – local clean energy – over 20 years"
- 02 | Wind turbine in Tiefenthal: Technical management with drone-based services.
- 03 | GAIA headquarters: An historical, now surplus energy building



GAIA mbH

Adress **Jahnstr. 28
67245 Lamsheim**
 Phone **+49 (0)6233 359440-0**
 Fax **+49 (0)6233 359440-1**
 E-Mail **info@gaia-mbh.de**
 Web **www.gaia-mbh.de**
 Category **Planning**
 Profile **Planners & project developers**
 Turnover **€ 5.5 million**
 Employees **50**
 Founding year **1999**

GfM Gesellschaft für Maschinendiagnose mbH

We keep your drive running!

GfM Gesellschaft für Maschinendiagnose mbH offers online condition monitoring, offline drive train diagnosis as well as gear endoscopy, blade bearing diagnostics and foundation monitoring.

01



In order to meet the high expectations of availability of wind turbines, maintenance has a major influence, in addition to the product quality of the drives. It is important to know predictively what will happen to the drive, which components will have used up their wear margins at what time. The usual dismantling and new bearing of a drive every few years cannot provide such a view into the future. This requires tools that provide status information every few days or hours.

Vibrations contain a lot of information, especially about mechanical phenomena. They spread very well, are easy to measure and to interpret. Thus, the damage state of rolling bearings and gears can be reliably determined by means of vibrations. Condition monitoring systems work on the basis.

GfM offers the online condition monitoring system Peakalyzer, which does not require a learning phase and detects and reports damage states fully automatically. For mobile measurements, the 12-channel PeakStore5 system is available. Of course, in addition to the hardware products, the

corresponding services are offered. Moreover, for those who are interested, the GfM conducts comprehensive seminars twice a year.

For monitoring rotor blade bearings GfM developed the BladeBearingAnalyzer and for foundation monitoring the BaseAnalyzer. These systems can be applied independently or in combination.

The GfM is independent. There exist absolutely no commitments to replacement part distributors, maintenance companies or insurance companies for the drive engineering. The diagnosis and expert reports are consequently neutral.

- 01 | PeakStore5
- 02 | Peakalyzer with overvoltage protection
- 03 | Waterfall chart
- 04 | Spectrogram

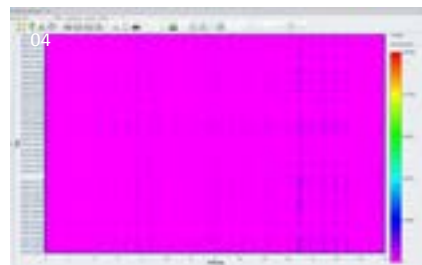

GfM Gesellschaft für Maschinendiagnose mbH

Adress **Köpenicker Strasse 325
12555 Berlin**

Phone **+49 (0)30 65762565**

Fax **+49 (0)30 65762564**

E-Mail **mailbox@maschinendiagnose.de**

Web **www.maschinendiagnose.de**

Category **Operation & Service**

Profile **Service, maintenance & repair**

Founding year **1999**

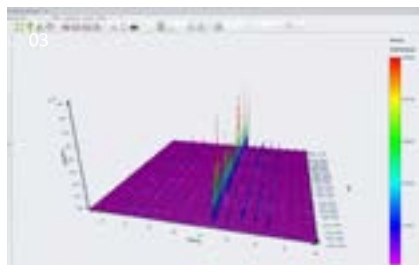

GP JOULE GmbH

We develop values: From green field to electricity and hydrogen station.

GP JOULE is your reliable partner for integrated management and development of energy projects, for successful implementation of projects based on our expertise, experience and reliability at every phase – from securing the location to continued operation, including post-EEG.



Since we were established in 2009, we have installed over 650 megawatts of renewable power plant capacity in Germany and abroad and now ensure the smooth operation of 600 megawatts in technical and 400 megawatts in commercial operations.

GP JOULE also stands for expertise across the entire value chain of renewable energies and offers a full range of services from project development to wind power upgrading through Power-to-X in hydrogen, heat and mobility.

Landowners and municipalities benefit in a special way from our broad range of services. We carry out projects together and our background in agriculture means that our approach to the land as a precious resource is particularly respectful.

Wind farm operators optimise and secure their returns through our experienced technical and commercial management with a modular range of services and ISO-certified quality. Operators of old plants will continue operating with us – in addition to the repowering option, GP JOULE has extensive project experience in post-EEG operation through its expertise in electricity conversion to hydrogen and in electricity marketing.

Investors benefit from our expertise as project planners and operators, our direct and exclusive access to the market and from intelligent usage models with added value. We offer you sustainable investment strategies for value creators.

GP JOULE
TRUST YOUR ENERGY.

GP JOULE GmbH

Address **Cecilienkoog 16
25821 Reußenköge**
Phone **+49 (0)4671 6074-0**
E-Mail **info@gp-joule.de**
Web **www.gp-joule.de**
Category **Planning**
Profile **Planners & project developers**
Employees **220**
Founding year **2009**



Unsere Investition in Qualität:
GP JOULE SERVICE ist gemäß ISO 9001 zertifiziert.

Green Wind

Green Wind – Development and Technology. With the power of wind

Green Wind specializes in project development as well as the technical and commercial operation of onshore and offshore wind turbines and the platform management of HVDC and substations. Based in Berlin, Green Wind boasts *greenwind control* – an independent, state-of-the-art 24/7 control center.

independent. The Control Center.

greenwind control represents the nerve center of our 24/7 monitoring of equipment used to generate and distribute electric power and the factors influencing its operation, such as sea state and wind/weather conditions. Furthermore, all events are recorded, faults are dealt with, and planned maintenance/repair work coordinated.

innovative. Best Practice.

greenwind control monitors all processes in full. As one of two partners, Green Wind handles the entire maintenance management spectrum for the 900 MW grid connection system in the North Sea. Our specially developed system for this project can also be applied to large-scale projects in the North and Baltic Seas, as well as on the British and French coasts. A further specialty is the programming of “digital twins.” Therefore, the *greenwind control* center software currently includes the digital twins of two substations, as well as the corresponding wind turbines and internal grid infrastructure (onshore and offshore).

intelligent. The System.

Our customers benefit from our manpower and our intelligent systems, without having to bear the investment costs. We integrate stand-alone systems to make their lives easier – something that we call “control center sharing.” Operations managers and independent service providers use our technology and personnel, for example, 24/7, allowing them to offer their customers efficient, around-the-clock monitoring.

inspired. Control Center Operators.

We bring ideas to life, whether training control center operators, providing independent advice to investors, or managing structural development and workforce expansion in the field of monitoring systems for major energy suppliers. We have a close network, which provides inspiration and opens up new possibilities in terms of both technical and commercial management. Intelligent technology is one side of the equation. The expertise, ingenuity, and dedication of our team are the other.

01





02



01 | The Berlin control center

02 | Maintenance management of the 900 MW DolWin3 grid connection system

Specifications and Services

- Staffed 24/7 by expert personnel who are specialized in electrical engineering and mechanics to guarantee a direct and competent technical support line at all times
- Tried-and-true industrial technology and software used to monitor networks and generation equipment – reliable and proven
- Visual diversity thanks to a big screen and workplace monitors, as well as separate optic and acoustic alarm systems (fault warnings)
- Connection to remote control systems by means of various interfaces (e.g. database protocols, IEC 104 standards, OPC standards)
- Dedicated development unit that is able to incorporate projects in a customized manner and implement customer requests in close consultation
- The creation of “digital twins” for all kinds of project levels and areas, such as electrical networks and their distribution points, showing individual generation units, the entire generation system, and synchronous grids

Safety First

Our IT expert and Head of Quality Management Andreas Texheimer is responsible for data security and emphatically states that *greenwind control* boasts two linked control center systems that are capable of replacing each other. Further security measures include:

- All data stored on servers in Germany, regular backups on separate and secured local storage media
- Switch operations and the creation of switching instructions possible (extended access rights)
- The Green Wind system can be disconnected at any time
- Ongoing implementation of safety standards, selection of external suppliers with IT security management systems
- Secure buildings and individual rooms

Certified in accordance with ISO 9001, with preparation underway for ISO 14001, ISO 55000, and ISO 27001



Green Wind Operations GmbH
Green Wind Offshore GmbH

Address **Alt-Moabit 60a**
10555 Berlin
Phone **+49 (0)30 351 2886 30**
Fax **+49 (0)30 351 2886 33**
E-Mail **berlin@greenwindoffshore.de**
berlin@greenwindoperations.de
Web **www.greenwind.berlin**
Category **Operation & Service**
Profile **Service, maintenance & repair**
Technical & commercial operational management
Employees **35**
Founding year **2008**

greenmatch AG

Web-based Renewable Energy Finance Software

With greenmatch you can structure, manage and transact your investments in wind energy, photovoltaics, hydropower and biomass in a reliable and efficient way.



Greenmatch provides comprehensive software solutions for all market participants that need to manage the investments and financials of their renewable energy assets. The platform is based on a standardized and certified cashflow model and connects project developers, investors, lenders and advisors around the globe.

With our products you will get everything you need for the financial valuation and management of your projects.

GM Asset Controlling (New) – Managing financial performance

With GM Asset Controlling you keep track of the financial performance of your projects and your portfolio, compare them with the original plan and take measures when needed.

GM Services – Get expertise

Our team offers strong expertise in renewable energy project finance and deep product knowledge. We make sure you get the best value out of greenmatch!

green[::]match

GM Valuation – Reliable project valuation

GM Valuation is an intuitive cashflow model to value and simulate projects in a standardised and comparable way. Time-consuming and error-prone spreadsheets are no longer needed.

GM Marketplace – Acquisition and sale of projects

GM Marketplace allows you as a project developer or owner to offer your asset to the greenmatch community. As a buyer, the digital marketplace regularly offers new investment opportunities.

Register today at www.greenmatch.ch and explore the possibilities of the greenmatch product suite. Our experts are happy to support you in all questions regarding our products and all topics in project finance. We look forward to welcoming you to the greenmatch community soon!

greenmatch AG

Address **Hebelstrasse 52
4056 Basel, Switzerland**

Phone **+41 (0)613 0150 00**

E-Mail **info@greenmatch.ch**

Web **www.greenmatch.ch**

Category **Other services**

Profile **Software solutions**

Employees **13**

Founding year **2013**

Grzib Elektrotechnik GmbH & Co. KG

Electrotechnical full-service provider. More than 20 yrs of experience in the European wind industry

We are not only available in Germany, but also in other European countries: So far, we have successfully expanded and installed around 2,700 wind turbines all over Europe.

The requirements of planning and erecting a wind farm are diverse. Especially external partners need to be reliable, flexible and professional, demonstrating their work experience at its best in order to complete these projects successfully and failure-free.

You will find us a qualified and flexible partner with respect to wind power electrics.

We know the challenges of major projects and are therefore able to offer you customer-oriented services to avoid disturbances and difficulties.

Our range of services during new construction projects and repowering includes:

- Working in the low-voltage range:**
 Visible installations such as inner and outer tower lightning, connections of switches and sockets, etc., cabling of power cables, e.g. connecting the inverter to the transformer, and implementing transformer and plant protection.
- Working in the medium-voltage range:**
 Connection of medium-voltage switchgear to the transformer, commissioning of transformers and medium-voltage switchgears, switching operations in the medium-voltage range up to 36 kV.
- Implementation of earthing and lightning protection concepts.**
- Working in the field of measurement and control technology:**
 Cabling of superior parking controllers and their signal exchange.
- Maintenance and Service**
 of transformers, medium-voltage switchgear and converters.

Other services

such as delivery and installation of cable support systems in steel and hybrid towers, WTG-specific safety equipment or pre-assembled medium-voltage cable bridges according to customer requirements.

We have convinced our customers with our flexibility, know-how, huge industry experience and high safety standards.

For more information go to www.grzib-elektrotechnik.de



01 | Lothar Grzib | Founder & Director
 02 | Andreas Grzib | Director

Grzib Elektrotechnik GmbH & Co. KG

Address **Zur Kokerei 21
46117 Oberhausen**

Phone **+49 (0)208 884 839 24**

Fax **+49 (0)208 884 839 26**

E-Mail **info@grzib-elektrotechnik.de**

Web **www.grzib-elektrotechnik.de**

Category **Operation & Service**

Profile **Service, maintenance & repair**

Turnover **€ 3.5 million**

Employees **25**

Founding year **1998**

Hamburg Commercial Bank AG

International project financing for renewable energies and corporate finance in the energy and renewables sector

We have been a reliable partner for the growing renewable energies sector for over 25 years. We know and understand the markets and their dynamics and support our clients with tailor-made products in Germany and abroad.



01 | “For more than 25 years, our clients have known that they can rely on us when implementing their wind or solar projects.” Nils Driemeyer

Hamburg Commercial Bank and its precursor institutes have been involved with renewable energies for over a quarter of a century. When many still considered the industrial expansion of wind energy unrealistic and a somewhat crazy idea, we had already financed the first wind turbines in Northern Germany. Even back then we were convinced of the opportunities offered by this type of energy generation – both from an economic and environmental perspective. Our views on this have never changed.

This is why we remain closely connected to a sector which has shown strong growth and plays a key role in reaching global climate targets. In Europe we are one of the leading financiers for renewable energies. From our German home market, which remains important to us, we have long since expanded into neighbouring European countries. We are also available for projects in other countries – especially Asia has interesting markets with continuously high annual growth rates.



Renewable energies



- Manufacturers, project developers and investors trust our strong **advisory and structuring expertise**
- One of the top financing institutions in Europe for **renewable energies and suppliers**

- A comprehensive product portfolio**
- Structured project and company financing
 - risk hedging
 - Management of transactions and liquidity
 - Advisory competence in the field of corporate finance
 - So far we have financed more than 6 GW from renewable energies
 - Credit portfolio of around 4.6 billion euros in 2018

We support projects in the asset classes of wind onshore, wind offshore, solar and hydropower. Our financial solutions are based on a profound understanding of our partner's business and their aims. We offer operating credit lines, short and long term project financing, liquidity management and a range of products related to risk management. We are also well versed in financing in the area of market price risks. Additionally, we support our clients with the purchase and sale of projects and companies, and in finding and negotiating power purchase agreements for projects with market price risks. Manufacturers, project developers and investors trust our high competence in structuring and expert advice.

We know and understand markets and their dynamics which are influenced by technical, legal and structural change. Our deep knowledge of the sector is regularly underscored by the publication of various industry reports on relevant future issues such as Power Purchase Agreements (PPA), financing of wind energy projects with state export credit guarantees (ECA cover) or "electricity market design 2.0". These industry reports are always well received by the market.

Financing projects in the field of renewable energies will remain a growth area for Hamburg Commercial Bank. Our portfolio comprises corporate clients and around 230 projects with a financial volume of more than 4.6 billion euros. The market continues to hold great potential – just as there is a continuing need to generate our energy sustainably and as climate-friendly as possible. The sector has matured as it is now possible almost everywhere in Europe to implement renewable energy projects without state support.

This creates new challenges and business models. We are keen to use our expertise to produce innovative solutions that meet the changing needs of our clients.



**Hamburg
Commercial
Bank**

Hamburg Commercial Bank AG

Address **Gerhart-Hauptmann-Platz 50
20095 Hamburg**
Phone **+49 (0)40 3333-0**
Fax **+49 (0)40 3333-34001**
E-Mail **nils.driemeyer@hcob-bank.com**
Web **www.hcob-bank.de**
Category **Finance & Law**
Profile **Banks, financial institutions &
financial service providers**

WindEnergy Hamburg / Hamburg Messe und Congress GmbH

the global on- & offshore expo

With more than 1,400 exhibitors from roughly 40 countries, WindEnergy Hamburg is the wind industry's most important platform as wind power continues its conquest of the world.



01

Just as important are the networking opportunities with internationally-operating companies and wind industry associations ready to share strategies for project implementation in highly heterogeneous markets. With its innovative focal topics, WindEnergy Hamburg reflects the future of wind energy production, integration and storage.

In addition, the trade fair showcases solutions for sector coupling, the use of wind power for mobility, heating and industrial applications. The world's leading wind industry expo is thus a major force driving the global energy transition towards its ultimate goal – a carbon-free energy supply for the world.



When the world's leading onshore and offshore wind industry expo takes place for the fourth time from 22 to 25 September 2020, all the key players of the industry will be present, along with specialised suppliers and start-ups representing every section of the value chain.

As before the fair organisers expect around 35,000 industry visitors to attend the 2020 fair in the Hamburg Messe exhibition halls. The global WindEurope conference held in parallel with WindEnergy Hamburg at the exhibition site is a perfect match for the trade fair. Every two years the industry's two top events, the world's leading expo for wind energy and the high-level conference, join hands for the Global Wind Summit in Hamburg. For further information please go to windenergyhamburg.com

Product launches by major wind turbine manufacturers and component suppliers will be high on the agenda of WindEnergy Hamburg, as will be presentations of services custom-tailored to address specific challenges encountered in onshore and offshore wind installations.



02

- 01 | From 22 to 25 September 2020, WindEnergy Hamburg will be the global meeting place of energy experts from around the world.
- 02 | International industry leaders and specialised suppliers to the entire value chain will present their innovations and services for the onshore and offshore wind industry.

WindEnergy Hamburg / Hamburg Messe und Congress GmbH

Address **Messeplatz 1
20357 Hamburg**

Phone **+49 (0)40 3569-2263**

Fax **+49 (0)40 3569-692263**

E-Mail **andreas.arnheim@hamburg-messe.de**

Web **www.windenergyhamburg.com/en**

Category **Other services**

Profile **Trade fairs & conferences for the wind energy industry**

Employees **more than 300**

Founding year **1972**

HUSUM Wind

Messe Husum & Congress GmbH & Co. KG

The German Trade Fair and Congress

We take wind a step further. From 10 – 13 September, HUSUM Wind, the wind industry's leading national trade fair, is showing what will define the industry in the future.

From 10–13 September 2019 the Who's Who of the wind industry will once again be coming together in the far north, in Germany's leading model region for wind energy. The trade fair in Husum is expecting 650 exhibitors and 18,000 trade visitors, and with **priority themes such as Power-to-X, digitalisation and post-EEG solutions**, the fair will provide a platform for the wind power of tomorrow.

The trade fair has always been known for its practical relevance, diverse variety of exhibitors ranging from dynamic start-ups to all the important OEMs, and the unique and very personal HUSUM spirit. In short: HUSUM Wind picks up on issues that move the domestic market, while the accompanying congress programme presents new prospects that are opening up through innovation and new business models.

HUSUM Wind sees itself as the shop window for the German innovative business base and as a **dialogue platform for representatives of the business, political and civil sectors**. The exhibition programme once again includes themed tours and excursions to interesting model projects at this North German location for innovation. The show is rounded off with the forum for young, innovative enterprises and with Windcareer, Northern Germany's most important career and recruitment platform for professionals and industry entrants.

Next trade fair:
14 – 17 September 2021



- 01 | The accompanying congress programme presents new prospects that are opening up through innovation and new business models.
- 02 | HUSUM Wind sees itself as the shop window for the German innovative business base.
- 03 | Priority themes are Power-to-X, digitalisation and post-EEG solutions.
- 04 | From 10–13 September 2019 the Who's Who of the wind industry will once again be coming together in Husum.



HUSUM Wind / Messe Husum & Congress GmbH & Co. KG

Address **Am Messeplatz 12–18
25813 Husum**

Phone **+49 (0)4841 902-0**

Fax **+49 (0)4841 902-246**

E-Mail **info@husumwind.com**

Web **www.husumwind.com**

Category **Other services**

Profile **Trade fairs & conferences for
the wind energy industry**

Employees **40 (Windenergy: 10)**

Founding year **1989**

in.power GmbH

Direct marketer from the very beginning, experienced, innovative and independent

As a pioneer in direct marketing the in-power group offers numerous services. Whether it is direct marketing, meter operation, continued operation or regional green electricity products for end users – we are your partner!



Based in Mainz, the **in.power group** has been involved in the direct marketing of renewable and environmentally friendly energies since 2006 as one of the first companies in Germany. The company name is derived from “independent power” and is an expression of the explicit independence of the company. **in.power GmbH** has various subsidiaries that offer a wide range of services related to direct marketing.

in.power metering GmbH is an independent meter operator for renewables and for commercial users. Apart from online data logging and an in-house web portal that allows you to view all relevant data and the profit generated for each unit, the subsidiary also provides for remote control.

The subsidiary **grün.power** supplies green electricity regionally and nationally based on simultaneous full supply from solar, wind and hydropower. This form of distributing green electricity to end users also offers new opportunities for the continued operation of units more than 20 years old.

in.power optimise GmbH offers innovative full services for optimising consumption forecasts (day ahead, intraday) for large commercial and industrial customers to minimise the risks and costs associated with balancing energy. It does so on the basis of calibrated online metering technology and intelligent consumption forecast models.

in.power balance GmbH will soon be responsible for the field of balancing energy derived from wind turbines and PV systems.

in.power network GmbH is a platform for joint ventures that offers a range of services and direct market access to market partners. It is also a highly specialised incubator for new, innovative subsidiaries. A first example is max.power GmbH, a joint venture of the construction company Max Bögl and in.power network GmbH.

in.power

in.power GmbH

Address **An der Fahrt 5
55124 Mainz**
Phone **+49 (0)6131 69657-0**
Fax **+49 (0)6131 69657-29**
E-Mail **kontakt@inpower.de**
Web **www.inpower.de**
Category **Direct marketing**
Profile **Direct marketers**
Employees **about 15**
Founding year **2006**



01 | Founders, holders and managers of in.power group: Josef Werum (left) and Matthias Roth (right)

02 | Team of in.power-group

Koopmann Group

Professional Service for Energy Distribution

The Koopmann Group is one of Germany's leading specialists for energy and electrical engineering. Wind industry services: Cable testing, power plant assembly, circuit breaker servicing, testing & diagnosis, transformer servicing, power centres, protective engineering and operational management

Our wind power services include comprehensive planning and project support, installation, maintenance, servicing and repair as well as the delivery of turnkey distribution and switching stations. Our scope of activities includes the installation of new switching stations, cable lines and transformers up to 110 kV. The installation services are supplemented by commissioning, periodic inspections and preventative maintenance checks. In addition, we carry out standards-compliant earthing measurements and network analyses. We have made technical and personnel investments in our transformer service and own our own oil laboratory in which we carry out and evaluate all VDE oil analyses. We can provide a wide range of on-site services on transformers of any size using our mobile oil treatment plants.

Our core competencies include cable testing and diagnosis.

Our equipment set includes cable measuring and diagnostic vehicles as well as mobile systems including fault pre-location and pinpointing, TE measuring systems, HV test systems up to 250 kV, the CPC 100 test system and devices for insulation, transmission ratio, winding resistance and



dielectric frequency response measurement for transformer testing. Our cable test van, "The Beast" **currently has the world's most powerful VLF testing system** for cables of up to 100 km in length and 60 kV with a buffer for MV and HV cables. We also have a high-performance measurement system in an ocean-going container at our disposal for the accurate location of on- and offshore cable faults. We can also take on the operational management of power and electrotechnical infrastructure systems.

Our professional and technically well-equipped team is available 24/7 to ensure the safe and long-term operation of your energy supply facilities.

- 01 | High performance measuring system in a sea container, cable test van "The Beast", locations, business segments
02 | 100 kV partial discharge measuring system



Koopmann Group

Address	Zum Brook 19–21 49661 Cloppenburg
Phone	+49 (0)4471 9494-0
Fax	+49 (0)4471 84895
E-Mail	info@hk-c.de
Web	www.hk-c.de
Category	Operation & Service
Profile	Service, maintenance & repair
Turnover	about € 39 million
Employees	about 230
Founding year	1982

juwi AG

Energy is here

juwi AG – Project Development with Competence, Experience and Passion. juwi implements renewable energy projects cost effectively and reliably – from the initial idea to commissioning. We lease land, plan plant and infrastructure, obtain permits, order components and build the wind farm. We also deal with project rights.



Competent and experienced partners

juwi is one of the leading specialists in wind and solar energy projects. In numerous projects we have demonstrated our strength as a collaborative partner for regional project developers, energy suppliers and energy cooperatives. Together with our parent company MVV Energie AG, we also have extensive expertise in direct marketing and in the electricity trade. Our long-term collaborations with all the major turbine and component suppliers are our guarantee for reliability.

juwi was founded in 1996 in the Rheinland-Palatinate region in Germany. Around the world, the juwi group employs some 850 staff on every continent. Around 1,000 wind turbines and over 1,700 photovoltaic plants clearly demonstrate our 22 years of expertise in the field of renewable energies. In 2018, juwi won more than 130 megawatts of contracts, making it one of the winners of the new wind energy subsidy system.

Complex sites and repowering

Across Germany, juwi has installed 800 wind turbines with a rated capacity of over 1,900 megawatts; in many cases with the **participation of citizens and municipalities**. Including on highly complex sites with a hilly or forested terrain. juwi also has numerous references in the field of repowering.

A pioneering partnership

Since 2014, the juwi Group and MVV Energie AG have been developing a safe, efficient and climate-friendly energy system. Thanks to our partnership with one of Germany's largest energy suppliers, we are able to cover the entire energy value chain. Together, we offer plant operators attractive solutions, even after the subsidy **(post-EEG)** has ended.



juwi AG

Address **Energie-Allee 1
55286 Wörrstadt**
Phone **+49 (0)6732 9657-0**
Fax **+49 (0)6732 9657-7001**
E-Mail **info@juwi.de**
Web **www.juwi.com**
Category **Planning**
Profile **Planners & project developers**
Turnover **€ 775 million (juwi Group)**
Employees **ca. 850 (juwi Group)**
Founding year **1996**



01 | Competent, experienced and passionate: project development of juwi Group
02 | Windpark Lettweiler Höhe (Rhineland-Palatinate): Repowering-Project with public participation on heights in Southwest.

juwi Operations & Maintenance GmbH

Energy is here

We offer a complete service package comprising technical and commercial services as well as maintenance for wind energy and PV plants. For more than 20 years we have successfully ensured the highest returns for our customers. Moreover, we commercially manage more than 160 operating companies.

Technical Management

We offer support regarding the compliance with regulatory and insurance-related obligations. Moreover, we analyse faults and coordinate trouble shooting operations at your plant quickly and effectively. You receive an individual technical report for more transparency. Benefit from your personal and highly qualified client advisor who will ensure that your demands are met. Our AMS system (BG ETEM, OHSAS certified) ensures the occupational health and safety policy.

Maintenance and Repair

Build on our many years of experience, from recurring to condition-based inspections as well as servicing and site maintenance. We handle the maintenance of all components in line with manufacturer specifications and we offer sound recommendations for action. Our services include quick and effective maintenance for maximum yields.

Commercial Management

We take care of your entire financial management, from commercial bookkeeping and dunning to processing payment transactions. We handle communication with your business partners and third parties. Build on our experience in budget and liquidity management. Our services include support at shareholders' meetings, contract management and advice on legal and regulatory optimisation.

Remote Monitoring

Our 24/7 remote monitoring of plants guarantees trouble-free inspections, maintenance and repair work. This enables us to optimise the technical availability of your plant, laying the foundation for securing the best possible returns.

Are you interested in working with juwi? We would be pleased to provide you with an individual offer and answer any questions you may have!



01 | Control room in juwi headquarters Wörrstadt
02 | Plant capacity in Germany

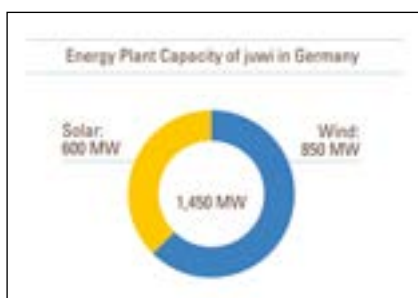

juwi Operations & Maintenance GmbH

Address **Energie-Allee 1
55286 Wörrstadt**

Phone **+49 (0)6732 9657-5090**

Fax **+49 6732 96 57-7001**

E-Mail **info@juwi-om.de**

Web **www.juwi-om.de**

Category **Operation & Service**

Profile **Technical & commercial operational management**

Turnover **approx. € 775 million (2016), juwi Group**

Employees **120 (only O&M)**

Founding year **1996**

The Liebherr Group

A Strong Partner for the Wind Industry

For 70 years, the Liebherr name has stood for excellent, benefit-oriented products and services. The Group is not only one of the world's leading manufacturers of construction machinery; it is also a major supplier in many other fields of engineering like the wind industry.



Liebherr is a powerful partner for the wind industry and offers convincing solutions for a wide range of requirements: On the one hand, components manufactured by Liebherr are installed directly into wind turbines. On the other hand, the company's mobile, crawler, offshore and tower cranes, for example, are used for erecting wind turbines and constructing wind farms.

Offering large diameter bearings, slewing drives, electric machines, frequency converters and hydraulic cylinders, Liebherr is the only manufacturer worldwide that provides not only single components, but also entire systems for electromechanical and hydraulic pitch and yaw adjustment in wind turbines. For rotor blade adjustment, Liebherr offers moment bearings in two main designs: as double-row tapered roller bearings or triple-row roller bearing slewing rings. The portfolio also includes compact full scale converter solutions for wind turbines with a capacity from 2 to 5 MW.

One of the major elements of cooperation with customers from all over the world is application-specific engineering to perfectly adapt each of the components. In the wind industry, Liebherr collaborates with nearly all leading turbine manufacturers and so far has equipped numerous wind turbines with its own components. The product portfolio comprises components for turbines from 800 kW up to solutions for multi-megawatt offshore turbines.

01 | From single components to final assembly, Liebherr offers the matching solution for different demands of the wind industry



03



04



02

With their innovative technology, high quality, profitability and longevity, mobile and crawler cranes from Liebherr own a leading position in the world market. For decades, they have also been proving their value in the construction of wind farms. As well as telescopic mobile cranes, Liebherr also provides lattice boom mobile cranes and crawler cranes to erect wind power systems, in a variety of performance classes, specifically matched to meet the needs of the wind power industry. The Group keeps pace with the development of larger and more efficient turbines as well as the increasing hub heights by offering cranes with optimized performance and new jib systems, reaching higher lifting capacities.

02 | Liebherr tower cranes of the type 1000 EC-B are specially designed to erect wind turbines and work extremely precise with a space-saving design

Cranes on narrow crawler travel gears especially developed for the construction of wind farms can move on the narrow tracks from one unit to the next in full setup condition, that is including jib and full ballast. This is especially economical, because machine and equipment have to be mounted only once.

For erecting wind turbines with a hub height of 110 m or more in low-wind areas, Liebherr also offers specially developed tower cranes with lifting capacities of up to 125 t. They are mounted on the wind turbine and are configured in a way that the necessary lifting height can be reached by guying the crane to the mast at one point only. Advantages are reduced space required by the crane, the ability to work despite high wind speeds and sensitive lifting of loads using Micromove.

Liebherr also offers efficient solutions for the erection of offshore wind turbines. Heavy duty cranes for offshore applications are able to lift up to 5,000 t and reach a lifting height of 180 m above deck.

03 | Heavy load offshore crane CAL 640001500 Litronic® during installation of rotor star
04 | Liebherr LTM 1750-9.1 mobile crane installs the rotor star at a hub height of 80 m

Thereby the Group's offshore portfolio meets challenging requirements, such as the provision of diesel or electrical drive units, explosion protected cranes and cranes for ambient temperatures between +40 °C and -50 °C. Liebherr cranes are not only used successfully for the construction of offshore wind turbines, but also on oil and gas platforms, for offshore construction, pipe-laying or subsea operations down to 3,600 m below sea level.

LIEBHERR

The Liebherr Group

Address	Hans Liebherr Str. 45 88400 Biberach an der Riss
Phone	+49 (0)7351 41-0
Fax	+49 (0)7351 41-265
E-Mail	info.lho@liebherr.com
Web	www.liebherr.com
Category	Transport & Logistics
Profile	Crane companies, crane hire, special transport & components
Turnover	€ 10,551 million (2018)
Employees	46,169 (2018)
Founding year	1949

M.O.S.S. Computer Grafik Systeme GmbH

Domain-specific planning application and GIS based optimization of wind farm planning. M.O.S.S. offers planning application services, as well as integration solutions and consulting services with respect to optimizing the processes of planning wind farms (WPPA)



01 | Planning of wind park with WebGIS and module management with Wind-PIA

Wind farm planning & IT infrastructure (Wind-PIA)

Wind farm planning processes do not run chronologically, but iteratively. Supposedly reliable results can change again and again during the planning process. For project developers it is therefore all the more important to work with a structured, standardized and coordinated planning process. Wind-PIA can make wind farm planning more efficient by means of standardized geodata and information exchange. Technical, structural and organizational obstacles in the planning process are identified and reduced; e.g. by reducing duplication, avoiding data conversions and projection changes, or local and redundant data storage. Working with Wind-PIA can make wind farm planning processes up to 20% more efficient.

WebService for buffering official building footprints for restriction area analysis

M.O.S.S. has acquired the full ALKIS database of building footprints including their attributes for all of Germany and prepared them as a password-protected web service. On this basis, wind farm planners are able to buffer settlement areas in the area under consideration in a differentiated manner. In doing so, wind farm planners can be guided by the specifications of the respective planning authorities and buffer each building type in a differentiated way, depending on whether it is located in an inner (agglomeration) or outer zone (rural region). Buffer results are made available for download as shapefiles, so that they can easily be merged with other basic data in a local GIS.

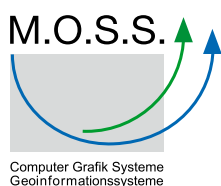

M.O.S.S. Computer Grafik Systeme GmbH

Address **Hohenbrunner Weg 13
82024 Taufkirchen**
Phone **+49 (0)89 66675-100**
Fax **+49 (0)89 66675-180**
E-Mail **info@moss.de**
Web **www.moss.de**
Category **Other services**
Profile **Software solutions**
Employees **65**
Founding year **1987**

N.T.E.S. GmbH

Maintenance • Repair • Inspection • Optimization

Wind turbine service since 2000. Independent maintenance and repair across Germany using the latest technology.



N.T.E.S. GmbH Windkraftservice is a service provider in the fields of REPAIR, INSPECTION, OPTIMIZATION, THERMOGRAPHY and MEASUREMENT primarily for Bonus” and “Siemens” wind turbines with capacities between 150kW and 2,3MW. Our highly skilled teams operate right across Germany. Flexibility and a fast response rate distinguish us.

Over 20 years experience in wind turbine service form an ideal basis for achieving optimum results both in case of repair work and prevention through servicing or inspection. In a survey of operators by the German Wind Energy Association (BWE) we achieved an overall rating of GOOD for the categories “regular service”, “unscheduled repair” and “extraordinary service”.

An overview of our services:

Maintenance

- Carrying out annual/biannual maintenance work
- Transformer maintenance
- Blade maintenance

Repairs

- 24-hour fault elimination service with remote data monitoring and maintenance
- Quick response time for repair work
- Large stock of replacement parts
- Inexpensive repairs thanks to our large stock of exchange parts
- Recommendation for optimisation

Inspections

- Blade inspection
- Blade reports
- Gearbox inspection
- Failure analysis

Recurring Audits

- DGUV V3
- Crane safety, climbing protection and conductor audits

Measurements

- Laser-supported generator alignment
- Earthing measurement
- Bearing condition check

Component repairs

- Electronic components
- Small yaw gearboxes

Development of new components

- Compensation systems
- Electrical switchgear
- Hydraulics

Component exchange

- Gearboxes
- Generators
- Main bearings



N.T.E.S. GmbH

Address **Handelshof 8
27432 Bremervörde**

Phone **+49 (0)4761 92612-0**
Fax **+49 (0)4761 92612-99**

E-Mail **wkas@ntes-service.de**

Web **www.ntes-service.de**

Category **Operation & Service**

Profile **Service, maintenance & repair**

Employees **30**

Founding year **2000**

Netze BW GmbH

wind power outlet

From engineering and approval planning to the construction of a turnkey transformer station, Netze BW division of services ensures wind farms feed into the 110kV grid efficiently.



Netze BW's wind power outlet is a standardized 110/30 or 110/20kV supply substation, which can be tailored precisely to the requirements of the renewable energy project in question by means of modular and performance-dependent components. It enables technically mature, cost-effective, direct supply to the high-voltage grid. The transformer station is constructed on a turn-key basis in just 10 months, including approval planning. Netze BW takes care of all the tasks involved, from planning and project development to construction and commissioning.

The services of Netze BW division of services at a glance:

- Planning, project development and construction of 110/30 or 110/20kV feeder substations or the entire wind farm infrastructure
- Planning, project development and construction of medium-voltage installations
- Construction of internal wind farm cabling
- Integration of the wind farm into the grid of the regional grid operator
- Management of all medium- and high-voltage plants with assumption of plant responsibility
- 24/7 on-call service and fault clearance for the wind turbines and wind farm infrastructure
- Certification of transformer station and wind farm

Ein Unternehmen der EnBW



Netze BW GmbH
Sparte Dienstleistungen

Address **Schelmenwasenstrasse 15**
70567 Stuttgart

Phone **+49 (0)711 289-46000**

Fax **+49 (0)711 289-46765**

E-Mail **dienstleistungen-hs@**
netze-bw.de

Web **www.netze-bw.de/**
dienstleistungen

Category **Planning**

Profile **Grids & grid connection**

Employees **about 3,700**

Founding year **2014**

01 – 04 | Transformer substations

NORD/LB

International presence with North German focus

With total assets of € 155 billion, NORD/LB Norddeutsche Landesbank is one of Germany's leading merchant banks.



01

Our ideas are extremely innovative – like the energy we invest in.

NORD/LB has been involved as a financier for projects in the renewable energy sector since the mid-1990s and has pioneered wind energy financing.

Having successfully advised and financed many on- and offshore wind as well as solar projects, we are one of the top arrangers for renewable energy project finance in the national and international markets. We support our customers in achieving their targets with our expertise, know-how and commitment.

Based on this, we are able to provide a thorough assessment of each projects' opportunities and risks and offer each of our customers' tailor-made solutions for their individual financing needs.

Our services range from optimising financing structures and funding sources (including multi-lateral and Export Cover structures) to providing advice and support during any potential project sale. Having financed one of the largest renewable energy portfolios provides an indispensable added value when consulting and structuring future projects.

We provide these services by international teams in Hanover, Oldenburg and London as well as specialists in New York and Singapore.

01 | Stunning view: This wind turbine has a hub height of 149 meters and rotorblades with a length of 57 meters.

02 | The NORD/LB building in Hanover

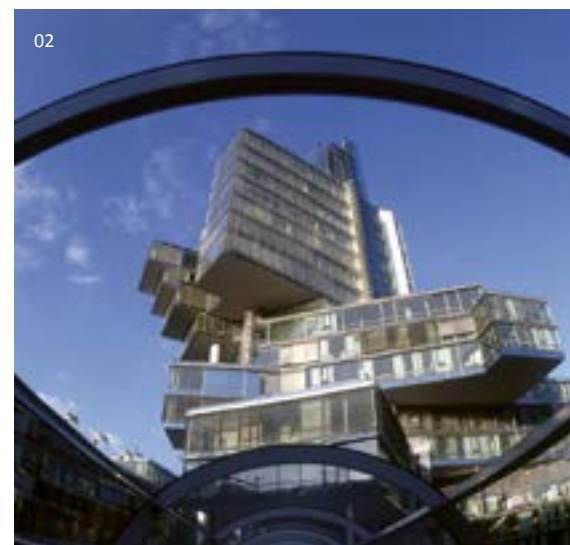

02

NORD/LB

NORD/LB

Address **Friedrichswall 10
30159 Hannover**

Phone **+49 (0)441 237-1667
G.Schmidt (nat. Proj.);
+49 (0)511 361-6696
H.Vogler (intern. Proj.)**

E-Mail **henning.vogler@nordlb.de ;
gerrit.schmidt@nordlb.de**

Web **www.nordlb.de**

Category **Finance & Law**

Profile **Banks, financial institutions &
financial service providers**

NOTUS energy

Power on your side

NOTUS energy has been initiating, implementing and operating wind power projects for nearly 20 years.



The Potsdam-based company has to date planned and built more than 560 wind turbines. NOTUS energy provides a complete range of services from planning to maintenance of wind farms from a single source.



NOTUS energy

Address	Parkstrasse 1 14469 Potsdam
Phone	+49 (0)331 62043-40
Fax	+49 (0)331 62043-44
E-Mail	windkraft@notus.de
Web	www.notus.de
Category	Planning
Profile	Planners & project developers
Employees	about 130
Founding year	2001

Services

Project Development

- Identification of suitable potential areas and acquisition of the required plots of land
- Investigation of wind conditions and economic profitability
- Establishing conformity with regional planning law and eligibility for planning permission
- Avifaunal mapping

Planning

- Approval procedure according to BISchmG
- Location selection, planning of infrastructure and grid connection
- Expert investigations and surveys of noise, shadow casting and turbulence
- Energy yield, wind measurement and wind survey assessments
- Evaluation of environmental compatibility and introduction of species protection measures

Construction management

- Construction planning and preparation of construction work
- Tendering and contracting to individual subcontractors
- Constructional supervision and technical support
- Health and safety coordination
- Certification according to DIN EN ISO 9001

Operational management

- Technical and commercial operational management of wind farms
- Optimal coordination of maintenance work and repair
- Billing of operating companies
- Direct marketing
- Certification according to DIN EN ISO 9001

Financing and marketing

- Standard project financing according to LMA standard
- Sale of turnkey wind power plants
- Regular participation in tenders

External services

- Undertaking third-party services in the fields of planning permission, construction management and operational management
- General contractor services for turnkey erection of wind farms

01 | NOTUS wind turbine

02 | Headquarters of NOTUS energy in Potsdam



PIONEXT GmbH

Wind energy with PIONEXT: shared knowledge for complete success.

PIONEXT stands for longstanding experience in the energy sector with rooting in the region of Rhineland-Palatinate. The company unites three successful energy companies: PFALZWERKE AKTIENGESELLSCHAFT, EWR AG und Mainzer Stadtwerke AG. These are operating in the field of regenerative energies since the beginning of the nineties.



Our DNA – who we are

We are your partner in planning, construction and operational management of wind energy plants. Our guarantee for you: Best of know-how, above average availability, highest efficiency and long-term security in all projects. We are bundling experience of three traditional companies. PIONEXT unites three successful energy companies from south western Germany and thus sets new standards in the field of renewable energies. We are leading specialists in the area of renewable energies.

Impression of constructing a wind power plant in Rüssingen



Project Development from Planning to Implementation

Successful project development depends on transparency at all times. Our project development experts provide project support from A to Z – from designing the wind farm layout and the conclusion of land contracts to the construction and commissioning of the wind turbines.



Technical Operations Management with Vision

Our optimized technical operations management provides you with a holistic services package that can be flexibly adapted to meet your requirements. In addition to the traditional services, our portfolio also includes medium voltage infrastructure management and IT security.

Repowering for Higher Energy Yields

Our professional repowering concepts will help you generate more power with fewer turbines by replacing the legacy plant with new, modern wind turbines, which are much more efficient and also have a positive impact on the appearance of the landscape. We are here to make sure that the entire region is ready for energy transition.



PIONEXT GmbH

Address **Gartenstraße 22
55232 Alzey**

Phone **+49 (0)6731 405-0**

E-Mail **info@pionext.de**

Web **www.pionext.de**

Category **Operation & Service**

Profile **Technical & commercial
operational management**

Founding year **2019**

PNE AG

Solutions for clean energy

Development, realisation, operation and management of wind farms – international, onshore and offshore.



Overview

Whether on land or at sea, domestically or internationally: PNE stands for comprehensive competence in the planning and operation of wind farms. Since 1990, the PNE Group has successfully realized more than 230 onshore wind farms worldwide with a total nominal output of more than 3,000 MW.



PNE AG

Address **Peter-Henlein-Strasse 2–4
27472 Cuxhaven**
 Phone **+49 (0)4721 718 06**
 Fax **+49 (0)4721 718 200**
 E-Mail **info@pne-ag.com**
 Web **www.pne-ag.com**
 Category **Planning**
 Profile **Planners & project developers**
 Employees **approx. 400**
 Founding year **1995**

Construction management

As a service provider, the PNE Group also takes over the construction management. With our decades of expertise, we guarantee the smooth planning and execution of your project. From the installation of the wind turbine with the assembly of the various individual parts to completion, everything is perfectly coordinated.

Wind farm management

After commissioning we usually stay in charge of the technical and commercial management of the wind farm for our customers. We make sure it is regularly serviced and maintained and that it runs as efficiently as possible.

01 | Altenbruch wind farm, Lower Saxony
 02 | Gode Wind offshore wind farm, North Sea
 03 | Headquarters of PNE AG, Cuxhaven



Renewal of wind farms

As a group committed to sustainability, PNE replaces older wind turbines with more modern and efficient systems. Modernization of wind farms can lead to a considerable increase in output.

Purchase of wind farms

The development of wind farm projects and repowering are associated with risks and uncertainties. Some developers or wind farm operators are therefore looking for a strong partner. Here, the PNE Group is ready for partnership-based solutions or the purchase of projects and wind farms, too.

Markets

Apart from the established markets for wind energy such as Germany, France or the USA, we will also focus on emerging markets in the future. These include: Latin America, the Middle and Far East as well as Africa. These are characterised by high energy demand and thus offer great sales potential.



psm Nature Power Service & Management GmbH & Co. KG

Manufacturer-independent full-service provider: We offer you every aspect of technical and commercial management, plus servicing for wind turbines and solar plants.



Your full-service provider – for full success.

At psm you have access to every service you require during the lifetime of your wind turbine or solar plant – from both a technical and a commercial perspective. As a manufacturer-independent company we always have both sides in mind. Because we know what makes sense from a technical perspective, we can always develop the most cost-effective solution for you. Profit from more than 20 years of experience as a service company for renewable energies.

We offer:

Wind Power

- Commercial management
- Technical management
- Maintenance and service
- Network technology

Photovoltaics

- Technical management
- Commercial management



Fully dedicated with a fair approach

The psm team – now around 120 strong – are genuinely enthusiastic about every project and give 100 percent, whether the task is replacing a gear unit or creating a profit forecast. What is particularly important to us? Open an honest communication with our customers: we say what we think. And we act when others are still talking.

Locally across Europe

The focus of our business is in Germany. We are represented here by an extensive network of locations and look after both wind turbines and solar plants. We do, however, also work throughout Europe.



psm Nature Power Service & Management GmbH & Co. KG

Address **Juelicher Strasse 10–12
41812 Erkelenz**

Phone **+49 (0)2431 9733-6**

Fax **+49 (0)2431 9733-777**

E-Mail **service@psm-service.com**

Web **www.psm-service.com**

Category **Operation & Service**

Profile **Service, maintenance & repair**

Turnover **€ 12 million**

Employees **120**

Founding year **1998**

R+V Versicherung AG

R+V offers comprehensive insurance cover for wind turbines.

From planning and installation through to the operational phase, wind turbines require comprehensive insurance cover. This is now available all under one roof with R+V's new wind insurance concept.



R+V adviser Jan Kehnapfel (left) is a competent contact for Mr. Petersen, an onshore wind farm operator



R+V Versicherung AG

Address **Raiffeisenplatz 1
65189 Wiesbaden**
 Phone **+49 (0)40 23606-5855**
 E-Mail **agrarpartner@ruv.de**
 Web **www.ruv.de/firmenkunden/
erneuerbare-energien/
windenergie**
 Category **Finance & Law**
 Profile **Insurance companies**
 Turnover **€ 16.9 billion**
 Employees **15,615**
 Founding year **1922**

R+V is part of the German cooperative banking group Volksbanken Raiffeisenbanken (VR), making it part of a strong alliance. What we offer our customers, in addition to the latest products and extensive knowledge, is our local presence. Across the 900 VR banks and their 10,000 branches, our customers find a named contact for all their insurance matters. You can be sure that we are always there for you.

First-hand knowledge all under one roof – KompetenzCenter AgrarPartner

As one of the largest insurers for renewable energy plants, R+V has over 30 years experience in this field. To strengthen our position in the rapidly growing renewables market, we have bundled our knowledge and expertise in the *KompetenzCenter AgrarPartner*. Our team of experts implements new product ideas

across all areas and continuously develops the existing product offer.

Our staff are always identifying the latest trends in the fields of wind power, solar energy and biogas in cooperation with leading companies and associations. Helping you make sustainable use of our solutions well into the future.

R+V insurance solutions for your wind turbines

Wind turbine operators are making an important contribution to the success of the energy transition. This way of generating power is especially climate-friendly and particularly lucrative – provided you are sufficiently well insured.

From planning and installation to the operational phase, R+V offers comprehensive cover all under one roof with its new insurance concept especially for wind energy.

Let us join forces at the early stages of your project so we can offer you the very best support and advice.



Ramboll

World leading wind consultancy

As a full-service provider, Ramboll supports wind projects of all kinds. We are part of one of the world's leading consulting companies and are able to combine global know-how with local expertise.

Since the development of the first Ramboll wind turbines in 1986, we have rapidly expanded our involvement in wind energy projects. Ramboll is now considered the world's leading consultancy in offshore wind energy – more than 65% of offshore wind turbines are based on foundations planned by Ramboll. In Onshore wind Ramboll has more than 20 years of project experience.

With our international, interdisciplinary and wind-energy-specific expertise, we are a full-bandwidth planner and consultant for wind energy projects. Ramboll offers comprehensive expert services for the various project phases, from feasibility studies, business plans and compatibility studies to wind measurements (LiDAR and masts), planning, design and execution.

Ramboll manages projects effectively and works with other experts in the various subprojects, according to customer needs. Not only do we offer one-stop-shop consulting with global competence centers, we also have a network of branch offices to serve our customers directly on site.

As a full-service provider for wind energy projects of all kinds, we support our customers along the entire value chain and have the resources necessary to be able to implement challenging wind energy projects.



01 | Offshore foundation

02 | LiDAR measurement at onshore wind turbine



Ramboll

Address **Chilehaus C – Burchardstraße 13
20097 Hamburg**
Phone **+49 (0)40 302020-132**
Fax **+49 (0)40 302020-199**
E-Mail **info@ramboll.de**
Web **www.ramboll.de**
Category **Planning**
Profile **Offshore and Onshore**
Turnover **€ 1.5 billion (worldwide)**
Employees **15,000 (worldwide)**
Founding year **1945**

Regenerative Energien Zernsee GmbH & Co. KG

The art of managing a wind farm

REZ can take over everything from the technical and commercial management right up to managing the entire business. And this includes site management.



“Managing” a wind farm sounds simple enough, but what if the situation is complicated? In the wind energy sector, things really are becoming more and more complicated. And this is a good reason to let someone else do the management. You have the free choice: REZ can take over everything from the technical and commercial management right up to managing the entire business. And this includes site management.

A wind farm is only as economical as you make it. And with the requirements becoming increasingly complex over the years, this is now truer than ever. That is why REZ places emphasis on intensive support, competent decisions and short communication paths.



REZ takes over either individual tasks or the entire management of the business – always perfectly tailored to the customer’s requirements. This can include technical and commercial operations management, site management with its own on-site service, direct marketing and repowering measures. The goal is always a strong performance combined with a high level of efficiency and transparency for the customer.

Getting the neighbours of wind farms on board

REZ has developed specific acceptance measures, so that local residents can benefit from the wind farms without having to take any economic risks. The key project involves providing a special electricity rate for the neighbours in which green electricity is offered at a favourable price.

On this basis, REZ currently manages 100 wind turbines with a total output of 250 megawatts. The availability of the REZ fleet will amount to around 99 percent in the medium term. In addition to wind farms, REZ also manages three substations.

The REZ quality management system is certified in accordance with ISO 9001:2015. REZ is also involved in the plant management advisory committee of the German Wind Energy Association (BWE).



Regenerative Energien Zernsee GmbH & Co. KG

Regenerative Energien Zernsee GmbH & Co. KG

Address **Bergstrasse 1
12169 Berlin**
Phone **+49 (0)30 224 459 830**
Fax **+49 (0)30 224 459 831**
E-Mail **zentrale@rez-windparks.de**
Web **www.rez-windparks.de**
Category **Operation & Service**
Profile **Technical & commercial
operational management**
Employees **16**
Founding year **2012**

RES Deutschland GmbH

A leading renewable energy company with 37 years of experience.

RES (Renewable Energy Systems) is the world's largest independent renewable energy company and has delivered more than 16 GW renewable energy projects across the globe. With 5 GW in operation and 1 GW Corporate PPA, RES enables its clients access to energy at the lowest cost.

RES is the world's largest independent renewable energy company active in onshore and offshore wind, solar, energy storage and transmission and distribution. At the forefront of the industry for 37 years, RES has delivered more than 16 GW of renewable energy projects across the globe and supports an operational asset portfolio exceeding 5 GW worldwide for a large client base. Understanding the unique needs of corporate clients, RES has secured 1 GW of power purchase agreements (PPAs) enabling access to energy at the lowest cost.

RES in Germany: Benefiting from a market leader

In Germany, RES Deutschland GmbH develops, finances and builds wind energy projects and energy storage systems as a part of the RES Group. In the onshore wind energy sector, RES manages the permitting and tender processes – from the beginning of site identification to the final operation of a windfarm. The expert teams take care of the swift project implementation - including operational management. With a storage portfolio of more than 300 MW, RES is one of the market leaders for industrial storage systems. RES builds turnkey energy storage systems for utilities, energy suppliers and industrial customers.

RES' proprietary RESolve control system, provides an array of grid support capabilities and maximizes the value proposition of the energy storage systems. RES' high-quality and reliable energy



storage systems are customized to meet the demand of any customer at a good price-performance-ratio.

Experience in markets without fixed feed-in tariffs, strong partnerships with manufacturers, international market presence and financial security make RES a strong partner for the Energy Transition.

- 01 | Prechtaler Schanze wind farm in Black Forest. RES has the know-how for planning and development process of wind farms in forest and under topographically challenging and complex permit requirements.
- 02 | 10 MW battery storage system in Bordesholm. Designed and built by RES, the battery storage system serves to provide frequency containment reserve to the grid. The system is capable of putting the grid area back into operation (black start capability) and enables the operation of an independent local grid (islanding capability)
- 03 | 20 MW battery storage system in Broxburn, Scotland.



RES Deutschland GmbH

Address	Unter den Linden 26–30 10117 Berlin
Phone	+49 (0)30 2205 6459-0
Fax	+49 (0)30 2205 6459-99
E-Mail	info.germany@res-group.com
Web	www.res-group.com
Category	Planning
Profile	Planners & project developers
Turnover	more than € 686 million
Employees	2,000
Founding year	1982

ROSCH Industrieservice GmbH

Your proficient, certified service provider for all-inclusive, professional wind power services

We offer our clients worldwide a reliable, professional service for flawless, efficient operation of complete wind turbines, both on- and offshore.



As a certified, quality service provider, we complete extremely challenging tasks which require expertise and many years' experience. We adopt a flexible approach to clients' individual requirements and take the latest technological developments as a starting point at all times. In doing so, we keep an eye on turbines for the long term to provide a timely response to malfunctions during operation and prevent breakdowns.

Our employees' safety is a priority for us, whether they are on the ground or high up in the nacelle. We therefore invest heavily in work safety and certify our employees as per DEKRA guidelines and SCC regulations. Thanks to this high qualification standard, we are able to undertake challenging work on safety- and test-relevant components and structures in industrial plant installations.

On- and offshore

Our versatile service offerings are tailored to your individual needs. In addition to professional installation of your turbine, services also include regular maintenance as per manufacturer specifications, servicing procedures, a repair service for turbine components, and development of special, customized solutions. In the offshore segment, we also manage to excel with a well-positioned concept, and are thus also able to satisfy special requirements offshore.

Since April 2017, we are part of ROBUR Industry Service Group GmbH. About 2,000 colleagues generated €150 million turnover in 2018, making ROBUR a Top 10 industry service provider in Germany. From planning and implementation, to operation and maintenance, to the relocation and decommissioning of industrial plants, we are expert partners of our clients and assist them in optimising the life cycle of their plants. Together we benefit from the Group's size, internationality, services, synergies and continuous investment in technological progress.



ROSCH
IHR WINDSERVICESPEZIALIST

ROSCH Industrieservice GmbH

Address **Bernardstr. 29**
49809 Lingen
Phone **+49 (0)591 800990-10**
Fax **+49 (0)591 800990-19**
E-Mail **info@rosch-industrieservice.de**
Web **www.rosch-industrieservice.de**
Category **Operation & Service**
Profile **Service, maintenance & repair**
Turnover **approx. € 11 million**
Employees **120**
Founding year **2008**



01 | OUR CHALLENGE WITHOUT LIMITS
02 | WIND SPECIALISTS WITH PASSION

Statkraft Markets GmbH

A secure future for your wind farm

As the market leader in direct marketing, Statkraft is a powerful partner who will support you in the market in the long term – even after the EEG subsidy has expired.

With a pioneering spirit, Statkraft is pushing ahead with the technical and economically viable integration of renewable energies. More than 120 years of experience as an operator of own power plants, in project development and in trading create the best conditions for the reliable marketing of renewable generation capacities. In addition to standard services such as production forecasts, selling power on the spot market and balancing, we are always at our customers' side in a spirit of partnership to facilitate their day-to-day energy activities – even beyond the EEG subsidy period.

Continued operations after 2020

The continued operation of wind farms beyond the expiry of the EEG subsidies is one of the key topics in the coming years – not only for operators and owners of wind farms. Statkraft already offers viable and long-term power purchase agreements that ensure the continued profitable operation of existing plants even after the subsidy has expired. We purchase electricity from our customers on fixed terms, thereby assuming commercial risks and enabling our customers to continue operating their plants.

Our team is a reliable partner with sound know-how. Statkraft makes all this possible not only in Germany, but also in Belgium, France, Great Britain, Ireland, the Netherlands, Poland, Scandinavia, Spain and Turkey.



01

Please do not hesitate to contact us if you have any questions about direct marketing or specifically about the continued operation of your plants after 2020. You can also meet us in person at wind industry days and trade fairs. Just have a look at the calendar on our website.

01 | The Statkraft direct marketing team: we will do it for you!

02 | Early planning for financial security and long-term operation.



02



Statkraft Markets GmbH

Address **Derendorfer Allee 2a
40476 Düsseldorf**
Phone **+49 (0)211 60 244-100**
Fax **+49 (0)211 60244-199**
E-Mail **direktvermarktung@statkraft.de**
Web **www.statkraftdirektvermarktung.de,
www.wind-win.de**
Category **Direct marketing**
Profile **Direct marketers**
Turnover **€ 26.2 billion**
Employees **449**
Founding year **1999**

Strothmann Machines & Handling GmbH

For innovative flow assembly lines 4.0 and high efficient movements of heavy loads
 Our RoundTrack® system has been in use for a wide variety of applications for more than 30 years and offers increases in efficiency in the areas of production and logistics by up to 30%.



- 01 | Flow assembly for rotor blades in painting booth
- 02 | Flow assembly for generators on the RoundTrack® system
- 03 | RoundTrack® profile
- 04 | AGV for fully automated assembly line for pipes for offshore wind turbines



Strothmann Machines & Handling GmbH

Adress **Altenkamp 11
33758 Schloss Holte-Stukenbrock**
 Phone **+49 (0)5207 / 9122-100**
 Fax **+49 (0)5207 / 9122-196**
 E-Mail **info@strothmann.com**
 Web **www.strothmann.com**
 Category **Transport & Logistics**
 Employees **130**
 Founding year **1976**

Since the company was founded in 1976, the name STROTHMANN stands for innovations in the field of transport and handling technology. With great expertise in customer specific and special mechanical engineering, STROTHMANN is a reliable partner with an international sales and service network.

The business areas:

- RoundTrack® systems
- PressRoomAutomation
- Handling Systems

In the highly competitive wind power industry, we have been helping our customers for years with efficiency increasing systems from the areas of Handling Systems (e.g. fully automated stacking of stator laminations) and RoundTrack® systems (e.g. flow production of large generators or transport of rotor blades through the spray booth).

There is a suitable solution for every customer application. With our experience of more than 1,000 RoundTrack® systems on the market, we support our customers in optimizing their transport or assembly tasks.



Advantages of the RoundTrack®:

- Installation on floor level
- Crossable with all vehicles
- High precision
- 5 tons can be moved by one person
- Increase effectiveness
- Low energy consumption in powered systems
- Low maintenance

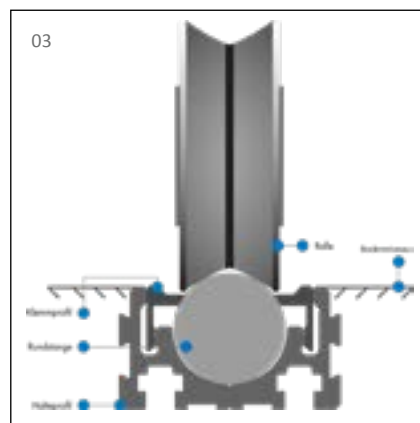

TÜV NORD EnSys GmbH & Co. KG

Full-Service Provider for the Wind Industry

TÜV NORD certifies wind turbines to all international standards and regulations, evaluates specific site conditions and supports operation of wind turbines over their entire lifecycle.



With more than 13,000 employees and experts in nearly all technical disciplines, TÜV NORD Group is one of the world's largest technical service providers. We owe our leading market position to our technical competence and a wide range of services in the field of consulting, testing and certification in our business units of Mobility, Industry Services and International. We operate in over 70 countries worldwide.

Within the field of wind energy TÜV NORD offers services in certification, site assessment and inspection of wind turbines (WTG) and projects. TÜV NORD is one of the leading accredited certification bodies for wind turbines certifying on- and offshore WTG according to all major guidelines such as IEC, IECRE, DNVGL, EN, GL, the Danish approval scheme, TAPS and BSH.

Type certification begins with the design assessment of loads, safety concept and all components of the WTG. Prototype tests then verify the assumptions made during design assessment and measure the power curve. On major components such as gearboxes and rotor blades, separate prototype tests are performed.



The third mandatory part of certification is the evaluation of manufacturing with respect to the quality system and the implementation of the design requirements during production. Major components can also be certified individually. Besides the well known type certification for manufacturers and project certification for project developers, all services for wind energy projects can also be offered as a one-stop shop. The entire range of project-related assessment services including life time extension is available to wind farm planners, operators and providers of finance.



TÜV NORD EnSys GmbH & Co. KG

Address **Grosse Bahnstr. 31
22525 Hamburg**
Phone **+49 (0)40 8557-0**
E-Mail **windenergy@tuev-nord.de**
Web **www.tuev-nord.de**
Category **Experts**
Profile **Wind resource evaluators**

UKA – Umweltgerechte Kraftanlagen GmbH & Co. KG

Leading onshore developer

UKA has been planning, building and managing wind farms and the associated infrastructure since 1999. With around 50 wind farms connected to the grid and a project pipeline of more than two gigawatts, the Group is one of the leading German wind farm developers. In addition, UKA has opened up new business areas and is also carrying out solar energy projects.

01



Complete solutions for decentralised energy generation

As a full-service supplier UKA provides all processes up to handover of the energy farm ready for operation.

The sister company UKA Projektträger GmbH & Co. KG based in Lohmen is responsible for carrying out all building projects of the UKA Group. Its large purchasing volume means that UKA Projektträger can work cost-efficiently and also offer its services to external customers – a win-win situation for all involved.

In this way external projects are supported through to approval-compliant implementation: from road and foundation construction through grid connection, turnkey construction and commissioning to following up all official requirements and acceptances in accordance with the Federal Immission Control Act.

As experts for wind energy in forest areas, UKA has already commissioned several wind energy farms in commercial forests. The group also successfully implements repowering projects.



02

The subsidiary UKB Umweltgerechte Kraftanlagen Betriebsführung GmbH looks after commissioning of the energy farms to ensure decades of optimal technical and economic performance of the plants.

The UKA Group currently employs around 500 staff at its sites in Meissen, Cottbus, Rostock, Erfurt, Oldenburg, Bielefeld, Hanover, Lohmen and Grebenstein and in the USA.



- 01 | Wind farm Gieboldehausen – project planning with needs-oriented night identification
- 02 | UKA sites in Germany
- 03 | Plan – Construct – Supervise: complete service services from one source
- 04 | Range of services provided by UKA group



Der Energieparkentwickler

UKA - Umweltgerechte Kraftanlagen GmbH & Co. KG

Adress **Dr.-Eberle-Platz 1
01662 Meißen**

Phone **+49 (0)3521 72 80 60**

E-Mail **zentrale@uka-gruppe.de**

Web **www.uka-gruppe.de**

Category **Planning**

Profile **Planners & project developers**

Employees **500**

Founding year **1999**

VERBUND

VERBUND is one of the largest producers of hydro electricity in Europe and the German-speaking world

Today, the major challenge is the integration of renewables. We offer flexible product marketing, efficient storage and pool solutions, and impressive service concepts.



Individual solutions for existing and new turbines

Whether wind, water, photovoltaics or biomass, direct marketing in accordance with the EEG has been compulsory for new generating plants of 100 kilowatts or more since 2016. VERBUND Trading & Sales Deutschland, a trading subsidiary of the largest electricity concern in Austria, carries out direct marketing of its green electricity for turbine operators throughout Germany. As an experienced player on the electricity market, VERBUND has the required expertise to master the challenges in this dynamic environment in a cooperative way.

Our offer:

- Optimum green electricity marketing on intraday, spot and futures markets
- Longterm marketing concepts for your over 20 year old wind plants
- Regional verification as an additional source of income for turbine operators and municipal utilities
- Many years' experience of producing forecasts
- Networking in virtual VERBUND power plant
- Registration and re-registration of turbines
- Participation in the electricity balancing market
- Individual contract periods

Benefits:

- Low prices thanks to optimum electricity marketing and flexible power stations
- Extra yield compared to EEG feed-in tariff
- Downtime remuneration if feed-in performance is reduced
- Financial security thanks to excellent financial standing
- Personal contacts in Munich and Düsseldorf

VERBUND – Europe's green battery

With its flexible 8,200 megawatt power plant, VERBUND is the largest producer of hydro-electricity in Austria and Bavaria. This is ideally supplemented by VERBUND's own wind farms and those marketed for third parties.

Flexibility products

The generation portfolio consisting of hydro and wind power is the basis for flexibility products designed specifically for the requirements of the market.

Verbund

Power for the Future

VERBUND

Address **Sonnenstrasse 17
80331 Munich**
Phone **+49 (0)89 890 56 21933**
Fax **+49 (0)89 890 56 21950**
E-Mail **direktvermarktung@verbund.de**
Web **www.verbund.com**
Category **Direct marketing**
Profile **Direct marketers**
Turnover **€ 2.94 billion (Q1/2019,
VERBUND AG)**
Employees **about 3,150**
Founding year **1947**

01 | VERBUND-Windpark Bruck in Leitha, Vienna



Volkswind GmbH

Production of clean and renewable onshore wind energy

Volkswind has been one of the leading wind energy producers in Europe since 1993. Its core business comprises the planning, projection, construction and operation of wind turbines.

Being a pioneer of the German wind energy business with over 1000 MW realized wind energy Volkswind is nowadays one of the leading European developers and operators of onshore wind farms. This comprises a diversified portfolio with regards to geographies as well as clients.

After the take-over by the Swiss utility Axpo in 2015, Volkswind is even stronger positioned in the market for the further expansion and diversification of its project portfolio, also with view to regulatory changes in the energy market.

The Axpo Group produces, trades and distributes energy reliably in Switzerland and in over 30 countries throughout Europe. Around 4500 employees combine the expertise from 100 years of climate-friendly power production with innovative strength for a sustainable energy future.



Axpo is a global leader in energy trading and the development of customized energy solutions for its clients. Axpo's energy know-how and its market and industry experience ensure a strong strategic partnership in the wind energy sector.

Besides a further expansion of the business activities in the core markets Germany and France this partnership comprises also the expansion of the operational management and asset management.



Volkswind GmbH

Address **Gustav-Weisskopf-Str. 3
27777 Ganderkesee**
Phone **+49 (0)4222 94138-0**
Fax **+49 (0)4222 94138-99**
E-Mail **info@volkswind.de**
Web **www.volkswind.de**
Category **Planning**
Profile **Planners & project developers**
Employees **83**
Founding year **1993**

VSB Group

Project development | Planning | Construction | Operational Management | Maintenance

Trust in more than 20 years of experience and more than 910 megawatt installed capacity. We provide profitable solutions throughout the entire value chain of wind energy projects.



Wind is our passion and project development is our core competence. We accompany every step from securing land through approval planning to the implementation of wind farms, for which we are also your contact when it comes to technical and commercial management as well as maintenance and repairs. Choose between the whole package with VSB as a general contractor or a tailored set of individual services. To prepare for the electricity market of tomorrow, we also focus on storage solutions for matching demand and supply of renewable electricity.

Empathy and Acceptance

The energy transition can only succeed if all stakeholders act in concert. Therefore, our projects are put into practice in close cooperation with residents, municipalities, and local representatives. This results in highly individual solutions regarding turbine locations, windfarm layouts and compensation measures. Above that, scheduled receipts and financial rewards for citizens add to making renewable energies a long-term benefit for local communities.

Tested Quality

VSB has received certification according to the DIN EN ISO 9001:2015 in Germany and France. What does this mean for our everyday business? It ensures that responsibilities are clearly assigned, processes are bindingly defined and knowledge is documented in a systematic manner. Hence, you can put your trust in legal compliance, reliable yield projections and a strict monitoring of project costs.

In Your Vicinity

Climate action does not stop at regional borders. Consequently, our experts work internationally on implementing a sustainable energy supply. With our headquarters in Dresden and three regional German offices as well as subsidiaries in France, Finland, Ireland, Italy, Poland, Romania and Tunisia we are always in reach when accompanying your project from the beginning to the end.



VSB Group

Address **Schweizer Strasse 3a
01069 Dresden**
 Phone **+49 (0)351 21183-400**
 Fax **+49 (0)351 21183-44**
 E-Mail **info@vsb.energy**
 Web **www.vsb.energy**
 Category **Planning**
 Profile **Planners & project developers**
 Employees **more than 300**
 Founding year **1996**

- 01 | Regional Value Added: Wölkisch wind farm (Saxony, 20.5 MW)
- 02 | Wipperdorf wind farm (Thuringia, 14.4 MW)



Wind-Tech Services Rechlin GmbH

We live for wind energy.

Wind-Tech Services Rechlin GmbH is a service provider headquartered in Germany. We are a young, dynamic company and focus on the demanding technical and economic requirements and specifications in the field of wind power.

Our comprehensive expertise and experienced specialists who have acquired their know-how from leading manufacturers, among other things, ensure that we can provide the proper support for your wind turbines.

Our wind turbine services:

Thanks to our experienced specialists and Europe-wide locations, we can offer a wide range of services at a high level. Our service range extends from the preparation of expert reports to maintenance and repairs to tower cleaning and testing of safety-relevant equipment. A further focus is on rotor blade servicing and component replacement.

Wind-Tech Services GmbH – Special Unit:

We set up the Rostock-based Wind-Tech Services GmbH – Special Unit” to implement special tasks. This specialist department draws upon its collective expertise, a sound understanding of safety and experience to carry out all work and tests on the rotor blade and the towers.

Europe-wide network of branch offices:

We provide active support to our clients in Scandinavia, Great Britain, the Benelux countries, Italy, Turkey, Greece, France and Germany. Our objective is to find the optimal solution for you, with the expert support of our more than 130 highly committed and qualified employees worldwide.

Simply get in touch so that we can discuss your options.



- Servicing & maintenance
- Accident and emergency service
- Repairs - Repowering
- Component replacement
- Inspections & site visits
- Rotor blade & tower service
- Foundation refurbishment
- Wind farm maintenance
- Continuing education & training



01

- 01 | Blade inspection via rope access equipment
02 | Large component replacement
03 | Large component replacement



02



03



Wind-Tech Services Rechlin GmbH

Address **Müritzstrasse 11
17248 Rechlin**

Phone **+49 (0)39823 270 334**
Fax **+49 (0)39823 270 336**

E-Mail **info@wind-tech-services.de**
Web **www.wind-tech-services.de**

Category **Operation & Service**
Profile **Service, maintenance & repair**
Employees **130**
Founding year **2010**

Windwärts Energie GmbH

An MVV Group Company

With 25 years' experience, Windwärts is one of the pioneers of the wind power sector and, as an MVV Group company, is currently making a major contribution to the transformation of the energy system.

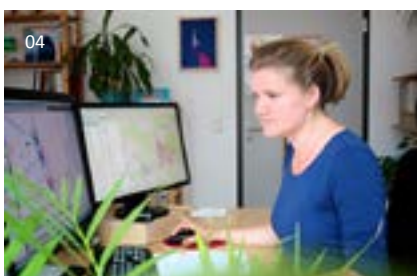

Expertise and a Passion for the Energy Transition

We at Windwärts understand our trade from the search for suitable sites to planning, funding and wind farm construction to the operational management throughout the operational life of the facilities even after the cessation of funding provided under the German Renewable Energy Sources Act (EEG). The level of competency of our circa 85 employees in all these areas is as much a central aspect of Windwärts' work as diligence and attention to detail. This is vital for estimating risks, clearing the hurdles involved in complex approval processes and the successful management and completion of invitation to tender processes, whereby our staff always remain focused on a specific objective, which feeds their motivation and commitment: the will to bring about the energy transition in concrete terms and on site.

Experienced in Onshore Wind Power

Our business segments include project development, implementation and operational management for onshore wind power and photovoltaic facilities. In addition, we provide construction and planning services, project repowering and collaborative services for community energy companies and other actors. We focus on the states of Lower Saxony, Schleswig-Holstein and the Ostwestfalen-Lippe region. Windwärts has connected 175 wind turbines with a combined output of 372 MW to the grid. Our operational management segment is in charge of facilities throughout Germany with a combined output of around 600 MW and ensures that the best possible yields are achieved.

Finishing Strong

Land owners, operators, communities and investors all benefit from this experience and motivation as do municipal utilities and the energy suppliers for whom Windwärts plans and builds wind turbines. Windwärts has been part of the MVV Group, one of Germany's leading power companies, since 2014.



Windwärts Energie GmbH

Address **Hanomaghof 1
30449 Hanover**
Phone **+49 (0)511 123573-0**
Fax **+49 (0)511 123573-190**
E-Mail **info@windwaerts.de**
Web **www.windwaerts.de**
Category **Planning**
Profile **Planners & project developers**
Employees **85**
Founding year **1994 / 2014**

- 01 | Continued operation or repowering: We are your experts also post-EEG
- 02 | Looking Ahead: shaping tomorrow's energy with Windwärts
- 03 | Around the clock: we have control of technology
- 04 | From A to Z: We are leading your project along the path to success

WKN GmbH

Renewable energies for today and tomorrow

WKN GmbH is one of the leading project developers in Germany, Europe and South Africa. And that has been the case for nearly thirty years.

WKN's goal is to further expand existing markets and develop attractive new markets.

WKN GmbH has been planning, developing, financing and building high-calibre wind energy projects since 1990. As one of the pioneers of the German wind energy scene, the company from Husum has been a leading developer for decades as well as having a presence in many international markets. By the mid of 2019, WKN had already built 1,565 megawatts of installed capacity in its 117 projects.

The WKN team is made up of a group of renowned wind energy experts who embrace every project as a new challenge and always strive, together with on-site project partners and stakeholders, to achieve the best possible solution. Their well-developed spirit of pioneering thinking was critical in bringing this project developer to the international markets early on.



WKN has been building and implementing major projects in the USA, Italy, Poland, France and Sweden since 2007. At the same time, the company from Husum is targeting new potential growth markets. WKN consistently focuses on long-term strategies and cooperation with local partners. Wind farms planned by WKN feature in the portfolios of well-known national and international corporations, institutional investors and utilities, and WKN then continues to successfully operate them.

Their services include site evaluation, development, planning, financing, turnkey construction, operation, and commercial and technical management of wind farms. In the future WKN will be adding more services to the existing product portfolio to position itself even more strongly in the markets, focussing in particular on financial services, wind planning services, construction, operational management, repowering and energy supply.

WKN GmbH is a wholly-owned subsidiary of PNE AG, Cuxhaven.



WKN GmbH

Adress	Otto-Hahn-Strasse 12–16 25813 Husum
Phone	+49 (0)4841 8944-100
Fax	+49 (0)4841 8944-225
E-Mail	info@wkn-group.com
Web	www.wkn-group.com
Category	Planning
Profile	Planners & project developers
Employees	about 150
Founding year	1990

01 | Local heroes for international challenges

02 | Wind farm Kropp-Tetenhusen, Germany

Wölfel Wind Systems GmbH

Structural Intelligence – we are experts for analyzing the measurement data of our Condition Monitoring Systems (CMS) for rotor blade, tower and foundation. To optimize wind turbines, we successfully develop and supply products for sound and vibration reduction.

Ice detection or reduction of tonalities, structural health monitoring (SHM) of rotor blades, towers or foundations or rotor blade inspections – our products and services focus on engineering in the field of structural mechanics and on the dynamics of your individual wind turbine (WT).



In signal analysis, we combine our findings from Third Party Inspection and recurrent inspection with the measuring data from the WT. In the past decades, Wölfel has built up and extended a unique core competence in this field. We extract the really relevant technical information from the flood of data. We provide information about structural damage on the blade, the tower or the foundation, about fatigue loads and the related lifetime consumption of your WT. We measure sound emissions and immissions and our experienced rotor blade inspectors assist you in all matters related to fibre composites.

The experience gained in research and service projects is taken into account and incorporated in the development of specific products.

The systems IDD.Blade® (for ice detection), SHM.Blade® (for condition monitoring of rotor blades) – both certified by DNV GL – and the active damper system ADD.Sound® (for the reduction of the tonal components in airborne noise) are impressive examples for the development of application-oriented solutions. Our damping system TMD.Tower reduces tower vibrations and thus increases the lifetime of your WT.

Our latest technological innovation is SHM.Tower® – a system for load monitoring and life cycle prognosis of your WT. It is easy to retrofit and energy self-sufficient and thus quickly made its way to international markets.

Wölfel Wind Systems – we transform measurement data into knowledge. With this knowledge you are on the safe side and have economic success!



Wölfel Wind Systems GmbH

Address **Max-Planck-Str. 15
97204 Höchberg**
Phone **+49 (0)931 49708-0**
Fax **+49 (0)931 49708-150**
E-Mail **info@woelfel.de**
Web **www.woelfel.de**
Category **Experts**
Profile **Technical consultants**
Founding year **1971**



wpd windmanager GmbH & Co. KG

Innovative. Experienced. Flexible. Reliable. Leading the Field in Wind Farm Management. We know what we're doing when it comes to operational management: over 20 years' experience. 370 staff members. 355 wind farms. 1,965 wind turbines. 4,053 MW total power output. We will manage your wind farm 24 hours per day, 7 days per week.

Since 1998, wpd windmanager has been providing all services required for the technical operational management and commercial business management of wind farms and solar parks. We are continually expanding our service portfolio to provide our customers with bespoke support services for their wind farms. Our portfolio of onshore wind turbines is growing steadily – both nationally and internationally. We are, therefore, very familiar with the challenges posed by various markets.

Technical Management

At the core of our wind farm management service is our 24/7 control room, where all of the facilities we manage are monitored around the clock, which enables us to minimise response times and loss of revenue. Among other things, our technical operational management team is responsible for operational monitoring, documentation and the management of contracts and warranty agreements. Our specialists are deployed to tackle special technical challenges relating to rotor blades, foundations and measuring technology.



Our on-site field service teams carry out site inspections at the facilities, accompany expert assessors and check maintenance and repair operations to ensure the smooth and optimal operation of the wind farms.

Commercial Management

We also have an extensive knowledge in all matters relating to taxation, legislation, and accountancy. In conjunction with central partners, our information management system rapidly provides our customers with information tailored to their specific requirements. We can also monitor deadlines and produce annual reports in this context.

Additional Services

We also offer wind farm operators numerous additional services, including, for example, bespoke solutions for burglary protection and our proprietary foundation system.



**wpd windmanager
GmbH & Co. KG**

Address **Stephanitorsbollwerk 3
(Haus LUV)
28217 Bremen**

Phone **+49 (0)421 897660-0**

Fax **+49 (0)421 897660-99**

E-Mail **windmanager@wpd.de**

Web **www.windmanager.de**

Category **Operation & Service**

Profile **Technical & commercial
operational management**

Turnover **€ 12 million**

Employees **370**

Founding year **1998**



Photo: Steffi Loos

PUBLISHER:

German Wind Energy Association

The German Wind Energy Association is the voice of the German wind energy sector. It publishes “Wind Industry in Germany”, brings together companies in its various committees, and uses its events to pass on technical knowledge to experts and newcomers alike.



The expert committees at the German Wind Energy Association (BWE)

Advisory boards – Forums – Working groups

At the BWE, operators, manufacturers, suppliers and service providers are organised into expert committees such as advisory boards, working groups and forums.



At the advisory board meetings, companies in the wind energy sector meet to discuss and resolve current issues and to develop long-term strategies concerning the most important issues in the industry.

Within their specialist areas, they therefore function as an important platform for exchange. The work carried out by these expert leads to position papers and statements; the standards developed then act as a guideline for the entire wind industry. The advisory boards are represented on the federal executive board of the BWE by four representatives, giving them a strong say in the association's policies.

Advisory board of operational managers

The advisory board of operational managers deals with all commercial and technical aspects related to wind turbine operation. Its members are also active in other associations to work towards guidelines.

Citizen's wind energy advisory board

The citizen's wind energy advisory board brings together operators of citizen's wind farms. Concerned with implementing the energy transition through citizen's and community-owned energy projects, it represents the interests of citizen's wind farm operators within the BWE.

Communication advisory board

Communication experts from the wind energy sector come together here to discuss how to communicate wind energy topics to the public in press and PR work. Member companies jointly plan campaigns, brochures and social media activities.

Expert advisory board

The expert advisory board discusses and develops policies and procedural guidelines for the technical examination of wind energy systems.

Finance advisory board

The finance advisory board is open to all banks and financing companies with activities in the wind energy industry. It acts as a forum for the exchange of ideas between different companies, such as the financial impacts of relevant legislation.

Investor's advisory board

The investor's advisory board is concerned with the quality of investment opportunities in wind farms. It analyses annual financial statements and collects important information on the financial situation and profitability of numerous wind farm projects.



Legal advisory board

The legal advisory board comprises over 100 lawyers and in-house legal counsels who together discuss current legal questions relating to wind energy. This involves the exchange of valuable information on current court cases. The latest legal proceedings are also discussed by the legal advisory board. Written opinions are submitted jointly with the BWE's Expert Committees Division.

Manufacturer and supplier board

Through the companies represented in it, the committee brings together representatives of the German wind industry in the BWE. The Board works closely with the BWE on industry-related topics.

Operators' advisory board

On the six operator forums at the BWE, members exchange knowledge about each manufacturers' wind turbines. Operators of both individual and multiple wind turbines are organised in such forums. The speakers of the forums meet regularly to discuss their experiences in the operators' advisory board.

Planning advisory board

The planning advisory board is an important platform for the exchange of information by planning companies. Expert presentations accompany the discussion of major topics such as local and national planning laws, the future shape of the EEG, and European energy policy. Together with the Expert Committees Division, members support the positioning of the BWE regarding planning questions.

Scientific advisory board

As a forum for BWE members active in research and science, the scientific advisory board deepens current scientific discourses and establishes future research needs.

Wind consultant advisory board

The focus of the wind consultant advisory board is on improving onshore wind forecasts in Germany. Constant exchange of experiences and regular presentations on the topic are a foundation of its work, which particularly results in the definition of minimum standards for expert reports.

Working groups are established at short notice to deal with current issues and problems. They are organised across different boards, are able to act quickly, and can also hire external experts if necessary. Representatives from around 131 member companies are currently involved in working groups for networks, radar, obstruction lighting, nature conservation and wind energy, foundations, energy policy and continued operation.

All 2,200 operator companies who are members of the BWE are organised in the operators' advisory board via operator forums. Of the 1,100 manufacturers, suppliers and service providers who are members, 220 companies are members of the boards of the BWE. Each board meets between 2 and 4 times a year. The work of the boards is supported by the Expert Committees Division of the BWE both thematically and organisationally. Close collaboration results in information and background papers for BWE members, positions on bills, or BWE positions. For further information on the work of the boards and working groups and to view the lists of members, go to: www.wind-energie.de/verband/fachgremien.



German Wind Energy Association

The expert committees at the German Wind Energy Association (BWE)

Address **Neustädtische Kirchstraße 6
10117 Berlin**
Phone **+49 (0)30 212341-210**
Fax **+49 (0)30 212341-410**
E-Mail **info@wind-energie.de**
Web **www.wind-energie.de**
Profile **Associations**
Category **Organisations &
public institutions**
Founding year **1996**

German Wind Energy Association (BWE) – Events & Corporate Publishing

Knowledge about wind – networking – qualification



BWE events

With around 5,000 participants across nearly 100 events per year the BWE is the market leader in education in the wind energy sector. A wide variety of formats enable experts and leading figures from the wind energy sector to stay abreast of current developments and expand their networks.

The “Wind Industry Days” (Windbranchentage) have become an established platform for dialogue and a forum for exchange with political circles in various federal states. With up to 800 participants they are the largest BWE events. Every year they host numerous politicians representing all levels.

At the conferences, practice days, information days and seminars selected experts pass on their practical knowledge, enabling participants to learn about the latest developments in their respective fields. Frequently, new business leads are also established there.

Digital formats such as webinars make it possible to respond to issues arising in the sector at short notice and to transfer knowledge without much effort.

An overview of all events can be found here: www.bwe-seminare.de

The German Wind Energy Association – a strong partner

With around 20,000 members it is the world’s largest association for renewable energies. The BWE has been campaigning for a sustainable and efficient expansion of wind energy in Germany for many years.

With its ambitious expansion targets, the wind energy sector is the main driver of the energy transition. Together with its members, the BWE is fully committed to continuing the success story of German wind energy and to ensuring that the vision of “100 percent electricity from renewable energy” in Germany becomes a reality soon.

The German Wind Energy Association – knowledge & networking

In addition to political work, knowledge & networking is a central impetus for the German Wind Energy Association. BWE has accompanied the economic and technical progress of the industry for many years with its education events and publications from which everyone, novice and expert alike, can obtain the latest facts about the growing wind industry.



02



Yearbook



Industry directory

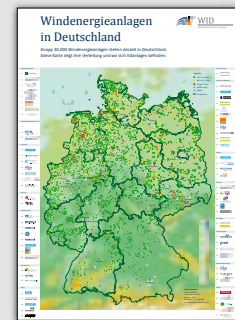

Wind map

BWE publications

In addition to events, the German Wind Energy Association is also packing its knowledge into countless specialist publications. For example, for the last 30 years it has published the wind energy handbook which offers an excellent overview of facts, figures and data and the development of both the market and technology in Germany.

Furthermore, the BWE also publishes specialist in-depth publications devoted to topics surrounding technical operational management, service or project planning. The knowledge gained through them can be utilised in important company decisions, thereby promoting the continued sustainable growth of the industry. An overview of all BWE publications is available here: www.wind-energie.de/shop

The industry directory

The present directory of the German wind industry is the flagship of the sector where companies can present their services and products to a broad audience. The comprehensive address section makes it a real reference book for anyone looking for partners in the wind industry. All companies and current news are also readily accessible online at www.windindustrie-in-deutschland.de



German Wind Energy Association

German Wind Energy Association (BWE) – Events & Corporate Publishing

Address **Neustädtische Kirchstraße 6
10117 Berlin**

Phone **+49 (0)30 20164-222**

Fax **+49 (0)30 212341-362**

E-Mail **service@wind-energie.de**

Web **www.bwe-seminare.de**

Profile **Education & training**

Category **Education & training**

Founding year **1996**

01 + 02 | Photo: Steffi Loos

new energy

magazine for climate action and renewable energy

new energy is our bimonthly sister publication for English speakers. Between 6,000 and 10,000 copies of the magazine are distributed throughout Europe and the world, mainly in Brussels.

The magazine **new energy** has information for decision-makers, researchers, industry representatives or anyone with an interest in political, economic or technical aspects of the energy transition. Five times a year, our team provides thorough and balanced reporting on current trends, explores political and economic issues and examines the latest technological developments.

Experts from ministers to battery researchers explain their take on things in interviews. Comprehensive country reports analyse developments all over the globe, while portraits and background reports offer in-depth coverage of the most exciting and urgent aspects of the energy transition. In short: thought-provoking magazine journalism on one of the most important topics of our time.



Further information on www.newenergy.info

new energy
magazine for climate action and renewable energy

new energy
Address **Neustädtische Kirchstraße 6
10117 Berlin**
Phone **+49 (0)30 212341-141**
Fax **+49 (0)30 212341-340**
E-Mail **service@newenergy.info**
Web **www.newenergy.info**
Profile **Media & Communication**
Category **Other services**
Employees **10**
Founding year **1998**



Editor-in-Chief Jörg-Rainer Zimmermann

Subscribe to the switch to renewables!



Subscribe online at www.newenergy.info/subscriptions



www.andsee.de

new energy
magazine for climate action and renewable energy



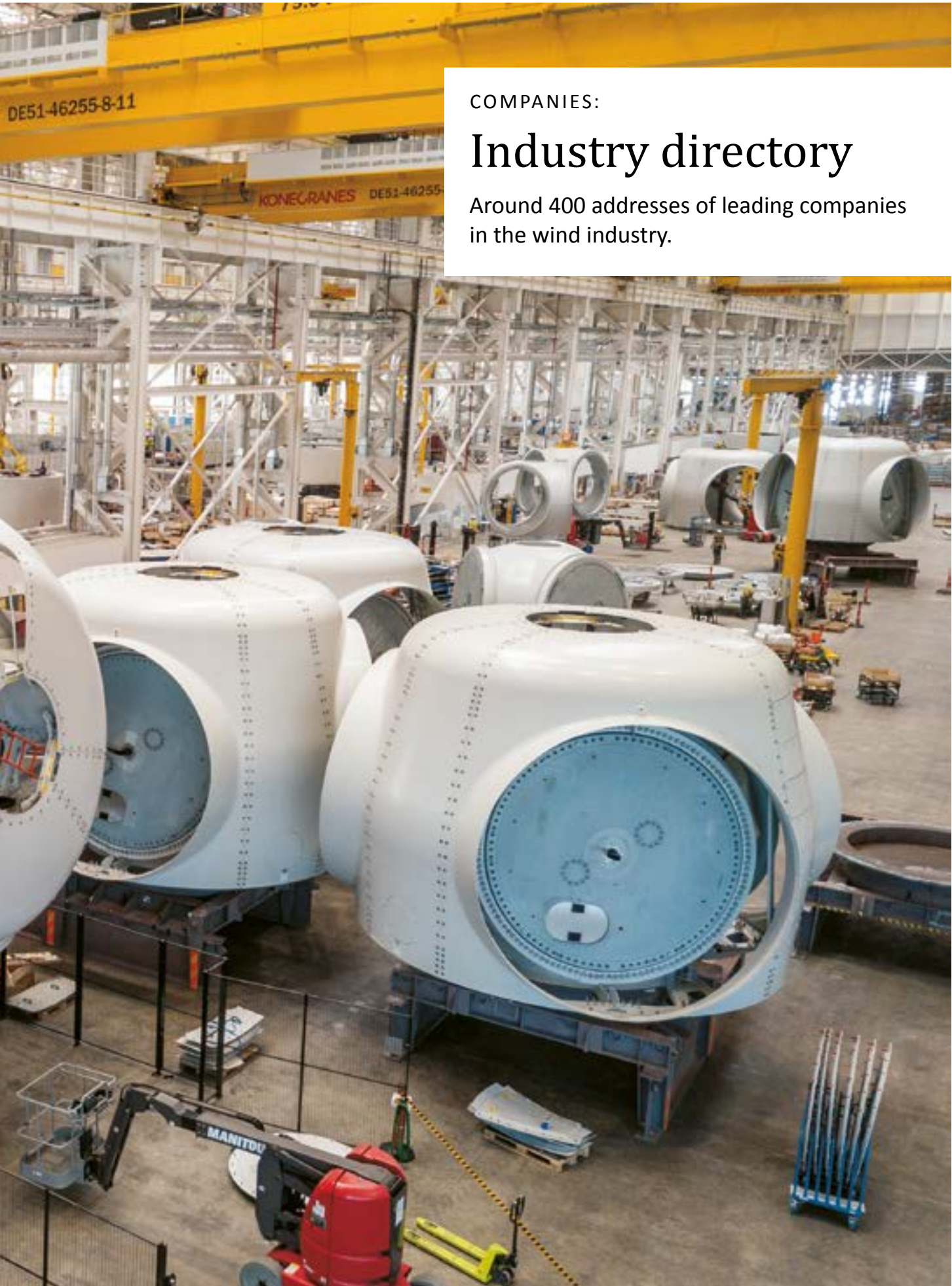

COMPANIES:

Industry directory

Around 400 addresses of leading companies in the wind industry.

Direct marketing

Direct marketers



BayWa r.e. Clean Energy Sourcing GmbH

Katharinenstrasse 6, 04109 Leipzig

Tel.: +49 (0)341 308606-00

Fax: +49 (0)341 308606-06

E-Mail: dv@baywa-re.com

www.baywa-re.de

EEG direct marketing, virtual power plant to ensure remote controllability, marketing concepts for plants without subsidies, WindGuide 20+, self-supply from green-electricity plants.



Centrica Energy Trading GmbH

Gustav-Mahler-Platz 1, 20354 Hamburg

Tel.: +49 (0)40 228676950

Fax: +49 (0)40 228676958

E-Mail: energytrading@centrica.com

www.centrica.com

Centrica Energy Trading is a leading European provider of energy management services. Our main competencies on the German market are Direct Marketing and power purchase agreements for renewable production assets.



EnBW Energie Baden-Württemberg AG

Durlacher Allee 93, 76131 Karlsruhe

Tel.: +49 (0)721 6315382

E-Mail: direktvermarktung@enbw.com,

vermarktung20plus@enbw.com

www.enbw.com,

www.enbw.com/direktvermarktung

Optimal marketing, individual concepts for continued operation even without EEG funding (PPA). As one of the leading direct marketers in Germany with a strong credit rating, we are a reliable partner.



EWE TRADING GmbH

Am Weser-Terminal 1, 28217 Bremen

Tel.: +49 (0)421 69625-307

Fax: +49 (0)421 69625-309

E-Mail: Direktvermarktung@ewe.de

www.ewe-trading.de

EWE TRADING GmbH is a renowned direct marketer for renewable energies in Germany. We support operators of wind farms and solar parks across Germany in marketing their electricity.



VERBUND

Sonnenstrasse 17, 80331 Munich

Tel.: +49 (0)89 8905621933

Fax: +49 (0)89 8905621950

E-Mail: direktvermarktung@verbund.de

www.verbund.com

VERBUND is one of the largest producers of hydro electricity in Europe. In Germany, VERBUND is your partner for reliable electricity procurement, energy efficiency and direct marketing.



GEWI AG

An der Börse 4, 30159 Hannover

Tel.: +49 (0)511 51949-200

E-Mail: info@gewi-ag.de

www.gewi-ag.de

INNOVATIVE, ECOLOGICAL, TOGETHER. GEWI AG
YOUR PARTNER FOR DIRECT MARKETING

Forecasting services providers



energy & meteo systems GmbH

Marie-Curie-Str. 1, 26129 Oldenburg

Tel.: +49 (0)441 36116-470

Fax: +49 (0)441 36116-479

E-Mail: mail@energymeteo.com

www.energymeteo.com

Broad range of services for integration of renewable energy: wind and solar power forecasts worldwide, virtual power plant for remote control, managing and marketing of decentralized production units.



in.power GmbH

An der Fahrt 5, 55124 Mainz

Tel.: +49 (0)6131 69657-0

Fax: +49 (0)6131 69657-29

E-Mail: kontakt@inpower.de

www.inpower.de

The services of the in.power group: Whether it is direct marketing, meter operation, remote control, continued operation or regional green electricity products for end users – we are your partner!



Statkraft Markets GmbH

Derendorfer Allee 2a, 40476 Düsseldorf

Tel.: +49 (0)211 60244-100

Fax: +49 (0)211 60244-199

E-Mail: direktvermarktung@statkraft.de

www.statkraftdirektvermarktung.de,

www.wind-win.de

Statkraft is an important player in energy trading and a reliable partner who, with a pioneering spirit, is driving forward the technical and economically sensible integration of renewable energies.

Education & training

Education & training



blade care Academy

Neuenfeld 41, 17291 Schoenefeld

Tel.: +49 (0)163 8860079

E-Mail: post@bladecare.de

www.bladecare-academy.com

blade care Academy is certified by the DNV-GL as a specialised training facility for rotor blade and wind turbine technology.





Safety training

Deutsche Windtechnik Training Center Viöl

Mühlengrund 3, 25884 Viöl
Tel.: +49 (0)4843 20448-162
Fax: +49 (0)4843 20448-149
E-Mail: j.krippner@deutsche-windtechnik.com
www.deutsche-windtechnik.com

The Training Center Viöl offers a transfer of knowledge in original turbines from leading manufacturers. Well-equipped training rooms offer optimal conditions for theoretical knowledge transfer.



EMD Deutschland GbR
www.emd.dk

EMD Deutschland GbR

Breitscheidstrasse 6, 34119 Kassel
Tel.: +49 (0)561 31059-60
Fax: +49 (0)561 31059-69
E-Mail: sales-de@emd.dk
www.emd.dk

EMD Deutschland, exclusive sales agency of the Danish software manufacturer EMD International A/S, arranges courses for the software products windPRO and energyPRO on a regular basis.



KRAFTWERKSSCHULE e. V. (KWS)

Deilbachtal 199, 45257 Essen
Tel.: +49 (0)201 8489-0
Fax: +49 (0)201 8489-102
E-Mail: info@kraftwerksschule.de
international.kraftwerksschule.de

KWS PowerTech Training Center. KWS is the German power industry's leading training center and offers tailored training measures for all employees from the renewable energies sector, particularly from the wind energy part.



REETEC GmbH

Konsul-Smidt-Str. 71, 28217 Bremen
Tel.: +49 (0)421 39987-0
Fax: +49 (0)421 39987-11
E-Mail: info@reetec.eu
www.reetec.eu

More than 350 standardised safety and technical trainings as well as current training courses on occupational health and safety for the onshore and offshore sectors.



Deutsche WindGuard Offshore GmbH

An der Weinkaje 4, 26931 Elsfleth
Tel.: +49 (0)4404 9875-100
E-Mail: buchung.training@windguard.de
www.windguard-training.de

Certified Safety Trainings for the onshore and offshore wind industry. GWO basic safety trainings and refresher, Helicopter Underwater Escape Training as well as trainings according to DGUV.



Deutsche Windtechnik Training Center Bremen

Hüttenstrasse 20a, 28237 Bremen
Tel.: +49 (0)421 62677-0
Fax: +49 (0)421 62677-11
E-Mail: m.stueven@deutsche-windtechnik.com
www.deutsche-windtechnik.com

The Training Center provides certified safety courses in accordance with GWO and DGUV. All relevant safety aspects are rehearsed in a realistic environment with experienced trainers.



OFFTEC Base GmbH & Co. KG

Lecker Strasse 7, 25917 Enge-Sande
Tel.: +49 (0)4662 89127-0
Fax: +49 (0)4662 89127-88
E-Mail: info@offtec.de
www.offtec.de

Accredited provider GWO Basic Safety Training: Working at Heights, First Aid, Fire Awareness (according to German DGUV), Manual Handling, Sea Survival, HUET, Offshore First Aid, technical training.



SHE Solution Bergmann GmbH & Co. KG

Im Sundernkamp 2, 32130 Enger
Tel.: +49 (0)5224 9393850
Fax: +49 (0)5224 9393852
E-Mail: info@she-solution.de
www.she-solution.de

SHE Solution is your certified training provider according to GWO and DGUV standard. Trainings are conducted realistically by experienced trainers and can be given inhouse upon request or directly at wind power plant.

Energy services



BayWa r.e. Clean Energy Sourcing GmbH

Katharinenstrasse 6, 04109 Leipzig
Tel.: +49 (0)341 308606-00
Fax: +49 (0)341 308606-06
E-Mail: dv@baywa-re.com
www.baywa-re.de

EEG direct marketing, virtual power plant to ensure remote controllability, marketing concepts for plants without subsidies, WindGuide 20+, self-supply from green-electricity plants.



Landstrom GmbH & Co. KG

Watenstedter Str. 11, 38384 Gevensleben
Tel.: +49 (0)5354 26600-66
Fax: +49 (0)5354 26600-19
E-Mail: info@landstrom-landwind.de
www.landstrom-landwind.de

Climate-neutral electricity and gas from a single source, direct marketing, service and consultancy across the entire spectrum of renewable energies in co-operation with Landwind at competitive prices



PIONEXT GmbH

Gartenstraße 22, 55232 Alzey
Tel.: +49 (0)6731 405-0
E-Mail: info@pionext.de
www.pionext.de

PIONEXT GmbH has successfully completed over 500 wind turbines and photovoltaic systems and is always there for you as an expert partner.



Manufacturer and supplier advisory board



Expert consulting advisory board



Investors' advisory board



Expert consulting advisory board



Scientific advisory board



Operators' advisory board

Experts

Certification



FGH – Forschungsgemeinschaft für elektrische Anlagen und Stromwirtschaft e.V

Besselstr. 20–22, 68219 Mannheim

Tel.: +49 (0)621 976807-50

Fax: +49 (0)621 976807-70

E-Mail: info@fgh-ma.de

www.fgh-ma.de

For a secure grid connection

Your experienced partner for a reliable grid integration: accredited measuring & certification, on-site inspections and electrical engineering service.

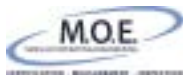

M.O.E. GmbH

Fraunhoferstr. 3, 25524 Itzehoe

Tel.: +49 (0)4821 6453-100

Fax: +49 (0)4821 6453-140

E-Mail: info@moe-service.com

www.moe-service.com

M.O.E. is an accredited test laboratory and certification and inspection body, which offers services to ensure the long-term and conformen operation of wind turbines.



TÜV SÜD Industrie Service GmbH

Westendstr. 199, 80686 Munich

Tel.: +49 (0)89 5791-1232

Fax: +49 (0)89 5791-2022

E-Mail: windenergy@tuev-sued.de

www.tuev-sued.de/windenergy

Type certification, project certification, offshore certification, site assessment, operating time extension



UL DEWI-OCC

Offshore and Certification Centre GmbH

Am Seedeich 9, 27472 Cuxhaven

Tel.: +49 (0)4721 5088-0

Fax: +49 (0)4721 5088-43

E-Mail: admin.dewi-occ@ul.com

ul.com/renewables

Type certification of on- and offshore WT/components, project certification of offshore wind farms as well as grid code compliance, type approval, examinations, periodic inspections, risk/damage analyses.



WIND-certification GmbH

Reuterstr. 10, 18211 Bargeshagen

Tel.: +49 (0)38203 7483-10

Fax: +49 (0)38203 7483-11

E-Mail: info@wind-certification.de

www.wind-certification.de

Certification body: plant certificates,

unit certificates, component certificates



WindGuard Certification

Oldenburger Str. 65, 26316 Varel

Tel.: +49 (0)4451 9515-247

E-Mail: info@windguard-certification.de

www.windguard-certification.com

Certification body and test laboratory for testing & certification of electrical grid compliance (wind, solar, CHP), certification of WTG & continued operation, SDA & project certification.

BWT Bavnick Wind-Technik GmbH

Bentheimer Str. 20, 48465 Schüttorf

Tel.: +49 (0)5923 71555

Fax: +49 (0)5923 71557

E-Mail: h.bavnick@bwt-wind.de

www.bwt-wind.de

Evaluaton before commissioning, evaluaton towards the end of the guarantee, expert evaluaton of gears (endoscopic), regular checks, vibraton analyses (CMS / on- or offline), expert damage assessment.



DEKRA Automobil GmbH

Handwerkstr. 15, 70565 Stuttgart

Tel.: +49 (0)800 3333333

E-Mail: kundencenter@dekra.com

www.dekra.de

Audits, Assessments, measurements of wind energy plants on-/offshore, access platforms, pressure tanks, electrical engineering, continued operation – throughout Germany, neutral and independent partner.



Deutsche WindGuard

Oldenburger Str. 65, 26316 Varel

Tel.: +49 (0)4451 9515-0

Fax: +49 (0)4451 9515-29

E-Mail: tp@windguard.de

www.windguard.com

Accredited inspection body (DIN EN ISO/IEC 17020), safety & condition oriented inspections, end-of-warranty & commissioning inspections, video endoscopy, manufacturing & installation supervision.

Technical consultants



Ackermann & Knorr Ingenieurbüro GmbH

Am Harthauer Bahnhof 11, 09125 Chemnitz

Tel.: +49 (0)371 8531-74

Fax: +49 (0)371 8531-64

E-Mail: info@ackermann-knorr.de

www.ackermann-knorr.de

Independent experts for wind turbines.

Expert for occupational health and safety.



Energie profile Ingenieurbüro Glocker

Kotzenbruehl 4C, 87700 Memmingen

Tel.: +49 (0)8331 983-686

Fax: +49 (0)8331 983-665

E-Mail: Stephan.Glocker@energieprofile.de

www.energieprofile.de

Publicly appointed and authorized expert for turbines, member of WINDexperts GmbH.

Commissioning inspectons – periodic inspectons

– video endoscopy gears – vibraton measurement

– warranty inspections.



Wind assesment advisory board



Financing advisory board



Communication advisory board



Legal advisory board



Planning advisory board

**enveco GmbH**

Grevener Strasse 61c, 48149 Muenster
Tel.: +49 (0)251 315810
Fax: +49 (0)251 3833516
E-Mail: mail@enveco.de
www.enveco.de

All expertise required for the approval of your wind turbine, advice to districts and municipality, site potential analysis, urban land use planning, repowering concept, ecol. construction supervision

**HD-Technic GmbH**

Venesch 6a, 49477 Ibbenbüren
Tel.: +49 (0)5451 3591
Fax: +49 (0)5451 745540
E-Mail: info@hd-technic.com
www.hd-technic.com

HD-Technic has been a competent and trusted partner in the energy sector for more than 25 years. As an engineering and expert office, we support and advise in all phases of a projec.

**Jetstream Bosse Ing.-Büro für Windenergienutzung**

Hoepfnerstr. 34, 12101 Berlin
Tel.: +49 (0)30 789915-25
Fax: +49 (0)30 789915-26
E-Mail: info@jetstream-bosse.de
www.jetstream-bosse.de

Expert opinions, inspections, remote data monitoring, technical advice, alignment inspection, video endoscopy, operational management WEC and wind farms, due diligence, valuation.

**expert office Dipl.-Ing. Harald Eden**

An der Beverbäke 4b, 26123 Oldenburg
Tel.: +49 (0)441 21823-10, +49 (0)170 5513877
Fax: +49 (0)441 21823-11
E-Mail: sv-eden@t-online.de
www.sv-eden.de

Publicly appt/sworn expert for causes of fire and electrical systems of energy technology. VdS electrotechnical expert. Investigation of fire damage, electrotechnical causes, fire prevention analysis.

**ie-Renewables | Ingenieurbüro für Erneuerbare Energien**

Zuckerberg 9, 55276 Oppenheim
Tel.: +49 (0)6133 491498-0
Fax: +49 (0)6133 491498-3
E-Mail: info@ie-renewables.de
www.ie-renewables.de

Professional and comprehensive consultancy services: regional as well as international project development, Due Diligence, contract negotiation/ tendering, Repowering, Asset Management & more.

**KÖTTER Consulting Engineers GmbH & Co. KG**

Bonifatiusstr. 400, 48432 Rheine
Tel.: +49 (0)5971 9710-31
Fax: +49 (0)5971 9710-43
E-Mail: oliver.bunk@koetter-consulting.com
www.koetter-consulting.com

Consulting, sound & shadow casting prognosis, immission and emission measurements for all WTG types and manufacturers. Expert opinions for approval procedure, construction acoustics, training courses.

**FAKON Wind GmbH**

Zum Nordkai 16, 26725 Emden
Tel.: +49 (0)4921 8013308
Fax: +49 (0)4921 8737249
E-Mail: info@fakonwind.de
www.fakonwind.de

Interim Management, Project Management, Expert Reports, Due Diligence, Examination of Insurance Claims, SCADA, Grid Connection, Construction Supervision, Expert Services, Advice on Operation & Maintenance.

**Ingenieurbüro Andresen**

Uthlander Str. 34, 25813 Husum
Tel.: +49 (0)4841 7206-72
Fax: +49 (0)4841 7206-73
E-Mail: info@ibandresen.de
www.ibandresen.de

Publicly appointed and authorized expert for wind turbines, commissioning, warranty certificates, techn. & periodic inspections, CMS, video endoscopy.

**TÜV Rheinland Industrie Service GmbH**

Am Grauen Stein, 51105 Köln
Tel.: +49 (0)221 8064536
Fax: +49 (0)221 8061886
E-Mail: wind@de.tuv.com
www.tuv.com

TÜV Rheinland provides technical inspection, testing and certification services for our onshore and offshore wind energy clients. Learn more about our services, get in contact with us!

**GfM Gesellschaft für Maschinendiagnose mbH**

Köpenicker Strasse 325, 12555 Berlin
Tel.: +49 (0)30 65762565
Fax: +49 (0)30 65762564
E-Mail: mailbox@maschinendiagnose.de
www.maschinendiagnose.de

Vibration Diagnosis | Inspection | Videoendoscopy | Blade Bearing Diagnosis | Foundation Monitoring | Torque Analysis

**Jadewind GmbH & Co. KG**

Lange Str. 6, 26316 Varel
Tel.: +49 (0)4451 862228
Fax: +49 (0)4451 862282
E-Mail: info@jadewind.de
www.jadewind.de

Publicly appointed and sworn expert, Appraisal of WEC at – end of warranty – commissioning – periodic and condition based inspection – damage claim – court expert.

**TÜV SÜD Industrie Service GmbH**

Westendstr. 199, 80686 Munich
Tel.: +49 (0)89 5791-1232
Fax: +49 (0)89 5791-2022
E-Mail: windenergy@tuev-sued.de
www.tuev-sued.de/windenergy

Periodic inspections, acceptance inspections, site assessment, operating life extension, type certification, project certification, offshore certification





WIND-consult GmbH

Reuterstrasse 9, 18211 Admannshagen-Bargeshagen
 Tel.: +49 (0)38203 507-25
 Fax: +49 (0)38203 507-23
 E-Mail: company@wind-consult.de
www.wind-consult.de
 Inspections prior to Commissioning, for Acceptance and prior to Warranty expiry, Periodical Inspection, Extended Lifetime 20+, Checking Blade Angle, Main Grid Protection Test, Harmonics Measurement



windtest grevenbroich gmbh

Frimmersdorfer Str. 73a, 41517 Grevenbroich
 Tel.: +49 (0)2181 22780
 Fax: +49 (0)2181 227811
 E-Mail: info@windtest-nrw.de
www.windtest-nrw.de
 Accredited services such as measurements of electrical characteristics, power performance/curve, loads, acoustics, site evaluations (site quality, yield report, shadow impact), LIDAR verification



anemos-jacob GmbH

Oldershausener Hauptstrasse 22, 21436 Oldershausen
 Tel.: +49 (0)4133 210696
 Fax: +49 (0)4133 210695
 E-Mail: wind@anemos-jacob.com
www.anemos-jacob.com
 Internationally recognised independent consultant for wind resource assessments, wind measurements, due diligence, site suitability, analysis and optimisation of wind farm and wind turbine performance.



Wind-Tech Services Rechlin GmbH Special Unit

Charles-Darwin-Ring 4, 18059 Rostock
 Tel.: +49 (0)381 666585-63
 Fax: +49 (0)381 666585-65
 E-Mail: specialunit@wind-tech-services.de
www.wind-tech-services.de
 Extensive support for tower and blades
 Repair / Inspection / Training



Wölfel Wind Systems GmbH

Max-Planck-Str. 15, 97204 Höchberg
 Tel.: +49 (0)931 49708-0
 Fax: +49 (0)931 49708-150
 E-Mail: info@woelfel.de
www.woelfel.de
 SHM, CMS, ice detection, vibration measurement, vibration reduction, inspection and testing of rotor blades, mastering tonalities, noise measurement, monitoring, life time calculation



Deutsche WindGuard

Oldenburger Str. 65, 26316 Varel
 Tel.: +49 (0)4451 9515-0
 Fax: +49 (0)4451 9515-29
 E-Mail: info@windguard.de
www.windguard.com
 Wind measurements, wind resource & energy yield assessment, site suitability studies, noise/shadow propagation, noise measurement, power curve measurement, load measurement, ice throw risk assessment



windexperts Prüfgesellschaft mbH

Überseetor 14, 28217 Bremen
 Tel.: +49 (0)421 3963123
 Fax: +49 (0)421 3963183
 E-Mail: info@windexperts.de
www.windexperts.de
 Network of experts for wind turbines – Appraisals: commissioning, periodical, condition oriented and end of warranty inspections, extended operation, CMS, video endoscopy, damage appraisals.

Wind resource evaluators



AL-PRO GmbH & Co. KG

Dorfstrasse 100, 26532 Großheide
 Tel.: +49 (0)4936 69860
 E-Mail: info@al-pro.de
www.al-pro.de
 AL-PRO is accredited for: LIDAR wind measurements (with own devices), wind data analyses (bankable), turbulence determination, shadow- and noise calculations and weather and yield forecasts.



EWS Consulting GmbH

Katztal 37, 5222 Munderfing
 Tel.: +43 (0)7744 20141
 Fax: +43 (0)7744 20141-41
 E-Mail: office@ews-consulting.at
www.ews-consulting.com
 Accred. services: mast & remote sensing measurement, wind potential & energy yield forecast, site classification, power curve & performance assessment, Verification of RSD, noise emission measurement



Windräder Ingenieurbüro Cerbe & Dr. Rische

Manfred-von-Ardenne-Ring 5, 01099 Dresden
 Tel.: +49 (0)351 811269-0
 Fax: +49 (0)351 8589345-77
 E-Mail: info@windraeder-service.de
www.windraeder-serice.de
 Technical inspection of wind turbines – focus on rotor blades.



anemos Gesellschaft fuer Umweltmeteorologie mbH

Boehmsholzer Weg 3, 21391 Reppenstedt
 Tel.: +49 (0)4131 8308-0
 Fax: +49 (0)4131 8308-199
 E-Mail: kontakt@anemos.de
www.anemos.de
 anemos Gesellschaft für Umweltmeteorologie is an accredited independent consulting company for wind energy meteorology and your first-choice-partner for wind and energy studies in Germany and abroad.

GEO-NET Umweltconsulting GmbH

Grosse Pfahlstrasse 5a, 30161 Hanover
 Tel.: +49 (0)511 38872-00
 Fax: +49 (0)511 38872-01
 E-Mail: info@geo-net.de
www.geo-net.de
 Reports of: Bankable wind and energy yields, Wind potential studies, Met masts and LiDAR measurements / verification, Micrositing / Optimisation of wind farm layout, Tech.Due Diligence, Performance analysis, Turbulence expertise





Ingenieurbüro Kuntzsch GmbH

Moritzburger Weg 67, 01109 Dresden
Tel.: +49 (0)351 88507-1
Fax: +49 (0)351 88507-409
E-Mail: gutachten@ib-kuntzsch.de
www.windgutachten.de

DIN ISO 17025 accredited for wind measurements, energy yield assessments, site quality; noise & shadow-flicker assessment, visualizations, WINDebit operational data evaluation, wind energy yield index



Power of Nature – Windenergie

Aulendorf 40, 48727 Billerbeck
Tel.: +49 (0)2543 93046-74
Fax: +49 (0)2543 93046-73
E-Mail: joerg.fuertges@powernature.de
www.powernature.de

Wind/yield forecasts, noise immission prognoses, shadow flicker analyses, visual impact assessments, visualisation of wind projects, turbulence assessment, evaluation/analysis of wind data.



TÜV NORD EnSys GmbH & Co. KG

Grosse Bahnstr. 31, 22525 Hamburg
Tel.: +49 (0)40 8557-0
E-Mail: windenergy@tuev-nord.de
www.tuev-nord.de

TÜV NORD certifies wind turbines to all international standards and regulations, evaluates specific site conditions and supports operation of wind turbines over their entire lifecycle.



Meteorologisches Beratungsbüro, Dr. S. Theunert

Kolberger Strasse 21, 54516 Wittlich
Tel.: +49 (0)6571 5912
Fax: +49 (0)6571 28849
E-Mail: theunert@metconsult-online.de
www.metconsult-online.de

Energy yield assessment, expertise on yield loss during planning and operation, wind potential analysis, noise and shadow flicker assessment, evaluation of measuring data.



Ramboll

Breitscheidstrasse 6, 34119 Kassel
Tel.: +49 (0) 561 288573-10
E-Mail: info@ramboll.de
www.ramboll.de

As an accredited DAKKS laboratory (DIN EN ISO / IEC 17025: 2005), Ramboll works in accordance with national and international guidelines / standards of the wind industry in order to produce state-of-the-art wind analyses.



TÜV SÜD Industrie Service GmbH

Ludwig-Eckert-Str. 8, 93049 Regensburg
Tel.: +49 (0)941 460212-0
Fax: +49 (0)941 460212-29
E-Mail: windenergy@tuev-sued.de
www.tuev-sued.de/windenergy

Site assessment. Wind measurement – Mast – LIDAR – SODAR. Ice-throw risk analysis. Due diligence. Power performance test. Mechanical load measurement. Approval inspections. Periodic inspections.



Pavana GmbH

Otto-Hahn-Strasse 12–16, 25813 Husum
Tel.: +49 (0)4841 8944-227
E-Mail: info@pavana-wind.com
www.pavana-wind.com
Pavana GmbH is an accredited company (acc. DIN EN ISO/IEC 17025) for energy yield reports, noise studies, flicker studies, wind measurement campaigns and LiDAR verification.



reko Windenergie-Analysen

Sander-Bruch-Strasse 10, 33106 Paderborn
Tel.: +49 (0)5254 9528129
Fax: +49 (0)5254 952729
E-Mail: r.korfmacher@rekowind.de
www.rekowind.de

Noise immission prognoses, shadow flicker analyses, wind/yield forecasts for sites, visualisation, visual inspection by drone.



UL International GmbH

Ebertstr. 96, 26382 Wilhelmshaven
Tel.: +49 (0)4421 4808-0
Fax: +49 (0)4421 4808-843
E-Mail: dewi@dewi.de
www.dewi.de

UL Renewables is a trusted independent advisory, testing, inspection and certification body for wind, solar and energy storage with more than 500 technical experts worldwide.



PLANKon Ing.-Büro für Windenergieprojekte

Blumenstrasse 26, 26121 Oldenburg
Tel.: +49 (0)441 39034-0
Fax: +49 (0)441 39034-22
E-Mail: mail@plankon.de
www.plankon.de

Expert opinions/consultancy for wind, noise, shadow; wind measurements, planning, accredited test laboratory acc. to DIN ISO 17025.



Tractebel Engineering GmbH

Friedberger Str. 173, 61118 Bad Vilbel
Tel.: +49 (0)6101 55-1445
Fax: +49 (0)6101 55-1826
E-Mail: info-de@tractebel.engie.com
www.tractebel-engie.com/en/solutions/energy#renewables

Tractebel Engineering GmbH offers world-wide planning and consulting services for onshore and offshore wind farm projects as well as wind expertises according to ISO 17025.



WIND-consult GmbH

Reuterstrasse 9, 18211 Admannshagen-Bargeshagen
Tel.: +49 (0)38203 507-25
Fax: +49 (0)38203 507-23
E-Mail: company@wind-consult.de
www.wind-consult.de

DAKKS Accreditation / FGW / BWE, Measure & Expert's Reports for Planning & Permission of WT – Wind Measurements (Cup / LIDAR), Wind & Energy Yield, Turbulence & Stability, Extreme Wind, Site Quality



Manufacturer and supplier advisory board



Expert consulting advisory board



Investors' advisory board



Expert consulting advisory board



Scientific advisory board



Operators' advisory board

Finance & law

Banks, financial institutions & financial service providers



DAL Deutsche Anlagen-Leasing GmbH & Co. KG

Emy-Roeder-Strasse 2, 55129 Mainz
Tel.: +49 (0)6131 804-2201
E-Mail: info@dal.de
www.dal.de

DAL is part of the German Savings Banks Finance Group and supports investments in the wind power sector with tailor-made financing solutions in Germany, France and the Netherlands..



Deutsche Kreditbank AG

Taubenstr. 7–9, 10117 Berlin
Tel.: +49 (0)30 12030-9930
Fax: +49 (0)30 12030-9902
E-Mail: joerg-uwe.fischer@dkb.de
www.dkb.de/erneuerbare-energien

We finance your wind energy project. Our energy experts and engineers will support you every step of the way and, if necessary, provide you with public funding.



DZ BANK AG

Platz der Republik, 60265 Frankfurt
Tel.: +49 (0)40 35900-496
Fax: +49 (0)40 35900-351
E-Mail: alexandra.pohl@dzbank.de
www.dzbank.com

DZ BANK's regional renewable energy teams make their in-depth expertise available for the assessment, structuring and financing of onshore wind energy projects.

Energy Invest Consulting AG



Energy Invest Consulting AG

Sihlstrasse 95, 8001 Zürich
Tel.: +41 (0)44 3901747
Fax: +41 (0)44 3901749
E-Mail: hoffmann@energyinvest.ch
www.energyinvest.ch

Energy Invest Consulting AG has been an independent adviser since 2007 for investments in renewable energy with focus on wind and solar energy in Germany, France, Italy and Spain.



Hamburg Commercial Bank AG

Gerhart-Hauptmann-Platz 50, 20095 Hamburg
Tel.: +49 (0)40 3333-0
Fax: +49 (0)40 3333-34001
E-Mail: nils.driemeyer@hcob-bank.com
www.hcob-bank.de

Hamburg Commercial Bank is one of the leading European experts for project financing in the field of renewables. We offer comprehensive know-how and are a reliable long-term partner.



Investitionsbank Schleswig-Holstein (IB.SH)

Fleethörn 29–31, 24103 Kiel
Tel.: +49 (0)431 9905-0
Fax: +49 (0)431 9905-3383
E-Mail: info@ib-sh.de
www.ib-sh.de/en

Investitionsbank Schleswig-Holstein (IB.SH) is the central development bank of the federal state of Schleswig-Holstein.



Landwirtschaftliche Rentenbank

Hochstrasse 2, 60313 Frankfurt am Main
Tel.: +49 (0)69 2107-700
Fax: +49 (0)69 2107-6459
E-Mail: office@rentenbank.de
www.rentenbank.de

Rentenbank, Germany's development bank for agriculture and rural areas, offers low-interest financing for the generation, storage and distribution of renewable energies, among other things.



NORD/LB

Friedrichswall 10, 30159 Hannover
Tel.: +49 (0)441 237-1667 G.Schmidt (nat. Proj.);
+49 (0)511 361-6696 H.Vogler (intern. Proj.)
E-Mail: henning.vogler@nordlb.de;
gerrit.schmidt@nordlb.de
www.nordlb.de

Our bank has been involved in financing renewable energy projects since the mid-1990s. With numerous project financing and advisory mandates for wind farms we are one of the top arrangers.



reconcept. Green Global Investments

ABC-Strasse 45, 20354 Hamburg
Tel.: +49 (0)40 3252165-0
Fax: +49 (0)40 3252165-69
E-Mail: info@reconcept.de
www.reconcept.de

reconcept is one of Germany's pioneers investing in renewable energy. Looking back at more than 20 years of investment experience, reconcept provides access to high-quality investment opportunities.



UmweltBank AG

Laufertorgraben 6, 90489 Nürnberg
Tel.: +49 (0)911 5308-175
Fax: +49 (0)911 5308-179
E-Mail: projektfinanzierung@umweltbank.de
www.umweltbank.de

We are Germany's greenest bank – by conviction. For over 20 years, we have been following our vision of “100 per cent renewable energies” and can look back with pride on the more than 27,700 environmental projects we have funded.



Consulting & business consulting



BET Büro für Energiewirtschaft und technische Planung GmbH

Alfonsstr. 44, 52070 Aachen
Tel.: +49 (0)241 47062-400
Fax: +49 (0)241 47062-600
E-Mail: info@bet-aachen.de
www.bet-aachen.de

B E T supports players along the entire value chain, including developments in electricity prices and market values, tenders, procurement and marketing concepts, PPAs and grid integration.



BOEHM-BEZING & CIE.

Boehm-Bezing & Cie. GmbH

Staffenbergstr. 44, 70184 Stuttgart
Tel.: +49 (0)711 722082-0
Fax: +49 (0)711 722082-99
E-Mail: boehm-bezing@bbcie.de
www.bbcie.de/index_en.html

Since 1999, Boehm-Bezing & Cie. has been one of the leading independent advisory firms in Germany for Corporate Finance and M&A, with special expertise in renewable energy and infrastructure.



Deutsche WindGuard

Oldenburger Str. 65, 26316 Varel
Tel.: +49 (0)4451 9515-0
Fax: +49 (0)4451 9515-29
E-Mail: info@windguard.de
www.windguard.com

Due diligence, tender and contract consulting, wind turbine type and manufacturer assessment, analysis of operational wind farms, policy consulting & studies, market analysis.



EcofinConcept GmbH

Rheinstr. 7, 41836 Hückelhoven
Tel.: +49 (0)2433 970-471
Fax: +49 (0)2433 970-107
E-Mail: info@ecofinconcept.de
www.ecofinconcept.de
Project development, acquisitions, project management, consultancy, procurement, financial concepts, private placements, transaction management, investments, windfarms, single turbines, repowering, EEG20+



enervis energy advisors GmbH

Schlesische Str. 29–30, 10997 Berlin
Tel.: +49 (0)30 695175-0
Fax: +49 (0)30 695175-20
E-Mail: kontakt@enervis.de
www.enervis.de

Business development for renewables: assessment of wind projects, due diligence, direct marketing, market value and revenue reports, auction model, market analyses for RES auctions



Tractebel Engineering GmbH

Friedberger Str. 173, 61118 Bad Vilbel
Tel.: +49 (0)6101 55-1784
Fax: +49 (0)6101 55-1826
E-Mail: info-de@tractebel.engie.com
www.tractebel-engie.com/en/solutions/energy#renewables

Tractebel Engineering GmbH offers world-wide planning and consulting services for onshore and offshore wind farm projects as well as wind expertises according to ISO 17025.



Wind Multiplikator GmbH

Konsul-Smidt-Str. 71, 28217 Bremen
Tel.: +49 (0)421 399874902
E-Mail: r.bents@windmultiplikator.de
www.windmultiplikator.de

Wind Multiplikator GmbH is an expert in the offshore wind energy sector specialized in the management of offshore wind projects as well as in the provision of consulting and engineering services.



Wind Multiplikator QHSE GmbH

Konsul-Smidt-Str. 71, 28217 Bremen
Tel.: +49 (0)421 39987-4913
E-Mail: r.bents@windmultiplikator.de
www.windmultiplikator.de

Wind Multiplikator QHSE GmbH attends in the sector of offshore wind energy to all quality issues and handles projects dealing with occupational, health, and environmental safety.

Fund providers



Commerz Real

Kapitalverwaltungsgesellschaft mbH

Mercedesstr. 6, 40470 Düsseldorf
Tel.: +49 (0)211 7708-0
E-Mail: institutional@commerzreal.com
www.institutional.commerzreal.com

Commerz Real KVG manages structured real assets' investments in real estate (micro apartment complexes, hotels), renewable energies and infrastructure for (semi-) professional investors.



ENERTRAG Energielvest GmbH

Gut Dauerthal, 17291 Dauerthal
Tel.: 0800 0363 787
Fax: +49 (0)39854 6459-456
E-Mail: invest@enertrag.com
invest.enertrag.com

The ENERTRAG service team ensures the commercial success of your wind turbine. We take on servicing, inspection, preventive maintenance, repair and the exchange of large components.



Manufacturer and supplier advisory board



Expert consulting advisory board



Investors' advisory board



Expert consulting advisory board



Scientific advisory board



Operators' advisory board

Insurance companies



Aon Versicherungsmakler Deutschland GmbH

Caffamacherreihe 16, 20355 Hamburg

Tel.: +49 (0)40 3605-0

Fax: +49 (0)40 3605-1000

E-Mail: power@aon.de

www.aon.com

International risk advisory and insurance broking services for the renewable energy markets, in particular on- and offshore wind energy.



Contrust Versicherungsmakler GmbH

An der Steinernen Brücke 1, 85757 Karlsfeld

Tel.: +49 (0)8131 59390-60

Fax: +49 (0)8131 59390-80

E-Mail: julius.martni@contrast.com

www.contrust.com

Consulting in all risk and insurance matters for manufacturers, operators, engineering offices of wind energy projects (worldwide) and other renewables (biogas, photovoltaics (PV)).



Enser Versicherungskontor GmbH

An der Tigge 4, 59469 Ense

Tel.: +49 (0)2938 9780-0

Fax: +49 (0)2938 9780-30

E-Mail: info@evk-oberense.de

www.evk-oberense.de

One of the leading brokers in the renewable energy market, serving over 10.000 clients world-wide, utilising the expertise as an operator, own concepts of insurance cover and own claim engineers.



Nordwest Assekuranzmakler GmbH & Co. KG

Herrlichkeit 5-6, 28199 Bremen

Tel.: +49 (0)421 989607-0

Fax: +49 (0)421 989607-209

E-Mail: info@nw-assekuranz.de

www.nw-assekuranz.de

Wind energy (on-/offshore, national/international), biogas/biomass, solar & photovoltaics, biodiesel, bioethanol & geothermal energy.



R+V Versicherung AG

Raiffeisenplatz 1, 65189 Wiesbaden

Tel.: +49 (0)40 23606-5855

E-Mail: agrarpartner@ruv.de

www.ruv.de/firmenkunden/erneuerbare-energien/windenergie

R+V is one of the largest German insurance companies with over 8 million customers and 15 bn euros premium income. Our efficient service and collaborative approach set us apart from competitors.



Blanke Meier Evers

Stephanitorsbollwerk 1 (Haus LEE), 28217 Bremen

Grosse Johannisstrasse 9, 20457 Hamburg

Tel.: +49 (0)421 94946-0 / +49 (0)40 4321876-0

Fax: +49 (0)421 94946-66 / +49 (0)40 4321876-11

E-Mail: info@bme-law.de

www.bme-law.de/home.html

Legal services in connection with renewable energy projects. This specifically concerns energy law, project finance, corporate finance, company law, tax law, contract law and public law.

Lawyers



Aktiva Gruppe

Am Nesseufer 14, 26789 Leer

Tel.: +49 (0)491 92990-0

Fax: +49 (0)491 92990-199

E-Mail: florian.bischof@aktiva-gruppe.de

www.aktiva-gruppe.de

The companies of AKTIVA Group advise initiators of collective investments in renewable energies across Europe. We are experts in giving legal and tax assistance to investment companies.

Buse Heberer Fromm

Rechtsanwälte Steuerberater PartG mbB

Harvestehuder Weg 23, 20149 Hamburg

Tel.: +49 (0)40 41999-403

Fax: +49 (0)40 41999-169

E-Mail: zielke@buse.de

www.buse.de

Having 20 years of experience in the renewables sector we offer legal full service with national/ intern. transactions (due diligence, M&A, finance) and as well with planning and project management.



Dr. jur. Jörg Niedersberg

Hafenhaus-Bollhoernkai 1, 24103 Kiel

Tel.: +49 (0)431 98389-22

Fax: +49 (0)431 98389-66

E-Mail: kanzlei@anwalt-energie.de

www.anwalt-energie.de

Specialist in administrative law, contract law, environmental law, energy industry law, energy cartel law.



Becker Büttner Held

Magazinstrasse 15-16, 10179 Berlin

Tel.: +49 (0)30 6112840-0

Fax: +49 (0)30 6112840-99

E-Mail: bbh@bbh-online.de

www.bbh-online.de

BBH advises the energy sector with particular focus on renewable energies. We counsel on project planning, grids, feed-in management, remuneration, and direct marketing.



Engemann und Partner,

Rechtsanwälte mbB

Kastanienweg 9, 59555 Lippestadt

Tel.: +49 (0)2941 9700-0

Fax: +49 (0)2941 9700-50

E-Mail: a.lahme@engemann-und-partner.de

www.engemann-und-partner.de

Competencies and experiences in the field of renewable energies, administrative law, environmental law, building law, energy law, public liability law, contract law.





Menold Bezler Rechtsanwälte Partnerschaft mbB

Rheinstahlstrasse 3, 70469 Stuttgart
Heilbronner Strasse 190, 70191 Stuttgart
Tel.: +49 (0)711 86040-710
Fax: +49 (0)711 86040-01
E-Mail: verena.roesner@menoldbezler.de
www.menoldbezler.com

We bring together competencies in company, energy, contract, environmental, building and planning law to help you maximise wind energy opportunities whilst minimising risks.



Osborne Clarke Rechtsanwälte Steuerberater Partnerschaft mbB

Innere Kanalstr. 15, 50823 Cologne
Tel.: +49 (0)221 5108453-0
Fax: +49 (0)221 5108453-1
E-Mail: daniel.breuer@osborneclarke.com
www.osborneclarke.com

Legal assistance for German and international projects and joint ventures throughout the renewable energy sector and comprehensive legal advice for companies and associations in the energy sector.



RWP Rechtsanwälte PartG mbB

Bleichstr. 8–10, 40211 Düsseldorf
Tel.: +49 (0)211 8679023
Fax: +49 (0)211 132785
E-Mail: a.gabler@rwp.de
www.rwp.de

Specialised consulting for wind energy projects, project development, grid connection, bottleneck management, direct marketing, storage, local supply, approval, acquisition/sale of projects.



Sterr-Kölln & Partner mbB

Emmy-Noether-Strasse 2, 79110 Freiburg
Tel.: +49 (0)761 490540
Fax: +49 (0)761 493468
E-Mail: info@sterr-koelln.com
www.sterr-koelln.com

Sterr-Kölln & Partner mbB is an interdisciplinary consultancy firm specialised on renewable energies and energy efficiency. We support our clients to successfully shape their energy future.



Taylor Wessing

Hanseatic Trade Center, Am Sandtorkai 41,
20457 Hamburg
Tel.: +49 (0)40 368030
E-Mail: c.bartholl@taylorwessing.com
www.taylorwessing.com

Taylor Wessing is a leading international law firm. The wind energy sector is a major focus of our services. We advise on project investment, project development as well as on financing issues.

Tax accountants



Aktiva Gruppe

Am Nesseufer 14, 26789 Leer
Tel.: +49 (0)491 92990-0
Fax: +49 (0)491 92990-199
E-Mail: florian.bischof@aktiva-gruppe.de
www.aktiva-gruppe.de

The companies of the AKTIVA Group advise initiators in the field of renewable energy across Germany. We have made a name for ourselves through our long-standing assistance to investment companies.



BDO ARBICON GmbH & Co. KG

Moslestrasse 3, 26122 Oldenburg
Tel.: +49 (0)441 98050-0
Fax: +49 (0)441 98050-180
E-Mail: info@bdo-arbicon.de
www.bdo-arbicon.de

BDO ARBICON is a medium-sized audit firm. For many years, wind energy and renewable energies have been the focus of the company's consulting activities.

Manufacturers

Wind turbines (> 100 kW)



ENERCON GmbH

Dreekamp 5, 26605 Aurich
Tel.: +49 (0)4941 927-0
Fax: +49 (0)4941 927-109
E-Mail: info@enercon.de
www.enercon.de/en

ENERCON products are known for their innovative technology, outstanding reliability and excellent returns on investment, worldwide.



eno energy Gruppe

Am Strande 2e, 18055 Rostock
Tel.: +49 (0)38296 746-0
Fax: +49 (0)381 203792-101
E-Mail: info@eno-energy.com
www.eno-energy.com

eno energy sees itself as all-round supplier in the area of onshore wind and offers the entire portfolio from planning through the production of turbines to service / maintenance and asset management.



GE Renewable Energy

Onshore Wind: Holsterfeld 16, 48499 Salzbergen
Offshore Wind: Sachsenfeld 2–4, 20097 Hamburg
Tel.: +49 (0)5971 980-0 / +49 (0)40 696 321-0
E-Mail: info_renewable.energy@ge.com,
antje.luehr@ge.com (Kontakt für Hamburg)
www.gerenewableenergy.com

Portfolio: 1.6 to 5.3 MW (Onshore) and 6 to 12 MW (Offshore) Support of project development, operation/maintenance, solutions for grid integration and commercial use of wind turbines.



Manufacturer and supplier advisory board



Expert consulting advisory board



Investors' advisory board



Expert consulting advisory board



Scientific advisory board



Operators' advisory board



Nordex Group

Langenhorner Chaussee 600, 22419 Hamburg
 Tel.: +49 (0)40 30030-1000
 Fax: +49 (0)40 30030-1100
 E-Mail: info@nordex-online.com
 www.nordex-online.com

The Nordex group offers powerful wind turbines for nearly all geographical regions across the globe.



Siemens Gamesa Renewable Energy GmbH & Co. KG

Beim Strohhaus 17–31, 20097 Hamburg
 Tel.: +49 (0)40 2889-0
 E-Mail: info@siemensgamesa.com
 www.siemensgamesa.com

Siemens Gamesa Renewable Energy offers onshore and offshore products as well as leading maintenance and upkeep services for making renewable energy affordable and reliable.



VENSYS Energy AG

Im Langental 6, 66539 Neunkirchen
 Tel.: +49 (0)6821 9517-0
 E-Mail: vertrieb@vensys.de
 www.vensys.de

VENSYS offers gearless wind turbines for all wind classes and locations.

Operation & service

Quality assurance



GOM GmbH

Schmitzstrasse 2, 38122 Braunschweig
 Tel.: +49 (0)531 39029-0
 Fax: +49 (0)531 39029-15
 E-Mail: info@gom.com
 www.gom.com

GOM is a global manufacturer that develops, produces and distributes software, machines and systems for industrial and automated 3D coordinate measuring technology and 3D testing.



BayWa r.e. Rotor Service GmbH

Am Diesterkamp 63, 27432 Basdahl
 Tel.: +49 (0)4766 821-100
 Fax: +49 (0)4766 821-233
 E-Mail: rotorservice@baywa-re.com
 www.baywa-re.com

Servicing & maintenance, regardless of manufacturer, for all rotor blade types on site or hangar supported, cleaning & corrosion protection, heavy-duty transportation & logistics, storage & disposal.



BIL eG

Josef-Wirmer-Str. 1–3, 53123 Bonn
 Tel.: +49 (0)228 92585290
 E-Mail: info@bil-leitungsauskuft.de
 www.bil-leitungsauskuft.de

BIL – The nationwide information system for power line enquiries offers twice the benefit for the wind energy sector.



Service, maintenance & repair



ABO Wind AG

Oberdorfstr. 10, 55262 Heidesheim
 Tel.: +49 (0)6132 8988-00
 Fax: +49 (0)6132 8988-29
 E-Mail: vertrieb@abo-wind.de
 www.abo-wind.com

Partial and full maintenance, replacement of large components, electrical testing, repairs: The decentralised ABO Wind Service maintains, tests, inspects and repairs wind turbines across Europe.

blade care GmbH

Neuenfeld 41, 17291 Schoenefeld
 Tel.: +49 (0)163 8860079
 E-Mail: post@bladecare.de
 www.bladecare-academy.com

blade care GmbH provides service for rotor blades (inspection & repair). blade care Academy is certified by DNV-GL. Seminars & training for administrators and technicians on blade awareness & repair.



BRAUER Maschinentechnik AG

Raffeisenring 25, 46395 Bocholt
 Tel.: +49 (0)2871 7033
 Fax: +49 (0)2871 7036

E-Mail: j.brauer@brauer-getriebe.de
 www.brauer-getriebe.de
 Repair and improvement of wind turbine gearboxes of all types and in every size.



Aero Enterprise GmbH

Industriezeile 35, 4020 Linz
 Tel.: +43 (0)7435 21110100
 E-Mail: office@aero-enterprise.com
 www.aero-enterprise.com

Aero Enterprise offers a full-service package for the airborne inspection of on- and offshore wind turbines by the use of the self-developed hardware *AERO-SensorCopter* and the *AERO-Software Package*.





Buss Wind Services GmbH

Stockenkamp 15a, 27793 Wildeshausen
 Tel.: +49 (0)4431 738090
 Fax: +49 (0)4431 73809-10
 E-Mail: bws@buss-group.com
 www.buss-group.com

Buss Wind Services has over 15 years of experience in the installation, commissioning and maintenance of wind turbines and rotor blades.



Connected Wind Services Deutschland GmbH

Mühlenberg 19, 25873 Rantrum
 Tel.: +49 (0)4848 90128-0
 Fax: +49 (0)4848 90128-22
 E-Mail: info.de@connectedwind.com
 www.connectedwind.com

Connected Wind Services: Whether it's service projects, operational support, gearbox refurbishment and replacement or spare parts, you can always count on a dedicated effort to protect your assets.



cp.max Rotortechnik GmbH & Co. KG

Manfred-von-Ardenne-Ring 5, 01099 Dresden
 Tel.: +49 (0)351 8589345-0
 Fax: +49 (0)351 8589345-77
 E-Mail: info@cpmax.com
 www.cpmx.com
 Specialist in rotor blades.



Deutsche Windtechnik

Stephanitorsbollwerk 1 (Haus LEE), 28217 Bremen
 Tel.: +49 (0)421 69105-0
 Fax: +49 (0)421 69105-499
 E-Mail: info@deutsche-windtechnik.com
 www.deutsche-windtechnik.com
 Independent full scope O&M provider for multibrand wind turbine technologies, onshore and offshore: Full and basic maintenance, repairs, expert reports, QHSE, management services, repowering and more

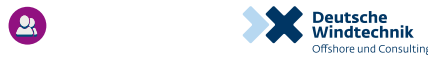

Deutsche Windtechnik Offshore und Consulting GmbH

Stephanitorsbollwerk 1 (Haus LEE), 28217 Bremen
 Tel.: +49 (0)421 69105-0
 Fax: +49 (0)421 69105-299
 E-Mail: info-dwtoc@deutsche-windtechnik.com
 www.deutsche-windtechnik.com
 Deutsche Windtechnik Offshore und Consulting provides maintenance for complete offshore windfarms and substations – Full-Service above as well as under water.



Deutsche Windtechnik Rotor und Turm GmbH & Co. KG

Hüttenstr. 20a, 28237 Bremen
 Tel.: +49 (0)421 626770
 Fax: +49 (0)421 6267711
 E-Mail: info-rt@deutsche-windtechnik.com
 www.deutsche-windtechnik.com
 Rotor blade service, towers and foundations, safety technology, electrical technology, qualification at Training Center Bremen



Deutsche Windtechnik Service GmbH & Co. KG

Osterport 2e, 25872 Ostensefeld
 Tel.: +49 (0)4845 79168-0
 Fax: +49 (0)4845 79168-29
 E-Mail: info-dwts@deutsche-windtechnik.com
 www.deutsche-windtechnik.com
 (Full) maintenance with focus on Vestas, NEG-Micon, Siemens/AN Bonus, Gamesa, Enercon, service, replacement parts, component exchange, retrofits, monitoring, optimization, consultancy.



Deutsche Windtechnik X-Service GmbH

Heideweg 2–4, 49086 Osnabrück
 Tel.: +49 (0)541 380538-100
 Fax: +49 (0)541 380538-199
 E-Mail: info-dwtx@deutsche-windtechnik.com
 www.deutsche-windtechnik.com
 The independent service provider Deutsche Windtechnik X-Service is specialised in Nordex, Fuhrländer & Senvion. The service includes maintenance, 24/7 remote monitoring, repair and technical management.



EnBW Energie Baden-Württemberg AG

Schelmenwasenstrasse 15, 70567 Stuttgart
 Tel.: +49 (0)711 289-89844
 Fax: +49 (0)711 289-87264
 E-Mail: betriebsfuehrung-wind@enbw.com
 www.enbw.com/windonshore-betrieb
 Manufacturer-independent but with at least the same level of quality, quick availability, efficiency and fast response times.



ENERTRAG Service GmbH

Gut Dauerthal, 17291 Dauerthal
 Tel.: +49 (0)39854 6459-0
 Fax: +49 (0)5404 9170-492
 E-Mail: service@enertrag.com
 www.enertrag.com
 The ENERTRAG service team ensures the commercial success of your wind turbine. We take on servicing, inspection, preventive maintenance, repair and the exchange of large components.



FLYTEG GmbH & Co. KG

Carl-Zeiss-Str. 13, 24568 Kaltenkirchen
 Tel.: +49 (0)4191 9912794
 Fax: +49 (0)4191 9912794
 E-Mail: office@flyteg.com
 www.flyteg.com
 FLYTEG GmbH & Co. KG specializes in busbar repair in wind turbines. We offer mold removal, corrosion protection, oil and fire damage elimination, blade inspection in rope technology.



Framatome GmbH

Paul-Gossen-Str. 100, 91052 Erlangen
 Tel.: +49 (0)9131 900-31548
 Fax: +49 (0)9131 900-94020
 E-Mail: wind@framatome.com
 www.framatome.com/solutions-portfolio/wind
 Root Cause Analyses; accredited test labs; materials, corrosion, welding consulting; Fitness-for-Service assessments; NDE; inspections using manipulators; quality assurance



Manufacturer and supplier advisory board



Expert consulting advisory board



Investors' advisory board



Expert consulting advisory board



Scientific advisory board



Operators' advisory board



GAIA mbH

Jahnstrasse 28, 67245 Lamsheim
 Tel.: +49 (0)6233 35944-00
 Fax: +49 (0)6233 35944-01
 E-Mail: info@gaia-mbh.de
 www.gaia-mbh.de

Your professional partner for planning, development, project coordination and storage solutions; servicing and technical management of wind turbines and photovoltaic systems as well as co-gen plants.



GfM Gesellschaft für Maschinendiagnose mbH

Köpenicker Strasse 325, 12555 Berlin
 Tel.: +49 (0)30 65762565
 Fax: +49 (0)30 65762564
 E-Mail: mailbox@maschinendiagnose.de
 www.maschinendiagnose.de

Vibration Diagnosis | Inspection | Videendoscopy
 | Blade Bearing Diagnosis | Foundation Monitoring
 | Torque Analysis



Green Wind Offshore GmbH

Alt-Moabit 60a, 10555 Berlin
 Tel.: +49 (0)30 3512886-30
 Fax: +49 (0)30 3512886-33
 E-Mail: berlin@greenwindoffshore.de
 www.greenwind.berlin

Green Wind specializes in project development as well as the technical and commercial operation of onshore and offshore wind turbines and the platform management of HVDC and substations. Based in Berlin, Green Wind boasts *greenwind control* – an independent, state-of-the-art 24/7 control center.



Grzib Elektrotechnik GmbH & Co. KG

Zur Kokerei 21, 46117 Oberhausen
 Tel.: +49 (0)208 884839-24
 Fax: +49 (0)208 884839-26
 E-Mail: info@grzib-elektrotechnik.de
 www.grzib-elektrotechnik.de
 Europe-wide electrical installation of wind turbines
 | DGUV V3 tests | Maintenance & service of transformers, MV switchgear, converters | Removal of faults according to expert specifications



Koopmann Gruppe

Zum Brook 19–21, 49661 Cloppenburg
 Tel.: +49 (0) 4471 9494-0
 Fax: +49 (0)4471 84895
 E-Mail: info@hk-c.de
 www.hk-c.de

The Koopmann Group is one of Germany's leading specialists for energy and electrical engineering. Wind industry services: Cable testing, power plant assembly, circuit breaker servicing, testing & diagnosis, transformer servicing, power centres, protective engineering and operational management.



Kreuzwind Schmieder & Schmidt GbR

Hoyerswerdaer Strasse 34, 1099 Dresden
 Tel.: +49 (0)351 40758321
 Fax: +49 (0)351 32012826
 E-Mail: s.schmieder@kreuzwind.com
 www.kreuzwind.com

Your reliable partner for the dismantling and recycling of wind turbines of all types. From controlled dismantling to the renaturation of the site – everything from one source!



KTW Umweltschutztechnik GmbH

Magdalaer Str. 102a, 99441 Mellingen
 Tel.: +49 (0)36453 8750
 Fax: +49 (0)36453 87511
 E-Mail: info@ktweimar.de
 www.ktweimar.de

KTW Umweltschutztechnik GmbH provides foundations and towers with highly elastic seals and coatings, concrete repair and strengthening with life-tested products (even at high altitude, for example hybrid towers).



Multigear GmbH

Am Flugplatz 34, 56743 Mendig
 Tel.: +49 (0)2652 93605-0
 Fax: +49 (0)2652 93605-20
 E-Mail: info@multigear.de
 www.multigear.de
 Independent service provider. New and exchange gearboxes, inspection & overhaul, modification, spare parts management, endoscopy, project consultancy, 24h/7 hotline +49 (0)174-3500600.



N.T.E.S. GmbH

Handelshof 8, 27432 Bremervörde
 Tel.: +49 (0)4761 92612-0
 Fax: +49 (0)4761 92612-99
 E-Mail: wkas@ntes-service.de
 www.ntes-service.de

Wind turbines: Maintenance, repair, inspection, measurements, thermography for Bonus/Siemens turbines.



POLYGONVATRO GmbH

Raiffeisenstrasse 25, 57462 Olpe
 Tel.: +49 (0)2762 986828
 E-Mail: andreas.ferdinand@polygonvatro.de
 www.polygonvatro.de

POLYGONVATRO offers a range of services within the areas of property damage restoration after fire, water & climate events. For WT we offer renovation services & 3D blade tests. ALWAYS BY YOUR SIDE



psm Nature Power Service & Management GmbH & Co. KG

Juelicher Strasse 10–12, 41812 Erkelenz
 Tel.: +49 (0)2431 9733-6
 Fax: +49 (0)2431 9733-777
 E-Mail: service@psm-service.com
 www.psm-service.com

psm offers maintenance and repair for Servion, Nordex, GE, Fuhrlaender, DeWind, NEG Micon, WindWorld.



REETEC GmbH

Konsul-Smidt-Str. 71, 28217 Bremen
 Tel.: +49 (0)421 39987-0
 Fax: +49 (0)421 39987-11
 E-Mail: info@reetec.de
 www.reetec.de

Onshore & offshore: regular maintenance, retrofit programs, grid quality measurement, WTG inspection & troubleshooting, rotor blade & tower service, major component replacement





REWITEC GmbH

Dr.-Hans-Wilhelmi-Weg 1, 35633 Lahnau
Tel.: +49 (0)6441 44599-0
Fax: +49 (0)6441 44599-25
E-Mail: info@rewitec.com
www.rewitec.com

REWITEC® technology for wind turbines. Reduces friction and wear in gearboxes and bearings of all types. It significantly increases service life and energy efficiency of your wind turbine.



SpanSet Axzion GmbH

Winkelsweg 172, 40764 Langenfeld
Tel.: +49 (0)2173 208920
E-Mail: wind@axzion.de
www.axzion.de

SpanSet Axzion sees itself as a provider of consultancy services and systems. All components are carefully matched, tested and certified before being sold as a complete system and made operational.



Wind-Tech Services Rechlin GmbH

Müritzstrasse 11, 17248 Rechlin
Tel.: +49 (0)39823 27033-4
Fax: +49 (0)39823 27033-6
E-Mail: info@wind-tech-services.de
www.wind-tech-services.de

Extensive support for your wind turbine and employees. Maintenance / Repair / Inspection / Training



ROSCH Industrieservice GmbH

Bernardstr. 29, 49809 Lingen
Tel.: +49 (0)591 800990-10
Fax: +49 (0)591 800990-19
E-Mail: info@rosch-industrieservice.de
www.rosch-industrieservice.de

We offer our clients worldwide a reliable, professional service for flawless, efficient operation of complete wind turbines, both on- and offshore.



Sulzer & Schmid Laboratories AG

Industriestrasse 9, 8618 Oetwil am See, Switzerland
Tel.: +41 (0)55 508 17 15
E-Mail: info@sulzerschmid.ch
www.sulzerschmid.ch

Rotor blade inspections via autonomous drones is the core of our business at Sulzer Schmid, a Swiss technology company and innovator of next-generation technology for the inspection of wind turbines.



Windservice Westerwald GmbH

Bahnhofstrasse 2, 35767 Breitscheid
Tel.: +49 (0)2777 812880-0
Fax: +49 (0)2777 812880-9
E-Mail: info@windservice-westerwald.de
www.windservice-westerwald.de

Windservice Westerwald is a service company which works at rotor blades and components of the plants built by GRP. Furthermore, we have an innovative method for removing broken threaded connections.



Rotor Control GmbH

Kennedy Weg 3, 25821 Struckum
Tel.: +49 (0)4671 933440-0
Fax: +49 (0)4671 933440-19
E-Mail: info@rotor-control.de
www.rotor-control.de

Your partner for maintenance, repair and assessment of rotor blades/towers irrespective of WTG type or hub height, wind turbine maintenance and expert advice according to BDS.



Triflex GmbH & Co. KG

Karlstrasse 59, 32423 Minden
Tel.: +49 (0)571 38780-0
Fax: +49 (0)571 38780-738
E-Mail: info@triflex.de
www.triflex.com

Triflex is Europe's leading manufacturer of PMMA liquid plastic waterproofing systems and, with Triflex Towersafe, offers an excellent waterproofing solution for the tower and foundation area of wind turbines.



Winergy

Am Industriepark 2, 46562 Voerde
Tel.: +49 (0)2871 92-4
Fax: +49 (0)2871 92-2487
E-Mail: info@winergy-group.com
www.winergy-group.com

Service – you can trust in high reliability! Winergy offers a broad service portfolio which is globally provided through Winergy service facilities or certified partners.



RTS Wind AG

Am Winterhafen 3a, 28217 Bremen
Tel.: +49 (0)421 696800-00
Fax: +49 (0)421 696800-99
E-Mail: info@rts-wind.de
www.rts-wind.de

RTS Wind AG is a global service provider in the field of installation, operation and maintenance of wind turbines – onshore and offshore – as well as rotor blade service..



VSB Technik GmbH

Schweizer Str. 3a, 01069 Dresden
Tel.: +49 (0)351 21183-400
Fax: +49 (0)351 21183-44
E-Mail: info@vsb.energy
www.vsb.energy

Maintenance and repair of wind power plants, service partner for ENERCON, 24/7 online remote surveillance, Spare part management, Rotor-blade scan, Testing in accordance with DGUV 3, Repowering



WKA Blade Service GmbH

Heiweg 119, 23566 Lübeck
Tel.: +49 (0)451 406090-20
E-Mail: info@wkabladeservice.com
www.wkabladeservice.com

Warranted quality and 25 years of experience make WKA the most reliable partner for repairs and Service of all rotor blade types. We use rope-access and platform technology and also install upgrades.



Manufacturer and supplier advisory board



Expert consulting advisory board



Investors' advisory board



Expert consulting advisory board



Scientific advisory board



Operators' advisory board

Technical & commercial operational management



ABO Wind AG

Oberdorfstr. 10, 55262 Heidesheim
 Tel.: +49 (0)6132 8988-00
 Fax: +49 (0)6132 8988-29
 E-Mail: kontakt@abo-wind.de
 www.abo-wind.com
 Technical & commercial operations management, 24/7 remote monitoring, contract management, permit requirements: ABO Wind manages and optimises plants with a capacity of 1,700 megawatts across Europe.



AIRWIN GmbH

Simplonstrasse 56, 10245 Berlin
 Tel.: +49 (0)30 346557160
 Fax: +49 (0)30 346557179
 E-Mail: info@airwin.de
 www.airwin.de
 Technical and commercial management of wind turbines and solar installations, competent partner for consulting services and portfolio management.



BayWa r.e. Operation Services GmbH

Arabellastrasse 4, 81925 Munich
 Tel.: +49 (0)89 383932-0
 Fax: +49 (0)89 383932-32
 E-Mail: operation-services@baywa-re.com
 www.baywa-re.com
 Technical and commercial management, 24/7 control centre, international experts team, support under one roof, on-site service, full responsibility for the plant, high voltage maintenance and measurements.



BGZ Fondsverwaltung GmbH

Otto-Hahn-Str. 12–16, 25813 Husum
 Tel.: +49 (0)4841 8944-825
 Fax: +49 (0)4841 8944-840
 E-Mail: info@bgz-gmbh.de
 www.bgz-gmbh.de/en
 Management and repowering of renewable energy farms.



Deutsche WindGuard

Oldenburger Str. 65, 26316 Varel
 Tel.: +49 (0)4451 9515-0
 Fax: +49 (0)4451 9515-29
 E-Mail: i.soerensen@windguard.de
 www.windguard.com
 Techn. & comm. management (on- & offshore)
 DIN 31051, condition oriented maintenance, maintenance management, repair management, monitoring, plant and operator responsibility acc. to VDE 0105-100.



Dirkshof / EED GmbH & Co. KG

Sönke-Nissen-Koog 58, 25821 Reußenköge
 Tel.: +49 (0)4674 9629-0
 Fax: +49 (0)4674 827 9999
 E-Mail: info@dirkshof.de
 www.dirkshof.de
 Dirkshof – Renewable Energy. German Expertise in Wind Energy – since 1989.



EnBW Energie Baden-Württemberg AG

Durlacher Allee 93, 76131 Karlsruhe
 Tel.: +49 (0)711 289-89844
 E-Mail: betriebsfuehrung-wind@enbw.com
 www.enbw.com
 We ensure the economic and environmentally friendly operation of a wide variety of wind power plant types and sizes with 24/7 remote monitoring.



ENERTRAG Windstrom GmbH

Gut Dauerthal, 17291 Dauerthal
 Tel.: +49 (0)180 39732-88
 E-Mail: windstrom@enertrag.com
 windstrom.enertrag.com
 The wind power optimisers: We offer commercial and technical competence from over 20 years of experience in managing systems under the German Renewable Energy Act.

GP JOULE Service GmbH & Co. KG

Cecilienkoog 16, 25821 Reußenköge
 Tel.: +49 (0)4671 6074-0
 E-Mail: info@gp-joule.de
 www.gp-joule.de
 GP JOULE SERVICE offers more than just one-off commercial and technical management. We stand for certified quality, across Germany and internationally.



Green Wind Operations GmbH

Alt-Moabit 60 a, 10555 Berlin
 Tel.: +49 (0)30 3512886-30
 Fax: +49 (0)30 3512886-33
 E-Mail: berlin@greenwindoperations.de
 www.greenwind.berlin
 Green Wind specializes in project development as well as the technical and commercial operation of onshore and offshore wind turbines and the platform management of HVDC and substations. Based in Berlin, Green Wind boasts *greenwind control* – an independent, state-of-the-art 24/7 control center.



juwi Operations & Maintenance GmbH

Energie-Allee 1, 55286 Wörrstadt
 Tel.: +49 (0)6732 9657-5090
 Fax: +49 (0)6732 9657-7001
 E-Mail: info@juwi-om.de
 www.juwi-om.de
 Your energy plants in good hands: We offer a complete service package comprising technical and commercial services as well as maintenance for wind energy and PV plants, optimizing your yields.



Kaiserwetter Energy Asset Management GmbH

Hopfenmarkt 33, 20457 Hamburg
 Tel.: +49 (0)40 530566-0
 Fax: +49 (0)40 530566-199
 E-Mail: ger@kaiserwetter.eu
 www.kaiserwetter.energy
 Kaiserwetter is an independent service provider for the asset, portfolio and risk management of renewable energy assets. The company uses big data analytics and the Internet of Things (IoT).





PIONEXT GmbH

Gartenstraße 22, 55232 Alzey
 Tel.: +49 (0)6731 405-0
 E-Mail: info@pionext.de
 www.pionext.de
 Flexible and individual operational management including 24/7 monitoring, regular inspections, documentation of processes and operations, medium voltage infrastructure management and IT security.



psm Nature Power Service & Management GmbH & Co. KG

Juelicher Strasse 10–12, 41812 Erkelenz
 Tel.: +49 (0)2431 9733-6
 Fax: +49 (0)2431 9733-777
 E-Mail: service@psm-service.com
 www.psm-service.com
 psm is an independent service provider offering complete technical and commercial management for windfarms and solar parks.



Regenerative Energien Zernsee GmbH & Co. KG

Bergstrasse 1, 12169 Berlin
 Tel.: +49 (0)30 22445983-0
 Fax: +49 (0)30 22445983-1
 E-Mail: zentrale@rez-windparks.de
 www.rez-windparks.de
 REZ can take over everything from the technical and commercial management right up to managing the entire business. And this includes site management.



Sabowind Service GmbH

Frauensteiner Strasse 118, 09599 Freiberg
 Tel.: +49 (0)3731 260860
 Fax: +49 (0)3731 260861
 E-Mail: service@sabowind.de
 www.sabowind.de/service/en
 Techn. and commercial management of WET in Germany and Poland, 24h monitoring, switching operations, technical reporting, maintenance, repair, direct marketing of energy, contract and insurance mgmt.



THEOLIA Naturenergien GmbH

Ulmer Str. 4, 70771 Leinfelden-Echterdingen
 Tel.: +49 (0)711 23860-0
 Fax: +49 (0)711 23860-99
 E-Mail: kundenservice@futuren-group.com
 www.windparkbetreuung.de
 Technical and commercial operational managers with modular operational management concept.



Volta Windkraft GmbH

Tückelhäuser Strasse 10, 97199 Ochsenfurt
 Tel.: +49 (0)9331 98494-0
 Fax: +49 (0)9331 98494-20
 E-Mail: info@voltawind.de
 www.voltawind.de
 Planning and construction of wind turbines including supervision of the approval process, technical and commercial support of the operation as well as support and implementation of civil wind turbines.



VSB Service GmbH

Schweizer Str. 3a, 01069 Dresden
 Tel.: +49 (0)351 21183-400
 Fax: +49 (0)351 21183-44
 E-Mail: info@vsb.energy
 www.vsb.energy/service
 Technical and commercial management for wind and solar power plants as well as substations, 24/7 online remote surveillance, direct marketing, occupational safety, managing of insurances and contracts

Windwärts Energie GmbH

Hanomaghof 1, 30449 Hannover
 Tel.: +49 (0)511 123573-0
 Fax: +49 (0)511 123573-190
 E-Mail: info@windwaerts.de
 www.windwaerts.de
 Windwärts provides a broad range of individual or packaged technical and commercial operational management services for both wind farms and solar parks.



wpd windmanager GmbH & Co. KG

Stephanitorsbollwerk 3 (Haus LUV), 28217 Bremen
 Tel.: +49 (0)421 897660-0
 Fax: +49 (0)421 897660-99
 E-Mail: windmanager@wpd.de
 www.windmanager.de
 All services from a single source – that's efficient wind farm management. Optimized operation of wind farms, guaranteed through our long-term experience and comprehensive market knowledge.



WestWind Service GmbH & Co. KG

Brinkstrasse 25, 27245 Kirchdorf
 Tel.: +49 (0)4273 9339-0
 Fax: +49 (0)4273 9339-44
 E-Mail: webkontakt@w-wind.de
 www.w-wind.de
 Service, operation and maintenance as well as technical and commercial management



Manufacturer and supplier advisory board



Expert consulting advisory board



Investors' advisory board



Expert consulting advisory board



Scientific advisory board



Operators' advisory board

Organisations & public institutions

Associations



BEE – German Renewable Energy Federation
 Invalidenstrasse 91, 10115 Berlin
 Tel.: +49 (0)30 2758170-0
 Fax: +49 (0)30 2758170-20
 E-Mail: info@bee-ev.de
 www.bee-ev.de



BWE – German Wind Energy Association
 Neustädtische Kirchstr. 6, 10117 Berlin
 Tel.: +49 (0)30 212341-210
 Fax: +49 (0)30 212341-410
 E-Mail: info@wind-energie.de
 www.wind-energie.de

Institutions



WTSH – Business Development and Technology Transfer Corporation of Schleswig-Holstein GmbH
 Lorentzendam 24, 24103 Kiel
 Tel.: +49 (0)431 66666-878
 E-Mail: hamel@wtsh.de
 www.wtsh.de
 Schleswig-Holstein offers a positive climate for investing in the wind energy industry. And WTSH provides as a competent partner advice for founding, expanding or relocating businesses.

Other services

Development & construction



CWD Aachen GmbH – Center for Wind Power Drives
 Mathieustrasse 30, 52074 Aachen
 Tel.: +49 (0)241 8095662
 Fax: +49 (0)241 8092885
 E-Mail: info@windpower-aachen.de
 www.windpower-aachen.de
 Drivetrains of wind turbines are subject to complex loads. We are driven by the need to identify these loads and take them into account in the design process before a wind turbine goes into operation.



enovation GmbH
 Strasse am Zeltplatz 7, 18230 Ostseebad Rerik
 Tel.: +49 (0)381 203792-190
 Fax: +49 (0)381 203792-101
 E-Mail: Stefan.bockholt@eno-vation.com
 www.eno-vation.com
 Your address for German engineer know-how, consulting and WEA licenses



Windrad Engineering GmbH
 Kröpeliner Strasse 4, 18209 Bad Doberan
 Tel.: +49 (0)38203 77630
 Fax: +49 (0)38203 77620
 E-Mail: mail@windrad-online.de
 www.windrad-online.de
 Windrad Engineering offers independent engineering services for Onshore and Offshore since 2002: complete design of a wind turbine, simulation, analyses, optimization and consulting.

Human resource services



AllCon Service & Dienstleistungs GmbH
 Gotenstr. 4, 20097 Hamburg
 Tel.: +49 (0)40 238848-0
 Fax: +49 (0)40 238848-48
 E-Mail: info@allcon.eu
 www.allcon.eu

Established in Wind for over 15 years, certified to SCP and DIN ISO 9001 we assist you in maintaining and erecting wind turbines. Both onshore and offshore. Around the world using service technicians.

Media & communication



new energy
 Neustädtische Kirchstrasse 6, 10117 Berlin
 Tel.: +49 (0)30 212341-141
 E-Mail: service@newenergy.info
 www.newenergy.info
 new energy is the magazine for those interested in energy policy. It is read by the entire renewables sector.



Nölting GmbH – AGENTUR für Unternehmenskommunikation
 Gottesweg 127, 50939 Köln
 Tel.: +49 (0)221 8461216-0
 Fax: +49 (0)221 8461216-71
 E-Mail: info@noelting.gmbh
 www.noelting.gmbh
 Nölting GmbH is one of the premier strategic communication agencies in the German windpower industry. In concert with Nölting Network, we deliver customized communication and distribution solutions for leading companies: We help wind our customers in the on- and offshore industry to establish a lasting presence or increase their market penetration.



Software solutions



AURELO business IT-solutions GmbH

Fraunhoferstr. 13 (Wissenschaftspark), 24118 Kiel
Tel.: +49 (0)431 530200-0
Fax: +49 (0)431 530200-999
E-Mail: info@aurelo.de
www.aurelo.de
ERP-software (based on MS Dynamics NAV) for project-planning and operating companies: commercial management, contracts, projects, finance/controlling, fund management, CRM (contacts, tasks, documents)



Deutsche WindGuard

Bundesallee 67, 12161 Berlin
Tel.: +49 (0)30 223200-10
Fax: +49 (0)30 223200-24
E-Mail: systems@windguard.de
www.windguard.com
Wind farm management system WONDER for technical management: data acquisition, data analysis, lifecycle record, control centre, watchdog, reporting, support for direct marketing and feed-in management.



EMD Deutschland GbR
www.emd.dk

EMD Deutschland GbR

Breitscheidstr. 6, 34119 Kassel
Tel.: +49 (0)561 31059-60
Fax: +49 (0)561 31059-69
E-Mail: emd-de@emd.dk
www.emd.dk

Modular software for the planning, design and simulation of wind energy projects (windPRO) and decentralized energy projects (energyPRO). Online performance monitoring for wind farms (windOPS).



fos4X GmbH

Thalkirchner Strasse 210, 81371 München
Tel.: +49 (0)89 999542-00
Fax: +49 (0)89 999542-01
E-Mail: info@fos4x.de
www.fos4x.de
fos4X entwickelt innovative IIoT- und Edge-Computing-Lösungen zur Kostensenkung und Effizienzsteigerungen der Windindustrie auf Basis seiner zuverlässigen Messtechnik.



TRICON Assets GmbH

Kerkstiege 28, 48268 Greven
Tel.: +49 (0)2571 5836450
Fax: +49 (0)2571 5836389
E-Mail: info@tricon-assets.de
www.tricon-assets.de
Software for technical and commercial plant management and for financial, system, project and contract management. All in One. TRIAss - WT

green[=]match Trade fairs & conferences for the wind energy industry

Greenmatch AG

Hebelstrasse 52, 4056 Basel
Tel.: +41 (0)613 0150 00
E-Mail: info@greenmatch.ch
www.greenmatch.ch
Software for financial modelling of renewable energies – value the cash flows of your projects reliably and keep track of their financial performance during operations.



M.O.S.S. Computer Grafik Systeme GmbH

Hohenbrunner Weg 13, 82024 Taufkirchen
Tel.: +49 (0)89 66675-100
Fax: +49 (0)89 66675-180
E-Mail: info@moss.de
www.moss.de

M.O.S.S. offers planning application services, as well as integration solutions and consulting services with respect to optimizing the processes of planning wind farms (WPPA).



SCADA International Deutschland GmbH

Kapstadtring 7, 2.OG, 22297 Hamburg
Tel.: +49 (0)40 22691442
E-Mail: frr@scada-international.com
www.scada-international.com
Supplier of 1st & 2nd Level SCADA-Solutions, parc control and Hardware-Solutions. Service as SCADA-Consulting and Performance-Optimization as well as onsite Installation of SCADA-Systems.



Deutsche Messe AG

Messegelände, 30521 Hannover
Tel.: +49 (0)511 89-34116
Fax: +49 (0)511 89-31122
E-Mail: marius.westenfeld@messe.de
www.messe.de

Deutsche Messe AG is a well-known organiser of investment goods trade fairs. The company was founded in 1947. With 1,155 employees Deutsche Messe AG is one of the worlds leading trade fair organisers.



Hamburg Messe und Congress GmbH

Messeplatz 1, 20357 Hamburg
Tel.: +49 (0)40 3569-2263
Fax: +49 (0)40 3569-692263
E-Mail: andreas.arnheim@hamburg-messe.de
www.windenergyhamburg.com/en
The world's leading expo for wind energy.



Messe Husum & Congress GmbH & Co. KG

Am Messeplatz 12-18, 25813 Husum
Tel.: +49 (0)4841 902-0
Fax: +49 (0)4841 902-246
E-Mail: info@husumwind.com
www.husumwind.com
From 10-13 September, HUSUM Wind, the wind industry's leading national trade fair, is showing what will define the industry in the future.



Manufacturer and supplier advisory board



Expert consulting advisory board



Investors' advisory board



Expert consulting advisory board



Scientific advisory board



Operators' advisory board

Planning

Grids & grid connection



Deutsche Windtechnik Umspannwerke GmbH

Kiellinie 84, 24105 Kiel
 Tel.: +49 (0)4347 71300-0
 Fax: +49 (0)4347 71300-13
 E-Mail: info-uw@deutsche-windtechnik.com
 www.deutsche-windtechnik.com
 Monitoring, fault elimination, operating +
 controlling, servicing, inspections, repair and
 management of substations.



Moeller & Poeller Engineering GmbH (M.P.E.)

Europaplatz 5, 72072 Tübingen
 Tel.: +49 (0)7071 138790
 E-Mail: info@moellerpoeller.de
 www.moellerpoeller.de
 Grid connection for on and offshore wind and PV
 farms. Planning for substations. Power system
 studies.



Netze BW GmbH

Schelmenwasenstrasse 15, 70567 Stuttgart
 Tel.: +49 (0)711 289-46000
 Fax: +49 (0)711 289-46765
 E-Mail: dienstleistungen-hs@netze-bw.de
 www.netze-bw.de/dienstleistungen
 From engineering and approval planning to the
 construction of a turnkey transformer station, Netze
 BW ensures wind farms feed into the 110kV grid
 efficiently.



SCADA International Deutschland GmbH

Kapstadtring 7, 2.OG, 22297 Hamburg
 Tel.: +49 (0)40 2269 1442
 E-Mail: frr@scada-international.com
 www.scada-international.com
 Supplier of 1st & 2nd Level SCADA-Solutions,
 parc control and Hardware-Solutions. Service as
 SCADA-Consulting and Performance-Optimization
 as well as onsite Installation of SCADA-Systems.

Ramboll

Chilehaus C – Burchardstrasse 13, 20097 Hamburg
 Tel.: +49 (0)40 302020-132
 Fax: +49 (0)40 302020-199
 E-Mail: info@ramboll.de
 www.ramboll.de
 As a full-service provider, Ramboll supports wind
 projects of all kinds. We are part of one of the
 world's leading consulting companies and are able
 to combine global know-how with local expertise.



WT Energiesysteme GmbH

Uttmannstrasse 15, 01591 Riesa
 Tel.: +49 (0)3525 51328-0
 Fax: +49 (0)3525 51328-20
 E-Mail: info@wt-energiesysteme.de
 www.wt-energiesysteme.de
 WTE has successfully been building numerous
 electrotechnical facilities for 15+ years. We have
 specialized in planning, building, maintaining and
 modernizing substations.

REETEC GmbH

Konsul-Smidt-Str. 71, 28217 Bremen
 Tel.: +49 (0)421 39987-0
 Fax: +49 (0)421 39987-11
 E-Mail: info@reetec.eu
 www.reetec.eu
 Offshore: mechanical & electrical assembly, opera-
 tion & maintenance, O&M concepts, engineering,
 obstruction marking, construction supervision,
 major component replacement & repair

Offshore



Agentur für Wirtschaftsförderung Cuxhaven

Kapitän-Alexander Str. 1, 27472 Cuxhaven
 Tel.: +49 (0)4721 59970
 Fax: +49 (0)4721 599720
 E-Mail: info@afw-cuxhaven.de
 www.afw-cuxhaven.de
 The development and marketing of the German
 Offshore Base Cuxhaven is one of the core tasks of
 the Economic Development Agency Cuxhaven.



Sika Deutschland GmbH

Rieter Tal, 71665 Vaihingen/Enz
 Tel.: +49 (0)7042 109-208
 Fax: +49 (0)7042 109-5102
 E-Mail: fries.achim@de.sika.com
 www.sika.de
 Protective coatings for wind turbines on- and offshore.



Deutsche WindGuard Offshore GmbH

Oldenburger Str. 65, 26316 Varel
 Tel.: +49 (0)4451 9515-0
 Fax: +49 (0)4451 9515-29
 E-Mail: info@windguard.de
 www.windguard.com
 Technical due diligence, onshore and offshore plan-
 ning, wind turbine continued operation, offshore
 design, production and construction supervision,
 service and logistics concepts.



Tractebel Engineering GmbH

Friedberger Str. 173, 61118 Bad Vilbel
 Tel.: +49 (0)6101 55-1445
 Fax: +49 (0)6101 55-1826
 E-Mail: info-de@tractebel.engie.com
 www.tractebel-engie.com/en/
 solutions/energy#renewables
 Tractebel Engineering GmbH offers world-wide
 planning and consulting services for onshore
 and offshore wind farm projects as well as wind
 expertises according to ISO 17025.





TÜV SÜD Industrie Service GmbH
Heidenkampsweg 51, 20097 Hamburg
Tel.: +49 (0)40 840521-411
Fax: +49 (0)40 840521-450
E-Mail: offshore@tuev-sued.de
www.tuev-sued.de/windenergy
Offshore wind power: Certification, inspection, surveillance. Project certification, type certification, site assessment, approval & periodic inspection on turbine, lifting equipment, service lift



Industrie Service



ABO Wind AG
Unter den Eichen 7, 65195 Wiesbaden
Tel.: +49 (0)611 26765-0
Fax: +49 (0)611 26765-599
E-Mail: kontakt@abo-wind.de
www.abo-wind.de
ABO Wind acquires, plans, finances and builds turnkey wind energy projects. In addition, ABO Wind sells project rights or collaborates with other developers to help their projects succeed.



BMR energy solutions GmbH
Berliner Ring 11, 52511 Geilenkirchen
Tel.: +49 (0)2451 91441-0
Fax: +49 (0)2451 91441-29
E-Mail: info@bmr-energy.com
www.bmr-energy.com
Wind energy – photovoltaics – bioenergy – consultancy – planning – financing – implementation



WIND-consult GmbH
Reuterstrasse 9, 18211 Bargeshagen
Tel.: +49 (0)38203 507-25
Fax: +49 (0)38203 507-23
E-Mail: company@wind-consult.de
www.wind-consult.de
Offshore – Meteorological Measurements on Offshore Research Platform FINO 2, Measurements on WT, Site Assessments-Wind and Energy Yield



ALTUS AG
Kleinoberfeld 5, 76135 Karlsruhe
Tel.: +49 (0)721 626906-0
Fax: +49 (0)721 626906-108
E-Mail: info@altus-ag.de
www.altus-ag.de/en/
As a project developer, we work with you all the way, from planning wind power and PV installations, to operating them. With years of expertise, we are a reliable partner for local authorities and participants in private projects.

Dr. Augustin Planungsbüro für Umwelttechnik
Strassenbahnring 13, 20251 Hamburg
Tel.: +49 (0)40 454681
Fax: +49 (0)40 454691
E-Mail: info@augustin-windenergie.de
www.augustin-windenergie.de
Planning and development of wind farms, planning permission, immission protection, land use planning, EIA, advice, financing



Planners & project developers



3Energy Unternehmensgruppe
Am Steinberg 7, 09603 Großschirma
Tel.: +49 (0)37328 898-0
Fax: +49 (0)37328 898-299
E-Mail: info@3energy.eu
www.3energy.eu
Tailored solutions in the field of sustainable and local energy generation and supply. From a single source – under one roof.



BayWa r.e. renewable energy GmbH
Herzog-Heinrich-Strasse 9, 80336 Munich
Tel.: +49 (0)89 383932-0
Fax: +49 (0)89 383932-32
E-Mail: info@baywa-re.com
www.baywa-re.com
Project development & turnkey construction, technical & commercial management, energy trading, rotor blade service, planning & consulting



Dunoair Windpark Planung GmbH
Hawstrasse 2a, 54290 Trier
Tel.: +49 (0)651 999889-13
E-Mail: c.wuertz@dunoair.com
www.dunoair.com/en
As a specialist for the planning, construction and management of sites for wind power plants in Germany and abroad, we promote climate and environmental protection.



ABICON GmbH
Schönsteiner Strasse 23, 34630 Gilserberg-Moisscheid
Tel.: +49 (0)6696 912939-10
Fax: +49 (0)6696 912939-20
E-Mail: info@abicon-gmbh.de
www.abicon-gmbh.de
As an innovative project developer for renewable energies you will benefit from our expertise in everything from planning to operational management in the wind energy, photovoltaics and biogas sectors.



BayWa r.e. Wind GmbH
Arabellastrasse 4, 81925 Munich
Tel.: +49 (0)89 383932-52
Fax: +49 (0)89 383932-171
E-Mail: wind@baywa-re.com
www.baywa-re.com
Full range of services for wind projects, planning projects from greenfield site to completion. Represented by the BayWa r.e. group network in Europe and the US.



EDF EN Deutschland GmbH
Friedrich-Ebert-Str. 38-40, 25421 Pinneberg
Tel.: +49 (0)4101 408890
Fax: +49 (0)4101 408891
E-Mail: info@edf-re.de
www.edf-re.de
Planning, realisation, construction, repowering, operational management and administration of wind farms.



Manufacturer and supplier advisory board



Expert consulting advisory board



Investors' advisory board



Expert consulting advisory board



Scientific advisory board



Operators' advisory board



EFI Wind GmbH

Lemförder Str. 80, 32369 Rahden-Sielhorst
 Tel.: +49 (0)208 377397-0
 Fax: +49 (0)208 377397-69
 E-Mail: info@efiwind.de
 www.efiwind.de
 Planning and development of wind farms, closing of land lease contracts, financing (dept + equity), turn-key construction, sale, management, consultancy.



EnerVest Deutschland GmbH

Maximilianstrasse 47, 80538 Munich
 Tel.: +49 (0)89 23239293-0
 Fax: +49 (0)89 23239293-49
 E-Mail: contact@enervest.eu
 www.enervest.eu
 As an investment company EnerVest AG is installing wind parks in Europe, and in particular in Germany.



EWS Consulting GmbH

Katztal 37, 5222 Munderfing
 Tel.: +43 (0)7744 20141
 Fax: +43 (0)7744 20141-41
 E-Mail: office@ews-consulting.at
 www.ews-consulting.com
 Feasibility studies, techn. planning, biol. & ecol. expertise, support permit process, constr. & operation management, repowering, due diligence, accred. testing center



Energieallianz Bayern GmbH & Co. KG

Ludwigstr. 47, 85399 Hallbergmoos
 Tel.: +49 (0)811 88991-600
 Fax: +49 (0)811 88991-615
 E-Mail: info@energieallianz-bayern.de
 www.energieallianz-bayern.de
 www.energieallianz-projekt.de
 Energieallianz Bayern plans, builds and operates wind turbines throughout Germany.



enosite GmbH

Strasse am Zeltplatz 7, 18230 Ostseebad Rerik
 Tel.: +49 (0)38296 746227
 Fax: +49 (0)381 203792-101
 E-Mail: jacqueline.wuensch@eno-site.com
 www.eno-site.com
 Services ranging from expert opinions to complex approval procedures are part of our portfolio. Many years of experience and expertise ensure first-class, manufacturer-independent support.

FICHTNER

Fichtner GmbH & Co. KG

Sarweystrasse 3, 70191 Stuttgart
 Tel.: +49 (0)711 8995-0
 Fax: +49 (0)711 8995-459
 E-Mail: info@fichtner.de
 www.fichtner.de
 Fichtner is Germany's biggest independent engineering and consultancy enterprise for infrastructure projects in the sectors of energy, water, environment, traffic engineering, and IT.



Energiequelle GmbH

Hauptstrasse 44, 15806 Zossen OT Kallinchen
 Tel.: +49 (0)33769 871 100
 E-Mail: info@energiequelle.de
 www.energiequelle.de
 Project planning, construction and operation of wind, biogas and PV power plants as well as storage facilities, transformer stations and planning innovative energy concepts.



envia THERM GmbH

Niels-Bohr-Strasse 2, 06749 Bitterfeld-Wolfen
 Tel.: +49 (0)3493 5167-0
 Fax: +49 (0)3493 5167-4402
 E-Mail: info@envia-therm.de
 www.envia-therm.de
 As a reliable and service-strong partner for wind energy projects, the company covers all services from project development to construction, repowering and operational management.



GAIA mbH

Jahnstr. 28, 67245 Lamsbheim
 Tel.: +49 (0)6233 359440-0
 Fax: +49 (0)6233 359440-1
 E-Mail: info@gaia-mbh.de
 www.gaia-mbh.de
 Your professional partner for planning, development, project coordination and storage solutions; servicing and technical management of wind turbines and photovoltaic systems as well as co-gen plants.



ENERTRAG AG

Gut Dauerthal, 17291 Dauerthal
 Tel.: +49 (0)39854 6459-0
 Fax: +49 (0)39854 6459 410
 E-Mail: enertrag@enertrag.com
 www.enertrag.com
 ENERTRAG is an expert in the project management, financing, building & operation of wind turbines, and also in the design and development of energy storage solutions.



EWE ERNEUERBARE ENERGIEN GmbH

Donnerschweer Str. 22–26, 26123 Oldenburg
 Tel.: +49 (0)441 8034181
 Fax: +49 (0)441 8034195
 E-Mail: erneuerbare@ewe.de
 www.ewe-erneuerbare.de
 Wind is our passion – and has been for 30 years. We develop and implement wind farms, we ensure optimal operation and individual repowering and we bring a breath of fresh air to partnerships.



GELSENWASSER AG

Willy-Brandt-Allee 26, 45891 Gelsenkirchen
 Tel.: +49 (0)171 2988860
 E-Mail: stephan.dohe@gelsenwasser.de
 www.gelsenwasser.de/wind
 Rely on tried and tested all-round service that takes account of political, legal and technical demands. Careful planning and presence on site: The way to implement your wind energy project.



**GP JOULE GmbH**

Cecilienkoog 16, 25821 Reußenköge
Tel.: +49 (0)4671 6074-0
E-Mail: info@gp-joule.de
www.gp-joule.de

From green field to electricity and hydrogen station:
As an integrated project partner, GP JOULE plans and implements energy and operating concepts with added value.

**Jade NaturEnergie GmbH & Co. KG**

Kronacherstr. 41, 96052 Bamberg
Tel.: +49 (0)951 9649-777
Fax: +49 (0)951 9649-778
E-Mail: info@jadenaturenergie.de
www.jadenaturenergie.de

Jade NaturEnergie has been successfully planning and implementing projects in renewable energy for many years with the help of its experienced team.

**OSTWIND Erneuerbare Energien GmbH**

Gesandtenstr. 3, 93047 Regensburg
Tel.: +49 (0)941 59589-0
Fax: +49 (0)941 59589-90
E-Mail: info@ostwind.de
www.ostwind.de

OSTWIND has successfully installed and run wind farms for over 25 years. In Germany and Europe the medium-sized company has developed, built and connected up 572 turbines with a total capacity of 1,010 MW.

**ie-Renewables | Ingenieurbüro für Erneuerbare Energien**

Zuckerberg 9, 55276 Oppenheim
Tel.: +49 (0)6133 491498-0
Fax: +49 (0)6133 491498-3
E-Mail: info@ie-renewables.de
www.ie-renewables.de

Professional and comprehensive consultancy services: regional as well as international project development, Due Diligence, contract negotiation/ tendering, Repowering, Asset Management & more.

**juwi AG**

Energie-Allee 1, 55286 Wörrstadt
Tel.: +49 (0)6732 9657-0
Fax: +49 (0)6732 9657-7001
E-Mail: info@juwi.de
www.juwi.com

juwi is one of the leading specialists in wind and solar energy projects. We collaborate on many projects with regional project developers, energy suppliers and energy cooperatives.

**PIONEXT GmbH**

Gartenstraße 22, 55232 Alzey
Tel.: +49 (0)6731 405-0
E-Mail: info@pionext.de
www.pionext.de

Project development and repowering from A to Z – from designing the wind farm layout and the conclusion of land contracts to the construction and commissioning of the wind turbines.

**Ingenieurbüro Jan Teut**

Vielitzer Weg 12, 16835 Lindow/Mark
Tel.: +49 (0)30 5557447-0
Fax: +49 (0)30 5557447-99
E-Mail: info@teut.de
www.teut.de

Company group TEUT: planning, installation, operation and repowering of wind turbines since 1996

**Landwind-Gruppe**

Watenstedter Str. 11, 38384 Gevensleben
Tel.: +49 (0)5354 9906-0
Fax: +49 (0)5354 9906-109
E-Mail: info@landwind-gruppe.de
www.landwind-gruppe.de

Site acquisitions, approval planning / project development of wind farms with public involvement, financing, grid connections, management of wind turbines and transformer stations, direct marketing.

**PLANKon Ing.-Büro für Windenergieprojekte**

Blumenstr. 26, 26121 Oldenburg
Tel.: +49 (0)441 39034-0
Fax: +49 (0)441 39034-22
E-Mail: mail@plankon.de
www.plankon.de

Studies/consultancy for wind yield, noise, shadow, wind measurements, planning, accr. test laboratory acc. to DIN 17025, authority and approval tender design, construction supervision, due diligence.

**iTerra energy GmbH**

Alter Schlachthof, Gottfried-Arnold-Str. 1a,
35398 Gießen
Tel.: +49 (0)641 9446478-0
Fax: +49 (0)641 9446478-29
E-Mail: info@iterra-energy.de
www.iterra-energy.de

iTerra energy successfully implements wind farm projects in a cost and benefit-oriented manner and, based on many years of experience, is a solid and profitable partner for onshore wind farm projects.

**NOTUS energy**

Parkstrasse 1, 14469 Potsdam
Tel.: +49 (0)331 62043-40
Fax: +49 (0)331 62043-44
E-Mail: windkraft@notus.de
www.notus.de

The companies within the NOTUS energy Group are project development companies which cover the entire value chain from development to management of wind energy projects.

**PNE AG**

Peter-Henlein-Strasse 2–4, 27472 Cuxhaven
Tel.: +49 (0)4721 718-06
Fax: +49 (0)4721 718-200
E-Mail: info@pne-ag.com
www.pne-ag.com

Development, realisation, operation and management of wind farms – international, onshore and offshore.



Manufacturer and supplier advisory board



Expert consulting advisory board



Investors' advisory board



Expert consulting advisory board



Scientific advisory board



Operators' advisory board



Prowind GmbH

Lengericher Landstrasse 11b, 49078 Osnabrueck
 Tel.: +49 (0)541 60029-0
 Fax: +49 (0)541 60029-29
 E-Mail: info@prowind.com
 www.prowind.com
 Planning, development, construction and operation of regional renewable energy projects.



Rübsamen Windenergie GmbH

Osterholder Allee 2, 25421 Pinneberg
 Tel.: +49 (0)4101 6967945
 Fax: +49 (0)4101 8591444
 E-Mail: info@ruebsamen-windenergie.de
 www.ruebsamen-windenergie.de
 Project development, construction, repowering, operation and management of wind parks inclusive of citizen participation both nationally and internationally.



Volkswind GmbH

Gustav-Weisskopf-Str. 3, 27777 Ganderkesee
 Tel.: +49 (0)4222 94138-0
 Fax: +49 (0)4222 94138-99
 E-Mail: info@volkswind.de
 www.volkswind.de
 Production of clean and renewable onshore wind energy.



Ramboll

Munscheidstrasse 14, 45886 Gelsenkirchen
 Tel.: +49 (0)209 167255-0
 E-Mail: info@ramboll.de
 www.ramboll.de
 Ramboll provides expert planning, engineering and consulting services for the entire life cycle of onshore and offshore wind energy projects.



Sabowind GmbH

Frauensteiner Strasse 118, 09599 Freiberg
 Tel.: +49 (0)3731 2608-0
 Fax: +49 (0)3731 2608-26
 E-Mail: info@sabowind.de
 www.sabowind.de/en
 Full-line provider of onshore-wind energy projects in Germany and Poland. Planning, development, implementation, repowering as well as technical and commercial management of wind energy turbines.



VSB Gruppe

Schweizer Strasse 3a, 01069 Dresden
 Tel.: +49 (0)351 21183-400
 Fax: +49 (0)351 21183-44
 E-Mail: info@vsb.energy
 www.vsb.energy
 VSB Group provides complete wind energy and photovoltaics solutions: from project development and implementing, right up to operations management as well as maintenance and repairs.



REA GmbH Management

Wernersstr. 23, 52351 Düren
 Tel.: +49 (0)2421 972575-0
 Fax: +49 (0)2421 972575-13
 E-Mail: info@rea-dn.de
 www.rea-dn.de
 Consulting engineers specialising in the planning of wind energy and PV plants. Coordination of approval procedures, project implementation and plant operation. Specialists in community energy plants.



Tractebel Engineering GmbH

Friedberger Str. 173, 61118 Bad Vilbel
 Tel.: +49 (0)6101 55 - 1784
 Fax: +49 (0)6101 55 - 1826
 E-Mail: info-de@tractebel.engie.com
 www.tractebel-engie.com/en/solutions/energy#renewables
 Tractebel Engineering GmbH offers world-wide planning and consulting services for onshore and offshore wind farm projects as well as wind expertises according to ISO 17025.



WestWind Projektierungs GmbH & Co. KG

Brinkstrasse 25, 27245 Kirchdorf
 Tel.: +49 (0)4273 9339-0
 Fax: +49 (0)4273 9339-44
 E-Mail: webkontakt@w-wind.de
 www.w-wind.de
 Turnkey Projects (national and international), Construction Supervision, Finance and Repowering



RES Deutschland GmbH

Unter den Linden 26–30, 10117 Berlin
 Tel.: +49 (0)30 22056459-0
 Fax: +49 (0)30 22056459-99
 E-Mail: info.germany@res-group.com
 www.res-group.com
 The project developer RES (Renewable Energy Systems) has been active worldwide since 1982 as a partner for the development, design, construction and operation of renewable energy projects.



UKA – Umweltgerechte Kraftanlagen GmbH & Co. KG

Dr.-Eberle-Platz 1, 01662 Meißen
 Tel.: +49 (0)3521 728060
 E-Mail: zentrale@uka-gruppe.de
 www.uka-gruppe.de
 Project development of wind and solar parks: Selecting and securing a site, obtaining approval, financing, implementation, turnkey installation with grid connection, repowering, management, project acquisition and cooperation.



WindStrom Erneuerbare Energien GmbH & Co. KG

Am Torfstich 11, 31234 Edemissen
 Tel.: +49 (0)5176 9204-0
 Fax: +49 (0)5176 9204-10
 E-Mail: info@windstrom.de
 www.windstrom.de
 Project development, commercial project management, network connection, realisation, commercial operations management.





Windwärts Energie GmbH

Hanomaghof 1, 30449 Hanover
 Tel.: +49 (0)511 123573-0
 Fax: +49 (0)511 123573-190
 E-Mail: info@windwaerts.de
 www.windwaerts.de

Windwärts provides the entire spectrum of project development services from conceptualisation to the approvals and tendering processes. We focus on the states of Lower Saxony, Schleswig-Holstein and the Ostwestfalen-Lippe region.

OX2 Wind Deutschland GmbH

Baumwall 7, 20459 Hamburg
 Tel.: +49 (0)40 6963 9980-0
 Fax: +49 (0)40 6963 9980-9
 E-Mail: hamburg@ox2.com
 www.ox2.com/en/

OX2 Wind Deutschland GmbH offers an expertise within the entire value chain of wind power – from project development, through financing, sales and construction to technical and commercial management.



Sector Coupling



GP JOULE Projects GmbH & Co. KG

Cecilienkoog 16, 25821 Reußenköge
 Tel.: +49 (0)4671 6074-0
 E-Mail: info@gp-joule.de
 www.gp-joule.de

As an experienced project partner, system optimiser and all-round doer, we stand for seamless repowering projects. We bring a breath of fresh air for your added value.



WKN GmbH

Otto-Hahn-Strasse 12–16, 25813 Husum
 Tel.: +49 (0)4841 8944-100
 Fax: +49 (0)4841 8944-225
 E-Mail: info@wkn-group.com
 www.wkn-group.com

Planning, development, construction and operation of first-class wind energy projects.

Sabowind GmbH

Frauensteiner Strasse 118, 09599 Freiberg
 Tel.: +49 (0)3731 2608-0
 Fax: +49 (0)3731 2608-26
 E-Mail: info@sabowind.de
 www.sabowind.de/en

Replacement of old wind turbines by modern and more efficient ones, linked to the planning, development, implementation as well as the technical and commercial management of wind energy projects.

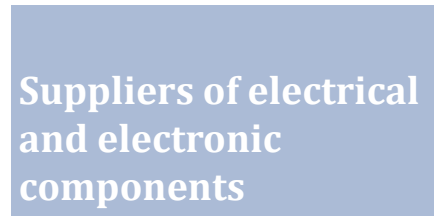

Aviation obstruction markers & lighting systems

Repowering



Deutsche Windtechnik Repowering GmbH & Co. KG

Stephanitorsbollwerk 1 (Haus LEE), 28217 Bremen
 Tel.: +49 (0)421 69105-0
 Fax: +49 (0)421 69105-299
 E-Mail: l.schiermeyer@deutsche-windtechnik.de
 www.deutsche-windtechnik.com

We offer all services related to repowering: buying and selling of turbines, dismantling, logistics, planning, refurbishment, storage.



Windwärts Energie GmbH

Hanomaghof 1, 30449 Hannover
 Tel.: +49 (0)511 123573-0
 Fax: +49 (0)511 123573-190
 E-Mail: info@windwaerts.de
 www.windwaerts.de

Windwärts provides tailored solutions for any repowering project – from assessing existing facilities and systems to project development to dismantling old and erecting new plant.

Lanthan GmbH & Co. KG

Jakobstrasse 25a, 28195 Bremen
 Tel.: +49 (0)421 696465-0
 E-Mail: info@lanthan.eu
 www.lanthan.eu

National und international Obstacle lightings, surface reduced lighting system ARC-SIRIL, and transponder aircraft detection systems for all manufacturers.



EnBW Energie Baden-Württemberg AG

Schelmenwasenstrasse 15, 70567 Stuttgart
 Tel.: +49 (0)711 289-48787
 E-Mail: windkraft@enbw.com
 www.enbw.com/nach-EEG

Purchase, dismantling, repowering, direct marketing: EnBW offers owners of existing wind farms a wide range of services from a single source in order to optimize the operating concept for the future.



Parasol GmbH & Co. KG

Sönke-Nissen-Koog 58, 25821 Reußenköge
 Tel.: +49 (0)4674 962920
 Fax: +49 (0)4674 827 9999
 E-Mail: kontakt@passivradar.de
 www.passivradar.de

Parasol in an aviation warning system – an affordable passive radar safety system which is considerate to both: local residents and wildlife.



Manufacturer and supplier advisory board



Expert consulting advisory board



Investors' advisory board



Expert consulting advisory board



Scientific advisory board



Operators' advisory board



QV LUX GmbH

Steindamm 21, 16928 Groß Pankow
Tel.: +49 (0)30 3512886-49
Fax: +49 (0)30 3512886-33
E-Mail: phboysen@qvlux.com
www.qvlux.com

QV LUX offers a radar-assisted system for the on-demand night lighting of wind farms – and it is the first such system in the world to be approved for ten-year regular operation.



REETEC GmbH

Konsul-Smidt-Str. 71, 28217 Bremen
Tel.: +49 (0)421 39987-0
Fax: +49 (0)421 39987-11
E-Mail: info@reetec.eu
www.reetec.eu

Onshore and Offshore – Turnkey solutions for wind farms: day and night marking, tower obstruction lights, visibility control, helicopter platform lighting, on-demand night-time marking

Condition monitoring systems



Bachmann Monitoring GmbH

Fritz-Bolland-Str. 7, 07407 Rudolstadt
Tel.: +49 (0)3672 3186-0
Fax: +49 (0)3672 3186-200
E-Mail: vertrieb-monitoring@bachmann.info
www.bachmann.info

Bachmann developed the world's first condition monitoring system integrated into the control systems of wind turbines. A team of specialist data analysts monitors the condition of about 6000 turbines, 80 different types.



GfM Gesellschaft für Maschinendiagnose mbH

Köpenicker Strasse 325, 12555 Berlin
Tel.: +49 (0)30 65762565
E-Mail: mailbox@maschinendiagnose.de
www.maschinendiagnose.de
Fully automatic Online Condition Monitoring System Peakalyzer | BladeBearingAnalyzer | BaseAnalyzer



Gram & Juhl A/S

Technologiepark 4, 26129 Oldenburg
Tel.: +49 (0)441 77931345
E-Mail: sales@gramjuhl.com
www.gramjuhl.com
Gram & Juhl is a world leading supplier of condition monitoring systems with close to 25,000 wind turbines embedded with the TCM® technology.



Schaeffler Monitoring Services GmbH

Kaiserstr. 100, 52134 Herzogenrath
Tel.: +49 (0)9721 9149-0
Fax: +49 (0)9721 9149-59
E-Mail: industrial-services@schaeffler.com
www.schaeffler.com/services

Schaeffler offers products and services for all aspects of condition monitoring. Thus maintenance operation costs can be reduced and the availability of wind turbines can be increased.



Weidmüller Monitoring Systems GmbH

Else-Sander-Str. 8, 01099 Dresden
Tel.: +49 (0)351 213916-50
E-Mail: monitoring.systems@weidmueller.com
www.weidmueller.com/bladecontrol

Your partner in Industrial Connectivity Operating wind turbines efficiently – optimum yield with our automation solutions



Wölfel Wind Systems GmbH

Max-Planck-Str. 15, 97204 Höchberg
Tel.: +49 (0)931 49708-0
Fax: +49 (0)931 49708-150
E-Mail: info@woelfel.de
www.woelfel.de

On- and offshore monitoring systems for foundations, towers and rotor blades for the monitoring of loads, damage and icing and for the optimization of harvesting and life cycle.

Controls, cables & switchgear cabinets



Beckhoff Automation GmbH & Co. KG

Wahmstr. 56, 23552 Lübeck
Tel.: +49 (0)451 203988-0
Fax: +49 (0)451 203988-20
E-Mail: wind@beckhoff.com
www.beckhoff.com/wind

More than 50,000 wind turbines all over the world have been automated using Beckhoff technology, each providing up to 8 MW capacity, including in regions with extreme climatic conditions.



Deutsche Windtechnik Steuerung GmbH & Co. KG

Osterport 2f, 25872 Ostensefeld
Tel.: +49 (0)4843 20448-200
Fax: +49 (0)4843 20448-299
E-Mail: info-str@deutsche-windtechnik.com
www.deutsche-windtechnik.com

Development of electronics in wind power plants, sales, servicing, optimization, reproductions, consultation.



HELUKABEL GmbH

Dieselstr. 8–12, 71282 Hemmingen
Tel.: +49 (0)7150 92090
Fax: +49 (0)7150 81786
E-Mail: info@helukabel.de
www.helukabel.de

Cables and wires for wind turbines: Wind power cables, control cables, power distribution cables, single conductors & computer data cables.



Kübler Group

Schubertstr. 47, 78054 Villingen-Schwenningen
Tel.: +49 (0)7720 39030
Fax: +49 (0)7720 21564
E-Mail: info@kuebler.com
www.kuebler.com/windenergy

The Kübler Group belongs today to the leading specialists worldwide in the fields of position and motion sensors, functional safety, counting and process technology and transmission technology.





Nidec SSB Wind Systems GmbH

Neuenkirchener Strasse 13, 48499 Salzbergen
 Tel.: +49 (0)5976 946-0
 Fax: +49 (0)5976 946-139
 E-Mail: info.ssb@mail.nidec.com
 www.ssbwindsystems.com
 SSB Wind Systems is your partner for:
 - Pitch systems (750 kW to 10 MW)
 - Switch and control cabinets
 - Service (training, support)
 - One-stop shop: multivendor capability for all accessories and spare parts for all electrical pitch systems



OAT GmbH

August-Thyssen-Str. 7, 32278 Kirchlengern
 Tel.: +49 (0)5223 18309-0
 Fax: +49 (0)5223 18309-15
 E-Mail: info@oat-gmbh.com
 www.oat-gmbh.com
 Development, manufacturing and sales of pitch systems for wind turbines 0,5 - 10 MW. Pitchsystems as complete package or delivery of key-main-parts.



Prysmian Kabel und Systeme GmbH

Alt Moabit 91 D, 10559 Berlin
 Tel.: +49 (0)30 36754-0
 Fax: +49 (0)30 36754-571
 E-Mail: kontakt@prysmiangroup.com
 www.prysmiangroup.com
 Prysmian Group is world leader in the energy and telecom cable systems industry: almost 140 years of experience, sales exceeding €11 billion, about 30,000 employees in over 50 countries and 112 plants.



Rittal GmbH & Co. KG

Auf dem Stützelberg, 35745 Herborn
 Tel.: +49 (0)2772 505-1344
 Fax: +49 (0)2772 505-17344
 E-Mail: heun.m@rittal.de
 www.rittal.com
 Rittal GmbH & Co. KG is the world's leading supplier of control cabinets, power distribution, air conditioning, IT infrastructure and software & service for the protection and safe operation of electrical systems.



SCADA International Deutschland GmbH

Kapstadtring 7, 2.OG, 22297 Hamburg
 Tel.: +49 (0)40 22691442
 E-Mail: frr@scada-international.com
 www.scada-international.com
 Supplier of 1st & 2nd Level SCADA-Solutions, parc control and Hardware-Solutions. Service as SCADA-Consulting and Performance-Optimization as well as onsite Installation of SCADA-Systems.



LAPP (U.I. Lapp GmbH)

Schulze-Delitzsch-Strasse 25, 70565 Stuttgart
 Tel.: +49 (0)711 7838-3175
 Fax: +49 (0)711 7838-7330
 E-Mail: andreas.mueller@lappkabel.de
 www.lappgroup.com www.lappkabel.com
 The Stuttgart-based Lapp Group is a leading supplier of integrated solutions and branded products for cable and connection technology.



Weidmüller GmbH & Co. KG

Klingenbergstrasse 16, 32758 Detmold
 Tel.: +49 (0)5231 1428-0
 Fax: +49 (0)5231 1428-116
 E-Mail: weidmueller@weidmueller.de
 www.weidmueller.com
 Wind energy Operating wind turbines efficiently – optimum yield with our automation solutions



Wieland Electric GmbH

Brennerstrasse 10–14, 96052 Bamberg
 Tel.: +49 (0)951 9324-0
 Fax: +49 (0)951 9324-198
 E-Mail: info@wieland-electric.com
 www.wieland-electric.com
 Wieland supplies electrical engineering system solutions for lighting, power distribution and safety technology in wind turbines.

Cooling & climatisation



ELMEKO GmbH + Co. KG

Graf-Zeppelin-Strasse 5, 56479 Liebenscheid
 Tel.: +49 (0)2736 509748-0
 Fax: +49 (0)2736 509748-30
 E-Mail: info@elmeko.de
 www.elmeko.de
 ELMEKO manufactures and distributes innovative premium components made in Germany for switchgear cabinet air-conditioning, lighting and accessories.



STEGO Elektrotechnik GmbH

Kolpingstrasse 21, 74523 Schwaebisch Hall
 Tel.: +49 (0)791 95058-0
 Fax: +49 (0)791 95058-45
 E-Mail: info@stego.de
 www.stego.de
 Enclosure Climatisation. Perfect. STEGO heating elements, regulators, fans, lamps and accessories protect your sensitive electronic components against harmful climatic influences.



Manufacturer and supplier advisory board



Expert consulting advisory board



Investors' advisory board



Expert consulting advisory board



Scientific advisory board



Operators' advisory board

Energy & data transmission



Schneider Electric GmbH

Steinheimer Strasse 117, 63500 Seligenstadt
 Tel.: +49 (0)6182 811135
 Fax: +49 (0)6182 811644
 E-Mail: achim.kreith@schneider-electric.com
 www.schneider-electric.com
 Smart Wind energy solutions for a sustainable future. Effective solutions for wind farm safety and best practices. Our technologies ensure that Life Is On everywhere, for everyone and at every moment.



Schunk Carbon Technology

Rodheimer Strasse 59, 35452 Heuchelheim
 Tel.: +49 (0)5138 617892
 E-Mail: frank.knittler@schunk-group.com
 www.schunk-carbontechnology.com/en
 Schunk Carbon Technology is an international market leader in technology and material applications for mechanical and electrical carbon, thermal carbon and technical ceramics.



Weitkowitz GmbH

Woltorfer Strasse 125, 31224 Peine
 Tel.: +49 (0)5171 70610
 E-Mail: info@weitkowitz.de
 www.weitkowitz.de
 Weitkowitz has been manufacturing and supplying cable terminals, connectors, ferrules, cable ties, mechanical and hydraulic pressing and cutting tools for over 100 years. We'd be glad to collaborate with you to develop special wind energy solutions.

Generators



Elin Motoren GmbH

Elin-Motoren-Str. 1, 8160 Weiz
 Tel.: +43 (0)3172 90606-1000
 E-Mail: contact@elinmotoren.at
 www.elinmotoren.at/en
 Elin Motoren GmbH develops, produces and sells wind turbine generators based on various customer specific technical designs with a power range of 750 kW to currently 8,600 kW.



Ammonit Wind Tunnel GmbH

Reuterstrasse 13, 18211 Bargeshagen
 Tel.: +49 (0)38203 507-50
 Fax: +49 (0)38203 507-23
 E-Mail: info@ammonit-windtunnel.com
 www.ammonit-windtunnel.com
 DAkkS accredited calibration laboratory, Calibration of anemometer (Cup and Ultrasonic) according to MEASNET and IEC 61400-12-1, Calibration of Wind Vane



anemos-jacob GmbH

Oldershäuser Hauptstrasse 22, 21436 Oldershäusen
 Tel.: +49 (0)4133 21069-6
 E-Mail: wind@anemos-jacob.de
 wind@anemos-jacob.de
 Selling and renting of IEC-compliant, classified Sodar-instruments

Measurement equipment & measuring masts



AL-PRO GmbH & Co. KG

Dorfstrasse 100, 26532 Großheide
 Tel.: +49 (0)4936 69860
 E-Mail: info@al-pro.de
 www.al-pro.de
 LIDAR is a key technology for detailed wind profiling up to a height of 200 m. AL-PRO offers accredited LIDAR wind measurements with own devices: from the verification, the measurement campaign to the wind study you can profit of our accredited services.

Deutsche WindGuard

Oldenburger Str. 65, 26316 Varel
 Tel.: +49 (0)4451 9515-0
 Fax: +49 (0)4451 9515-29
 E-Mail: info@windguard.de
 www.windguard.com
 Anemometer and wind vane calibration, calibration of LiDAR/SODAR, wind measurement systems sale, rotor blade profile measurement in an acoustically optimized wind tunnel, icing wind tunnel



Ammonit Measurement GmbH

Wrangelstrasse 100, 10997 Berlin
 Tel.: +49 (0)30 6003188-0
 Fax: +49 (0)30 6003188-10
 E-Mail: info@ammonit.com
 www.ammonit.com
 Wind / solar measurement systems for site assessment, wind / solar power plant monitoring, power curve measurement, data loggers, meteorological sensors, LiDARs, SoDARs and a web monitoring platform.

GWU-Umweltechnik GmbH

Bonner Ring 9, 50374 Erftstadt
 Tel.: +49 (0)2235 95522-0
 Fax: +49 (0)2235 95522-99
 E-Mail: lidar@gwu-mail.de
 www.lidar-world.de
 Sensors and systems for wind and wind profile measuring, mobile and stationary Doppler wind LiDAR systems on various platforms: land-based, nacelle-based, floating and airborne.



**METEK Meteorologische Messtechnik GmbH**

Fritz-Strassmann-Str. 4, 25337 Elmshorn

Tel.: +49 (0)4121 43590

Fax: +49 (0)4121 435920

E-Mail: info@metek.de

www.metek.de

Sensors and profilers for wind-/turbulence measurements: Doppler Sodar PCS.2000, Doppler Lidar Stream Line and Wind Scout/Wind Ranger, ultrasonic anemometer uSonic, data logger mLog, rental service.

**Siemens AG**

Gleiwitzer Str. 555, 90475 Nuremberg

E-Mail: wind-equipment.industry@siemens.com

www.siemens.com/wind-equipment

Creating the most from wind. Maximum performance and efficiency for wind turbines and wind farms with Wind Equipment from Siemens.

**JUMO GmbH & Co. KG**

Moritz-Juchheim-Str. 1, 36039 Fulda

Tel.: +49 (0)661 6003-0

Fax: +49 (0)661 6003-500

E-Mail: mail@jumo.net

www.jumo.net

The JUMO product range includes the entire measuring chain from sensors to automation solutions for temperature, pressure, liquid analysis, flow rate, filling level and humidity.

Sensors**MTS Sensor Technologie GmbH & Co. KG**

Auf dem Schüffel 9, 58513 Lüdenscheid

Tel.: +49 (0)2351 95870

Fax: +49 (0)2351 56491

E-Mail: info.de@mtssensors.com

www.mtssensors.com

MTS Sensors is a global leader in sensing technologies and solutions that enable feedback control automation and safety applications.

**Balluff GmbH**

Schurwaldstr. 9, 73765 Neuhausen

Tel.: +49 (0)7158 173-0

Fax: +49 (0)7158 5010

E-Mail: bernd.schneider@balluff.de

www.balluff.com

Sensor and automation solutions for the wind turbine and its manufacture

**Kübler Group**

Schubertstr. 47, 78054 Villingen-Schwenningen

Tel.: +49 (0)7720 39030

Fax: +49 (0)7720 21564

E-Mail: info@kuebler.com

www.kuebler.com/safety

The Kübler Group belongs today to the leading specialists worldwide in the fields of position and motion sensors, functional safety, counting and process technology and transmission technology.

Safety features & equipment**SHE Solution Bergmann GmbH & Co. KG**

Im Sundernkamp 2, 32130 Enger

Tel.: +49 (0)5224 9393850

Fax: +49 (0)5224 9393852

E-Mail: info@she-solution.de

www.she-solution.de

SHE Solution offers comprehensive solutions for the protection and safety at work. Our quality services range from providing convincing technical solutions to full-service. Taste the difference!

**Barksdale GmbH**

Dorn-Assenheimer Str. 27, 61203 Reichelsheim

Tel.: +49 (0)6035 949-0

Fax: +49 (0)6035 949-111

E-Mail: info@barksdale.de

www.barksdale.de

For over 60 years Barksdale has been developing and distributing state-of-the-art solutions for the mechanical and electronic control of pressure, level, flow and temperature.

Transformers, converters & power resistors**Isoblock Schaltanlagen GmbH & Co. KG**

Anton-Storch-Str. 17, 49080 Osnabrück

Tel.: +49 (0)541 95909-71

Fax: +49 (0)541 95909-50

E-Mail: peter.schriewer@isoblock.de

www.isoblock.de

Planning, production, installation, commissioning & service of medium and low voltage plants, transmission stations up to 36 kV, state-of-the-art grid protection and telecontrol, all with full service

**SICK AG**

Erwin-Sick-Str. 1, 79183 Waldkirch

Tel.: +49 (0)7681 202-0

Fax: +49 (0)7681 202-3863

E-Mail: info@sick.de

www.sick.de

SICK is a leading manufacturer of intelligent sensors and sensor solutions for factory, logistics and process automation.

**eologix sensor technology gmbh**

Kratkystrasse 2, 8020 Graz

Tel.: +43 (0)316 931215-100

E-Mail: office@eologix.com

www.eologix.com

Wireless ice detection and temperature measurement for wind turbine rotor blades. eologix provides an easily retrofittable sensor system for all types of wind turbines.

**Liebherr-Components AG**

Kirchweg 46, 5415 Nussbaumen AG/Switzerland

Tel.: +41 (0)56 296-4300

Fax: +41 (0)56 296-4301

E-Mail: components@liebherr.com

www.liebherr.com/components

Frequency converters for wind turbines with a power range from 2 MW to 5 MW.



Manufacturer and supplier advisory board



Expert consulting advisory board



Investors' advisory board



Expert consulting advisory board



Scientific advisory board



Operators' advisory board

Suppliers of large components

Foundations & footings



DAFA Deutschland GmbH

Am Oxer 7, 24955 Harrislee
Tel.: +49 (0)461 57498536
Fax: +49 (0)461 574985369
E-Mail: info@dafa-germany.de
www.dafa-as.com

DAFA Tower Foundation System: Formwork elements that precisely match requirements guarantee low tolerances and safe processes on the construction site.



EEW Special Pipe Constructions GmbH

Am Eisenwerk 1, 18147 Rostock
Tel.: +49 (0)381 81716-0
Fax: +49 (0)381 81716-110
E-Mail: info@eewspc.de
www.eewspc.de

Foundation pipes & pipe components for offshore wind / oil & gas: Monopiles/Transition pieces, Prefabricated components for jackets, Pin piles for jackets, Suction piles.



KTW Umweltschutztechnik GmbH

Magdalaer Str. 102a, 99441 Mellingen
Tel.: +49 (0)36453 8750
Fax: +49 (0)36453 87511
E-Mail: info@ktweimar.de
www.ktweimar.de

KTW Umweltschutztechnik GmbH provides foundations and towers with highly elastic seals and coatings, concrete repair and strengthening with life-tested products (even at high altitude, for example hybrid towers).



Peter Chr. Petersen GmbH & Co. KG

Marktstraat 31, 25842 Langenhorn
Tel.: +49 (0)4672 7740-0
Fax: +49 (0)4672 7740-77
E-Mail: info@pcpetersen.de
www.pcp-bau.de

More than 20 years of experience in the following fields: pile driving, excavation work, water drainage, reinforced concrete work, and construction planning for foundations.



LAP GmbH Laser Applikationen

Zeppelinstr. 23, 21337 Lueneburg
Tel.: +49 (0)4131 9511-95
Fax: +49 (0)4131 9511-96
E-Mail: info@lap-laser.com
www.lap-laser.com

LAP develops, manufactures and distributes laser-based projection systems for precise positioning. LAP CAD-PRO laser projectors are used worldwide for WEC rotor blade manufacturing.

Rotor blades & rotor blade materials



DAFA Deutschland GmbH

Am Oxer 7, 24955 Harrislee
Tel.: +49 (0)461 57498536
Fax: +49 (0)461 574985369
E-Mail: info@dafa-germany.de
www.dafa-as.com

DAFA RotaSeal® – Your best choice to protect rotating components in the turbine against penetration of salt, sand, water or dust. Use DAFA Rotaseal to meet demanding requirements for the hub or tower.



Towers

DAFA Deutschland GmbH

Am Oxer 7, 24955 Harrislee
Tel.: +49 (0)461 57498536
Fax: +49 (0)461 574985369
E-Mail: info@dafa-germany.de
www.dafa-as.com

Foam, rubber and plastic solutions – seal, absorb and protect. Our tower solutions ensure the safety of people and materials and make maintenance easier.



HAWART Sondermaschinenbau GmbH

Handwerksweg 8, 27777 Ganderkesee
Tel.: +49 (0)4222 94139-0
Fax: +49 (0)4222 94139-60
E-Mail: info@hawart.de
www.hawart.de

Development, design and production of manufacturing systems and logistics components for the wind energy industry.



Max Bögl Wind AG

PO Box 11 20, 92301 / 92369 Neumarkt i. d. Opf.
Tel.: +49 (0)9181 909-0
E-Mail: wind@max-boegl.de
www.mbrenewables.com

We are manufacturer of the world's highest hybrid towers and set new standards in the storage sector with our Water Battery. As a turnkey partner we offer an economical full-service package right through to the finished wind farm.



Ventur GmbH

Marienhütte 6, 57080 Siegen
Tel.: +49 (0)271 3189-290
Fax: +49 (0)271 3189-231
E-Mail: vertrieb-ventur@droessler.de
www.droessler-ventur.de

Development, production and installation of concrete towers for wind turbines. Simple and unrestricted due to a unique production, crane, transport and installation concept – available worldwide.



Suppliers of mechanical components

Access technology



goracon systemtechnik gmbh

Färbereistrasse 4, 48565 Steinfurt
Tel.: +49 (0)2552 9975-0
Fax: +49 (0)2552 9975-10
E-Mail: info@goracon.de
www.goracon.de

Service lifts, climbing aids, hoist technology, assembly platforms, blade lifts, After Sales Service.



Hailo Wind Systems GmbH & Co. KG

Kalteiche-Ring 18, 35708 Haiger
Tel.: +49 (0)2773 82-0
Fax: +49 (0)2773 82-1561
E-Mail: info@hailo-windsystems.com
www.hailo-windsystems.com

Hailo Wind Systems is one of the world's market and technology leaders for access solutions. Quality, reliability and safety always have top priority for our products, services and trainings.



Käuffer Befahrtechnik Gebr. GmbH

Mühlenberg 5, 42499 Hückeswagen
Tel.: +49 (0)2192 9203-20
Fax: +49 (0)2192 9203-33
E-Mail: d.kaeuffer@kaeuffer.de
www.kaeuffer.de

We offer manufacturing, delivery, assembling, service, maintenance of blade and tower access systems, offshore solutions – worldwide sale and rental with on-site service, inspection of service lifts.

Bearings

LIEBHERR

Liebherr-Components AG

Kirchweg 46, 5415 Nussbaumen AG/Switzerland
Tel.: +41 (0)56 29643-00
Fax: +41 (0)56 29643-01
E-Mail: components@liebherr.com
www.liebherr.com/bearings

With over 60 years of experience as a manufacturer of slewing bearings, Liebherr is a strong partner for the wind industry. Four-point-bearings and roller bearings with a diameter starting from 800 up to 7.500 mm.



NSK Deutschland GmbH

Harkortstrasse 15, 40880 Ratingen
Tel.: +49 (0)2102 481-0
E-Mail: info-de@nsk.com
www.nskeurope.com

NSK has been active in the field of wind energy for decades and is one of the main suppliers of gearboxes. Other focal points are bearings for main rotors and generators.

SCHAEFFLER

Schaeffler Technologies AG & Co. KG

Georg-Schäfer-Str. 30, 97421 Schweinfurt
Tel.: +49 (0)9721 91-0
Fax: +49 (0)9721 91-3435
E-Mail: info@schaeffler.com
www.schaeffler.de/windpower

Schaeffler is one of the world's leading bearing manufacturers. We produce solutions for the wind power sector ranging from individual bearings through to complete Industry 4.0 packages.



thyssenkrupp

thyssenkrupp rothe erde Germany GmbH

Tremoniastr. 5–11, 44137 Dortmund
Tel.: +49 (0)231 186-0
Fax: +49 (0)231 186-2500
E-Mail: rotheerde@thyssenkrupp.com
www.thyssenkrupp-rotheerde.com

Achieving greatness requires great work. thyssenkrupp rothe erde is the global market leader in slewing bearings and a leading producer of seamless rolled rings.

Bolts & fasteners



August Friedberg GmbH

Achternbergstr. 38, 45884 Gelsenkirchen
Tel.: +49 (0)209 9132-0
Fax: +49 (0)209 9132-178
E-Mail: info@august-friedberg.com
www.august-friedberg.com

Fasteners for wind turbines; HV tower bolt sets up to M72; Studs; Rotor blade connection systems; Application engineering and development partnership



HEICO Befestigungstechnik GmbH

Ensestrasse 1–9, 59469 Ense-Niederense
Tel.: +49 (0)2938 805-0
Fax: +49 (0)2938 805-198
E-Mail: sales@heico-group.com
www.HEICO-GROUP.com

Your expert for most demanding bolt connections. Over 100 years of experience and expertise in fastening technologies make HEICO a competent partner for the wind industry.



Schraubenwerk Zerst GmbH

Altbuchsland 22, 39261 Zerst
Tel.: +49 (0)3923 713-0
Fax: +49 (0)3923 713-200
E-Mail: info@schraubenwerk.com
www.schraubenwerk.de/index_en.html

Screw fasteners for wind turbines and their components, HV sets up to M72 size, standard and specially designed screws, rotor blade fasteners, global delivery for assembly and to construction sites.

Brakes



mayr power transmission

Eichenstr. 1, 87665 Mauerstetten

Tel.: +49 (0)8341 804-0

Fax: +49 (0)8341 421

E-Mail: info@mayr.com

www.mayr.com

Safety brakes for pitch/azimuth drives (yaw) in cold climate version (GL-certified up to -40°C), tower hoists, service lifts, lifting appliances, cranes, electromagnetic brakes for small wind turbines.



RENK AG

Rodder Damm 170, 48432 Rheine

Tel.: +49 (0)5971 790-269

Fax: +49 (0)5971 790-208

E-Mail: info.rheine@renk.biz

www.renk-ag.com

RENK enjoys a global reputation as a manufacturer of propulsion equipment. The product lineup includes multi-magawatt gear units with capacities starting from 5 MW, couplings and bearings.



Liebherr-Components AG

Kirchweg 46, 5415 Nussbaumen AG/Switzerland

Tel.: +41 (0)56 29643-00

Fax: +41 (0)56 29643-01

E-Mail: components@liebherr.com

www.liebherr.com/gearboxes

Liebherr develops high-performance yaw and pitch gearboxes for the wind industry. Planetary gearings: up to module 50 at the output pinion and 600 kNm output torque.

Coupling



CENTA Antriebe Kirschey GmbH

Bergische Strasse 7, 42781 Haan

Tel.: +49 (0)2129 912-0

Fax: +49 (0)2129 2790

E-Mail: centa@centa.de

www.centa.info

CENTA is part of Rexnord Industries. As a global leader in premium couplings, Rexnord provides the same high quality customer solutions and service you've come to expect from CENTA since 1970.



ABM Greiffenberger Antriebstechnik GmbH

Friedenfelser Str. 24, 95615 Marktredwitz

Tel.: +49 (0)9231 67-0

Fax: +49 (0)9231 67-5145

E-Mail: wind@abm-antriebe.de

www.abm-drives.com

Pitch motors in asynchronous technology for wind turbines of up to 3MW.



NGC Transmission Europe GmbH

Schifferstr. 196, 47059 Duisburg

Tel.: +49 (0)203 509600-0

Fax: +49 (0)203 509601-90

E-Mail: wind-eu@NGCtransmission.com

www.NGCtransmission.com

NGC – Your global partner for main gearboxes and pitch & yaw drives



RENK AG

Rodder Damm 170, 48432 Rheine

Tel.: +49 (0)5971 790-269

Fax: +49 (0)5971 790-208

E-Mail: info.rheine@renk.biz

www.renk-ag.com

RENK enjoys a global reputation as a manufacturer of propulsion equipment. The product lineup includes multi-magawatt gear units with capacities starting from 5 MW, couplings and bearings.



mayr power transmission

Eichenstr. 1, 87665 Mauerstetten

Tel.: +49 (0)8341 804-0

Fax: +49 (0)8341 421

E-Mail: info@mayr.com

www.mayr.com

Overload systems for wind turbine gearboxes; torque limiters for climbing aid drives in the tower; switchable clutches for the drives of maintenance platforms; large clutches for gearbox test stands.

Gears



BRAUER Maschinentechnik AG

Raiffeisenring 25, 46395 Bocholt

Tel.: +49 (0)2871 7033

Fax: +49 (0)2871 7036

E-Mail: j.brauer@brauer-getriebe.de

www.brauer-getriebe.de

Repair and improvement of wind turbine gearboxes of all types and in every size.



Stromag GmbH

Hansastraße 120, 59425 Unna

Tel.: +49 (0)2303 102-0

E-Mail: marco.niehnus@stromag.com

www.stromag.com

For more than 25 years Stromag has been an indispensable partner with an excellent reputation as a developer and manufacturer of intelligent braking systems and limit switches.



Ernst Schad GmbH

Seilerstr. 8, 44147 Dortmund

Tel.: +49 (0)231 985123-0

Fax: +49 (0)231 985123-9

E-Mail: sales@ernst-schad.de

www.ernst-schad.de

Production of gear wheels according to drawing or example.





Winergy

Am Industriepark 2, 46562 Voerde
Tel.: +49 (0)2871 92-4
Fax: +49 (0)2871 92-2487
E-Mail: info@winergy-group.com
www.winergy-group.com

With over 150 GW gearbox capacity supplied Winergy is the leading component manufacturer for wind turbines. Winergy offers gearboxes in a power range of 750 kW-10 MW and more, as well as service.



Interhydraulik company for hydraulic components with limited liability

Am Buddenberg 18, 59379 Selm
Tel.: +49 (0)2592 9780
Fax: +49 (0)2592 978100
E-Mail: info@interhydraulik.de
www.interhydraulik.com

As a specialist in hydraulic connecting technology, Interhydraulik offers a diverse range of pipelines, hose assemblies and screw connections for use in wind turbines.



perma-tec GmbH & Co. KG

Hammelburger Str. 21, 97717 Euerdorf
Tel.: +49 (0)9704 609-0
Fax: +49 (0)9704 609-50
E-Mail: info@perma-tec.com
www.perma-tec.com/en

The global leader in single-point lubrication systems. Precise lubrication of e.g. azimuth and pitch bearings helps to optimize workplace safety by extended exchange intervals.

Hydraulic components



DEUBLIN GmbH

Florenzallee 1, 55129 Mainz
Tel.: +49 (0)6122 8002-0
E-Mail: aschubert@deublin.de
www.deublin.eu

Providing the worldwide preferred solutions for reliable media transmission between nacelle and hub.



HAWE Hydraulik SE

Einsteinring 17, 805609 Aschheim/Munich
Tel.: +49 (0)89 379100-1000
Fax: +49 (0)89 379100-91000
E-Mail: info@hawe.de
www.hawe.com

HAWE Hydraulik – your competent partner for modern, efficient and durable hydraulic solutions in all areas of the wind industry.



Hilma-Römhheld GmbH

Schützenstr. 74, 57271 Hilchenbach
Tel.: +49 (0)2733 281-0
Fax: +49 (0)2733 281-169
E-Mail: info@hilma.de
www.rotorlock.de

ROEMHELD has introduced new rotor locks that are designed to deliver increased availability and simplified maintenance to wind power plants.



Liebherr-Components AG

Kirchweg 46, 5415 Nussbaumen AG/Switzerland
Tel.: +41 (0)56 296-4300
Fax: +41 (0)56 296-4301
E-Mail: components@liebherr.com
www.liebherr.com/cylinders
Hydraulic cylinders for the wind industry.

Lubricants & lubrication systems



ADDINOL Lube Oil GmbH

Am Haupttor, 06237 Leuna
Tel.: +49 (0)3461 845-0
Fax: +49 (0)3461 845-555
E-Mail: info@addinol.de
www.addinol.de
High-performance lubricants made in Germany for demanding applications in industry and the automotive sector.



BEKAWIND BAIER + KÖPPEL GmbH + CO. KG

Beethovenstrasse 14, 91257 Pegnitz / Bayern
Tel.: +49 (0)9241 729-0
Fax: +49 (0)9241 729-50
E-Mail: m.fremann@beka-lube.de
www.beka-lube.de
BEKA is a world-wide operating company with about 1200 employees. With 4 production sites in Germany and a global service network BEKA today is a leading manufacturer of central lubrication systems.



SKF Lubrication Systems Germany GmbH

Heinrich-Hertz-Str. 2–8, 69190 Walldorf
Tel.: +49 (0)211 209962-0
Fax: +49 (0)211 209962-40
E-Mail: Julia.Heggemann@skf.com
skf.com/WindLub, skf.com/lubrication
Centralized lubrication systems, gear rim lubrication, used lubricant removal, service and maintenance, control and monitoring units.



TOTAL Deutschland GmbH

Jean-Monnet-Str. 2, 10557 Berlin
Tel.: +49 (0)30 20276787
Fax: +49 (0)30 2027796634
E-Mail: rm.industrie@total.de
www.total.de/industrie
TOTAL is one of the leading companies in the global industrial sector and covers practically all areas of application for highly specialised lubricants, greases and specialties.

Seals & vibration control



DAFA Deutschland GmbH
Am Oxer 7, 24955 Harrislee
Tel.: +49 (0)461 57498536
Fax: +49 (0)461 574985369
E-Mail: info@dafa-germany.de
www.dafa-as.com

Our solutions help from the very beginning; enhancing the blade design so it lasts longer and assuring safe transportation from the factory to the construction site.



EFFBE GmbH
Hanauer Landstr. 16, 63628 Bad Soden-Salmünster
Tel.: +49 (0)6056 78-7400
Fax: +49 (0)6056 78-7966
E-Mail: info@effbe.de
www.effbe.de
Vibrator engineering & sealing with high performance elastomers, gearbox & generator mounts, torque arm, decoupling elements, CMS, R&D, manufacturing, test field, rubber & PUR, rubber-metal-compounds.



ESM Energie- u. Schwingungstechnik Mitsch GmbH
Energierasse 1, 64646 Heppenheim
Tel.: +49 (0)6252 6893-0
Fax: +49 (0)6252 6893-100
E-Mail: info@esm-gmbh.de
www.esm-gmbh.de
The vibration technology specialists. We provide gearbox supports (e. g. elastomer hydraulic, clamping bushings), generator mounts, low- and high-frequency tuned mass dampers, decoupling elements, cover mounts, couplings.



TECHNO-PARTS GmbH
Alte Bottroper Strasse 81, 45356 Essen
Tel.: +49 (0)201 86606-0
Fax: +49 (0)201 86606-68
E-Mail: vk@techno-parts.de
www.techno-parts.de
Seals/guide elements for hydraulics, pneumatics, chemicals, plant construction as well as for almost all parts of a wind turbine (rotor blade, brake, generator, gearbox, main shaft bearing, nacelle).



Wölfel Wind Systems GmbH
Max-Planck-Str. 15, 97204 Höchberg
Tel.: +49 (0)931 49708-0
Fax: +49 (0)931 49708-150
E-Mail: info@woelfel.de
www.woelfel.de
Measurement/Analysis of vibrations and stresses; Design, development, production and installation of passive and active damping devices for sound reduction and reduction of tower loads.

Surface technology



Sika Deutschland GmbH
Rieter Tal, 71665 Vaihingen/Enz
Tel.: +49 (0)7042 109-208
Fax: +49 (0)7042 109-5102
E-Mail: fries.achim@de.sika.com
www.sika.de
Protective coatings for wind turbines on-and offshore.

Synthetic Components



Röchling Engineering Plastics SE & Co. KG
Röchlingstr. 1, 49733 Haren
Tel.: +49 (0)5934 701-0
Fax: +49 (0)5934 701-299
E-Mail: info@roechling-plastics.com
www.roechling-industrial.com
For the development of wind turbines, Röchling offers a broad range of composites and thermoplastics used onshore and offshore by renowned manufacturers worldwide.

Tools & machine tools



alki TECHNIK GmbH
Unterlettenweg 4, 85051 Ingolstadt
Tel.: +49 (0)841 97499-0
Fax: +49 (0)841 97499-90
E-Mail: info@alkitronic.com
www.alkitronic.com/en
Development, Production and Distribution of high-quality and innovative products in the field of bolting systems – this is what alki TECHNIK GmbH stands for.



HYTORC Barbarino & Kilp GmbH
Justus-von-Liebig-Ring 17, 82152 Krailling near Munich
Tel.: +49 (0)89 230999-0
Fax: +49 (0)89 230999-14
E-Mail: p.junkers@hytorc.de
www.hytorc.de
Market leader for hydraulic and pneumatic bolting technology from 150 to 190,000 Nm; torque, rotation angle and yield strengths controlled. Fastest assembly methods, torsion-free and secure.



**M-PT Matjeschk-PowerTools**

Am Saegewerk 11, 01920 Ralbitz-Rosenthal
Tel.: +49 (0)35796 9760
E-Mail: mail@m-pt.de
www.m-pt.de

The experts for bolting technology in wind industry!
Our MED – electric torque wrench up to 16,500Nm with bolt check function and data logging. Authorised reseller for RAD Torque Systems.

**Plarad – Maschinenfabrik Wagner GmbH & Co. KG**

Birrenbachshöhe 17, 53804 Much
Tel.: +49 (0)2245 62-0
Fax: +49 (0)2245 62-66
E-Mail: info@plarad.de
www.plarad.de

Founded in 1962, Maschinenfabrik Wagner and its brand Plarad has stood for quality, innovation and reliability in the bolting technology sector for 50 years now and is a pioneer in the wind industry.

**SpanSet GmbH & Co. KG**

Juelicher Str. 49–51, 52532 Uebach-Palenberg
Tel.: +49 (0)2451 4831-0
Fax: +49 (0)2451 4831-8191
E-Mail: info@spanset.de
www.spanset.de

SpanSet GmbH & Co. KG is a production and sales company, serving customers and dealers, as well as agents and representatives from Germany, Austria and the Benelux countries.

Transport & logistics

Crane companies, crane hire & special transport

**Goldhofer Aktiengesellschaft**

Donaustrasse 95, 87700 Memmingen
Tel.: +49 (0)8331 15-0
Fax: +49 (0)8331 15-239
E-Mail: Info@goldhofer.com
www.goldhofer.com
Transport equipment for wind power plants

**Liebherr-MCctec Rostock GmbH**

Liebherrstrasse 1, 18147 Rostock
Tel.: +49 (0)381 6006-0
Fax: +49 (0)381 6006-3999
E-Mail: info.mcr@liebherr.com
www.liebherr.com
We produce offshore cranes with lifting capacities of up to 5,000 t for the wind energy sector. At the Rostock plant we offer the TCC 78000 heavy-lift crane with a load capacity of 1,600 t and a lifting height of 112 m for material handling.

**Liebherr-Werk Biberach GmbH**

Memminger Strasse 120, 88400 Biberach
Tel.: +49 (0)7351 41-0
Fax: +49 (0)7351 41-2225
E-Mail: info.lbc@liebherr.com
www.liebherr.com
Fast-erecting cranes. Top-slewing cranes. Mobile construction cranes. Special cranes for wind power.

**Liebherr-Werk Ehingen GmbH**

Dr. Hans Liebherr Strasse 1, 89584 Ehingen
Tel.: +49 (0)7391 502-0
Fax: +49 (0)7391 502-3399
E-Mail: info.lwe@liebherr.com
www.liebherr.com
Telescopic mobile cranes up to 1,200 t. Lattice boom mobile cranes 750 t. Telescopic crawler cranes up to 1,200 t. Crawler track cranes up to 3,000 t. Wind attachments. Narrow track crawler chassis.

**Liebherr-Werk Nenzing GmbH**

Dr. Hans Liebherr Strasse 1, 6710 Nenzing/Austria
Tel.: +43 (0)50809 41-0
Fax: +43 (0)50809 41-500
E-Mail: info.lwn@liebherr.com
www.liebherr.com
Crawler cranes up to 300 t.

**Schmidbauer GmbH & Co. KG**

Seeholzenstr. 1, 82166 Gräfelfing
Tel.: +49 (0)89 898676-0
Fax: +49 (0)89 851124
E-Mail: info@schmidbauer-gruppe.de
www.schmidbauer-gruppe.de
A capable and innovative expert for heavy-lifting equipment, throughout Europe. Schmidbauer is the market leader for mobile cranes, special transport, and installation work.

**Strothmann Machines & Handling GmbH**

Altenkamp 11, 33758 Schloss Holte-Stukenbrock
Tel.: +49 (0)5207 9122-100
Fax: +49 (0)5207 9122-196
E-Mail: info@strothmann.com
www.strothmann.com
Since the company was founded in 1976, the name STROTHMANN stands for innovations in the field of transport and handling technology. With great expertise in customer specific and special mechanical engineering, STROTHMANN is a reliable partner with an international sales and service network.



Manufacturer and supplier advisory board



Expert consulting advisory board



Investors' advisory board



Expert consulting advisory board



Scientific advisory board



Operators' advisory board

Companies A–Z

3Energy Unternehmensgruppe Planners & project developers	p. 221	Ammonit Measurement GmbH Measurement equipment & measuring masts	p. 228	BayWa r.e. Wind GmbH Planners & project developers	p. 221
A					
ABICON GmbH Company profile Planners & project developers	p. 124 p. 221	Ammonit Wind Tunnel GmbH Measurement equipment & measuring masts	p. 228	BDO ARBICON GmbH & Co. KG Company profile Tax accountants	p. 127 p. 211
ABO Wind AG Service, maintenance & repair	p. 212	anemos Gesellschaft fuer Umweltmeteorologie mbH Wind resource evaluators	p. 206	Becker Büttner Held Lawyers	p. 210
ABM Greiffenberger Antriebstechnik GmbH Electric actuator systems	p. 232	anemos-jacob GmbH Wind resource evaluators Measurement equipment & measuring masts	p. 206 p. 228	Beckhoff Automation GmbH & Co. KG Company profile Controls, cables & switchgear cabinets	p. 87 p. 226
ABO Wind AG Company profile Technical & commercial operational management Planners & project developers	p. 125 p. 216 p. 221	Aon Versicherungsmakler Deutschland GmbH Insurance companies	p. 210	BEE – German Renewable Energy Federation Associations	p. 218
Ackermann & Knorr Ingenieur GmbH Technical consultants	p. 204	August Friedberg GmbH Bolts & fasteners	p. 231	BEKAWIND BAIER + KÖPPEL GmbH + CO. KG Lubricants & lubrication systems	p. 233
ADDINOL Lube Oil GmbH Lubricants & lubrication systems	p. 233	AURELO business IT-solutions GmbH Software solutions	p. 219	BET Büro für Energiewirtschaft und technische Planung GmbH Consulting & business consulting	p. 209
B					
Aero Enterprise GmbH Company profile Service, maintenance & repair	p. 126 p. 212	Bachmann electronic GmbH Company profile	p. 84	BIL eG Company profile Service, maintenance & repair	p. 130 p. 212
Agentur für Wirtschaftsförderung Cuxhaven Offshore	p. 220	Bachmann Monitoring GmbH Company profile Condition monitoring systems	p. 85 p. 226	blade care Academy Education & training	p. 202
AIRWIN GmbH Technical & commercial operational management	p. 216	Balluff GmbH Company profile Sensors	p. 88 p. 229	blade care GmbH Service, maintenance & repair	p. 212
Aktiva Gruppe Lawyers Tax accountants	p. 210 p. 211	Barksdale GmbH Sensors	p. 229	Blanke Meier Evers Lawyers	p. 210
alki TECHNIK GmbH Tools & machine tools	p. 234	BayWa r.e. Clean Energy Sourcing GmbH Direct marketers Energy services	p. 202 p. 203	BMR energy solutions GmbH Planners & project developers	p. 221
AllCon Service & Dienstleistungs GmbH Human resource services	p. 218	BayWa r.e. Operation Services GmbH Technical & commercial operational management	p. 216	Boehm-Bezing & Cie. GmbH Consulting & business consulting	p. 209
AL-PRO GmbH & Co. KG Measurement equipment & measuring masts Wind resource evaluators	p. 228 p. 206	BayWa r.e. renewable energy GmbH Company profile Planners & project developers	p. 129 p. 221	BRAUER Maschinenteknik AG Service, maintenance & repair Gears	p. 212 p. 232
ALTUS AG Planners & project developers	p. 221	BayWa r.e. Rotor Service GmbH Service, maintenance & repair	p. 212	Buse Heberer Fromm Rechtsanwälte Steuerberater PartG mbB Lawyers	p. 210

An overview of all categories
is inside the back cover page. ►

Buss Wind Services GmbH Service, maintenance & repair	p. 213	DEKRA Automobil GmbH Technical consultants	p. 204	Deutsche Windtechnik Training Center Viöl Education & training	p. 203
BWE – German Wind Energy Association Associations	p. 218	DEUBLIN GmbH Company profile Hydraulic components	p. 90 p. 233	Deutsche Windtechnik Umspannwerke GmbH Grids & grid connection	p. 220
BWT Bavnick Wind-Technik GmbH Technical consultants	p. 204	Deutsche Kreditbank AG Company profile Banks, financial institutions & financial service providers	p. 133 p. 208	Deutsche Windtechnik X-Service GmbH Service, maintenance & repair	p. 213
C		Deutsche Messe AG Company profile Trade fairs & conferences for the wind energy industry	p. 134 p. 219	Dirkshof / EED GmbH & Co. KG Technical & commercial operational management	p. 216
CENTA Antriebe Kirschev GmbH Coupling	p. 232	Deutsche WindGuard Technical consultants Wind resource evaluators Consulting & business consulting	p. 204 p. 206 p. 209	Dr. Augustin Planungsbüro für Umwelttechnik Planners & project developers	p. 221
Centrica Energy Trading GmbH Direct marketers	p. 202	Deutsche Windtechnik Technical & commercial operational management Software solutions Measurement equipment & measuring masts	p. 216 p. 219 p. 228	Dr. jur. Jörg Niedersberg Lawyers	p. 210
CMblu Energy AG Start-up	p. 60	Deutsche WindGuard Offshore GmbH Safety training Offshore	p. 203 p. 220	Dunoair Windpark Planung GmbH Company profile Planners & project developers	p. 136 p. 221
cms@wind GmbH Start-up	p. 62	Deutsche Windtechnik Company profile Service, maintenance & repair	p. 135 p. 213	DZ BANK AG Banks, financial institutions & financial service providers	p. 208
Commerz Real Kapitalverwaltungsgesellschaft mbH Fund providers	p. 209	Deutsche Windtechnik Company profile Service, maintenance & repair	p. 135 p. 213	E	
Connected Wind Services Deutschland GmbH Company profile Service, maintenance & repair	p. 131 p. 213	Deutsche Windtechnik Offshore und Consulting GmbH Service, maintenance & repair	p. 213	EcofinConcept GmbH Consulting & business consulting	p. 209
Contrust Versicherungsmakler GmbH Insurance companies	p. 210	Deutsche Windtechnik Repowering GmbH & Co. KG Repowering	p. 225	EDF EN Deutschland GmbH Planners & project developers	p. 221
cp.max Rotortechnik GmbH & Co. KG Service, maintenance & repair	p. 213	Deutsche Windtechnik Rotor und Turm GmbH & Co. KG Service, maintenance & repair	p. 213	EEW Special Pipe Constructions GmbH Foundations & footings	p. 230
CWD Aachen GmbH – Center for Wind Power Drives Innovative projects Company profile Development & construction	p. 40 p. 132 p. 218	Deutsche Windtechnik Service GmbH & Co. KG Service, maintenance & repair	p. 213	EFFBE GmbH Seals & vibration control	p. 234
D		Deutsche Windtechnik Steuerung GmbH & Co. KG Controls, cables & switchgear cabinets	p. 226	EFI Wind GmbH Planners & project developers	p. 222
DAFA Deutschland GmbH Company profile Seals & vibration control Towers Rotor blades & rotor blade materials Foundations & footings	p. 89 p. 234 p. 230 p. 230 p. 230	Deutsche Windtechnik Training Center Bremen Safety training	p. 203	ELIN Motoren GmbH Generators	p. 228
DAL Deutsche Anlagen-Leasing GmbH & Co. KG Banks, financial institutions & financial service providers	p. 208	ELMEKO GmbH + Co. KG Cooling & climatisation	p. 227	EMD Deutschland GbR Company profile Education & training Software solutions	p. 137 p. 203 p. 219

enbreeze GmbH Start-up	p. 64	eno energy Gruppe Company profile Wind turbines	p. 75 p. 211	Fichtner GmbH & Co. KG Company profile Planners & project developers	p. 146 p. 222
EnBW Energie Baden-Württemberg AG Company profile Direct marketers Service, maintenance & repair Technical & commercial operational management Repowering	p. 138 p. 202 p. 213 p. 216 p. 225	enosite GmbH Planners & project developers	p. 222	FLYTEG GmbH & Co. KG Service, maintenance & repair	p. 213
ENERCON GmbH Company profile Wind turbines	p. 73 p. 211	enovation GmbH Development & construction	p. 218	fos4X GmbH Company profile Software solutions	p. 147 p. 219
ENERGIEALLIANZ Bayern GmbH & Co. KG Company profile Planners & project developers	p. 139 p. 222	Enser Versicherungskontor GmbH Insurance companies	p. 210	Framatome GmbH Company profile Service, maintenance & repair	p. 148 p. 213
Energie profile Ingenieurbüro Glocker Technical consultants	p. 204	enveco GmbH Technical consultants	p. 205	G	
Energiequelle GmbH Company profile Planners & project developers	p. 141 p. 222	envia THERM GmbH Company profile Planners & project developers	p. 144 p. 222	GAIA mbH Company profile Service, maintenance & repair Planners & project developers	p. 149 p. 214 p. 222
Energy Invest Consulting AG Banks, financial institutions & financial service providers	p. 208	eologix sensor technology gmbh Sensors	p. 229	GELSENWASSER AG Planners & project developers	p. 222
energy & meteo systems GmbH Forecasting services providers	p. 202	Ernst Schad GmbH Gears	p. 232	GEO-NET Umweltconsulting GmbH Wind resource evaluators	p. 206
ENERTRAG AG Planners & project developers	p. 222	ESM Energie- u. Schwingungstechnik Mitsch GmbH Seals & vibration control	p. 234	GE Renewable Energy Wind turbines	p. 211
ENERTRAG EnergiInvest GmbH Fund providers	p. 209	EWE ERNEUERBARE ENERGIEN GmbH Company profile Planners & project developers	p. 143 p. 222	GEWI AG Direct marketers	p. 202
ENERTRAG Service GmbH Service, maintenance & repair	p. 213	EWE TRADING GmbH Direct marketers	p. 202	GfM Gesellschaft für Maschinendiagnose mbH Company profile Technical consultants Service, maintenance & repair Condition monitoring systems	p. 150 p. 205 p. 214 p. 226
ENERTRAG Windstrom GmbH Technical & commercial operational management	p. 216	EWS Consulting GmbH Wind resource evaluators Planners & project developers	p. 206 p. 222	Goldhofer Aktiengesellschaft Crane companies, crane hire & special transport	p. 235
EnerVest Deutschland GmbH Planners & project developers	p. 222	expert office Dipl.-Ing. Harald Eden Technical consultants	p. 205	GOM GmbH Quality assurance	p. 212
enervis energy advisors GmbH Consulting & business consulting	p. 209	F		goracon systemtechnik gmbh Access technology	p. 231
Engemann und Partner, Rechtsanwälte mbB Lawyers	p. 210	FAKON Wind GmbH Technical consultants	p. 205	GP JOULE GmbH Company profile Planners & project developers	p. 151 p. 223
		FGH – Forschungsgemeinschaft für elektrische Anlagen und Stromwirtschaft e.V Company profile Certification	p. 145 p. 204	GP JOULE Projects GmbH & Co. KG Sector Coupling	p. 225

An overview of all categories
is inside the back cover page. ►

GP JOULE Service GmbH & Co. KG Technical & commercial operational management	p. 216	HEICO Befestigungstechnik GmbH Bolts & fasteners	p. 231
Gram & Juhl A/S Company profile Condition monitoring systems	p. 91 p. 226	HELUKABEL GmbH Company profile Controls, cables & switchgear cabinets	p. 92 p. 226
Greenmatch AG Innovative projects Company profile Software solutions	p. 42 p. 154 p. 219	Hilma-Römheld GmbH Hydraulic components	p. 233
Green Wind Offshore GmbH Company profile Service, maintenance & repair	p. 153 p. 214	HYTORC Barbarino & Kilp GmbH Tools & machine tools	p. 234
Green Wind Operations GmbH Innovative projects Company profile Technical & commercial operational management	p. 44 p. 153 p. 216	I iE-Renewables Ingenieurbüro für Erneuerbare Energien Technical consultants Planners & project developers	p. 205 p. 223
Grzib Elektrotechnik GmbH & Co. KG Company profile Service, maintenance & repair	p. 155 p. 214	Ingenieurbüro Andresen Technical consultants	p. 205
GWU-Umwelttechnik GmbH Measurement equipment & measuring masts	p. 228	Ingenieurbüro Jan Teut Planners & project developers	p. 223
H		Ingenieurbüro Kuntzsch GmbH Wind resource evaluators	p. 207
Hailo Wind Systems GmbH & Co. KG Access technology	p. 231	in.power GmbH Company profile Direct marketers	p. 160 p. 202
Hamburg Commercial Bank AG Company profile Banks, financial institutions & financial service providers	p. 157 p. 208	Interhydraulik company for hydraulic components with limited liability Company profile Hydraulic components	p. 93 p. 233
Hamburg Messe und Congress GmbH Company profile Trade fairs & conferences for the wind energy industry	p. 158 p. 219	Investitionsbank Schleswig-Holstein (IB.SH) Banks, financial institutions & financial service providers	p. 208
HAWART Sondermaschinenbau GmbH Rotor blades & rotor blade materials	p. 230	Isoblock Schaltanlagen GmbH & Co. KG Transformers, converters & power resistors	p. 229
HAWE Hydraulik SE Hydraulic components	p. 233	iTerra energy GmbH Planners & project developers	p. 223
HD-Technic GmbH Technical consultants	p. 205	J	
		Jade NaturEnergie GmbH & Co. KG Planners & project developers	p. 223
		Jadewind GmbH & Co. KG Technical consultants	p. 205
		Jetstream Bosse Ing.-Büro für Windenergienutzung Technical consultants	p. 205
		JUMO GmbH & Co. KG Sensors	p. 229
		juwi AG Company profile Planners & project developers	p. 162 p. 223
		juwi Operations & Maintenance GmbH Company profile Technical & commercial operational management	p. 163 p. 216
		K	
		Kaiserwetter Energy Asset Management GmbH Technical & commercial operational management	p. 216
		Käufer Befahrtechnik Gebr. GmbH Access technology	p. 231
		Koopmann Gruppe Innovative projects Company profile Service, maintenance & repair	p. 46/48 p. 161 p. 214
		KÖTTER Consulting Engineers GmbH & Co. KG Technical consultants	p. 205
		KRAFTWERKSSCHULE e. V. (KWS) Education & training	p. 203
		Kreuzwind Schmieder & Schmidt GbR Service, maintenance & repair	p. 214
		KTW Umweltschutztechnik GmbH Service, maintenance & repair Foundations & footings	p. 214 p. 230
		Kübler Group Controls, cables & switchgear cabinets Sensors	p. 226 p. 229

L	M	N
Landstrom GmbH & Co. KG Energy services p. 203	Max Bögl Wind AG Innovative projects p. 50 Company profile p. 96 Towers p. 230	Nefino GmbH Start-up p. 68
Landwind-Gruppe Planners & project developers p. 223	mayr power transmission Brakes p. 232 Coupling p. 232	Netze BW GmbH Company profile p. 168 Grids & grid connection p. 220
Landwirtschaftliche Rentenbank Banks, financial institutions & financial service providers p. 208	Menold Bezler Rechtsanwälte Partnerschaft mbB Lawyers p. 211	NGC Transmission Europe GmbH Company profile p. 97 Gears p. 232
Lanthan GmbH & Co. KG Aviation obstruction markers & lighting systems p. 225	Messe Husum & Congress GmbH & Co. KG Company profile p. 159 Trade fairs & conferences for the wind energy industry p. 219	Nidec SSB Wind Systems GmbH Company profile p. 98 Controls, cables & switchgear cabinets p. 227
LAP GmbH Laser Applikationen Rotor blades & rotor blade materials p. 230	METEK Meteorologische Messtechnik GmbH Measurement equipment & measuring masts p. 229	Nölting GmbH – AGENTUR für Unternehmens- kommunikation Media & communication p. 218
LAPP (U.I. Lapp GmbH) Company profile p. 95 Controls, cables & switchgear cabinets p. 227	Meteorologisches Beratungsbüro, Dr. S. Theunert Wind resource evaluators p. 207	Nordex Group Company profile p. 77 Wind turbines p. 212
The Liebherr Group Company profile p. 165	M.O.E. GmbH Certification p. 204	NORD/LB Company profile p. 169 Banks, financial institutions & financial service providers p. 208
Liebherr-Components AG Transformers, converters & power resistors p. 229 Bearings p. 231 Gears p. 232 Hydraulic components p. 233	Moeller & Poeller Engineering GmbH (M.P.E.) Grids & grid connection p. 220	Nordwest Assekuranzmakler GmbH & Co. KG Insurance companies p. 210
Liebherr-MCCtec Rostock GmbH Crane companies, crane hire & special transport p. 235	M.O.S.S. Computer Grafik Systeme GmbH Company profile p. 166 Software solutions p. 219	NOTUS energy Company profile p. 170 Planners & project developers p. 223
Liebherr-Werk Biberach GmbH Crane companies, crane hire & special transport p. 235	MOWEA GmbH Start-up p. 66	NSK Deutschland GmbH Company profile p. 99 Bearings p. 231
Liebherr-Werk Ehingen GmbH Crane companies, crane hire & special transport p. 235	M-PT Matjeschk-PowerTools Tools & machine tools p. 235	N.T.E.S. GmbH Company profile p. 167 Service, maintenance & repair p. 214
Liebherr-Werk Nenzing GmbH Crane companies, crane hire & special transport p. 235	MTS Sensor Technologie GmbH & Co. KG Measurement equipment & measuring masts p. 229	
	Multigear GmbH Service, maintenance & repair p. 214	

An overview of all categories
is inside the back cover page. ►

O

OAT GmbH
Controls, cables & switchgear cabinets p. 227

OffTEC Base GmbH & Co. KG
Safety training p. 203

Osborne Clarke Rechtsanwälte Steuerberater Partnerschaft mbB
Lawyers p. 211

OSTWIND Erneuerbare Energien GmbH
Planners & project developers p. 223

OX2 Wind Deutschland GmbH
Repowering p. 225

P

Parasol GmbH & Co. KG
Aviation obstruction markers
& lighting systems p. 225

Pavana GmbH
Wind resource evaluators p. 207

perma-tec GmbH & Co. KG
Company profile p. 100
Lubricants & lubrication systems p. 233

Peter Chr. Petersen GmbH & Co. KG
Foundations & footings p. 230

PIONEXT GmbH
Company profile p. 171
Energy services p. 203
Technical & commercial
operational management p. 217
Planners & project developers p. 223

PLANKon Ing.-Büro für Windenergieprojekte
Wind resource evaluators p. 207
Planners & project developers p. 223

Plarad – Maschinenfabrik Wagner GmbH & Co. KG
Tools & machine tools p. 235

PNE AG
Company profile p. 172
Planners & project developers p. 223

POLYGONVATRO GmbH
Service, maintenance & repair p. 214

Power of Nature – Windenergie
Wind resource evaluators p. 207

Prowind GmbH
Planners & project developers p. 224

Prysman Kabel und Systeme GmbH
Company profile p. 101
Controls, cables & switchgear cabinets p. 227

psm Nature Power Service & Management GmbH & Co. KG
Company profile p. 173
Service, maintenance & repair p. 214
Technical & commercial
operational management p. 217

Q

QV LUX GmbH
Company profile p. 102
Aviation obstruction markers
& lighting systems p. 226

R

Ramboll
Company profile p. 175
Wind resource evaluators p. 207
Offshore p. 220
Planners & project developers p. 224

REA GmbH Management
Planners & project developers p. 224

reconcept. Green Global Investments
Banks, financial institutions
& financial service providers p. 208

REETEC GmbH
Education & training p. 203
Service, maintenance & repair p. 214
Offshore p. 220
Aviation obstruction markers
& lighting systems p. 226

Regenerative Energien Zernsee GmbH & Co. KG
Company profile p. 176
Technical & commercial
operational management p. 217

reko Windenergie-Analysen
Wind resource evaluators p. 207

RENK AG
Coupling p. 232
Gears p. 232

RES Deutschland GmbH
Innovative projects p. 52
Company profile p. 177
Planners & project developers p. 224

REWITEC GmbH
Service, maintenance & repair p. 215

Rittal GmbH & Co. KG
Company profile p. 103
Controls, cables & switchgear cabinets p. 227

Röchling Engineering Plastics SE & Co. KG
Company profile p. 104
Synthetic Components p. 234

ROSCH Industrieservice GmbH
Company profile p. 178
Service, maintenance & repair p. 215

Rotor Control GmbH
Service, maintenance & repair p. 215

RTS Wind AG
Service, maintenance & repair p. 215

Rübsamen Windenergie GmbH
Planners & project developers p. 224

R+V Versicherung AG
Company profile p. 174
Insurance companies p. 210

RWP Rechtsanwälte PartG mbB
Lawyers p. 211

S

Sabowind GmbH
Planners & project developers p. 224
Repowering p. 225

Sabowind Service GmbH
Technical & commercial
operational management p. 217

SCADA International Deutschland GmbH
Software solutions p. 219
Grids & grid connection p. 220
Controls, cables & switchgear cabinets p. 227

Schaeffler Monitoring Services GmbH
Condition monitoring systems p. 226

Schaeffler Technologies AG & Co. KG		STEGO Elektrotechnik GmbH		TÜV NORD EnSys GmbH & Co. KG	
Company profile	p. 107	Company profile	p. 114	Company profile	p. 181
Bearings	p. 231	Cooling & climatization	p. 227	Wind resource evaluators	p. 207
<hr/>					
Schmidbauer GmbH & Co. KG		Sterr-Kölln & Partner mbB		TÜV Rheinland Industrie Service GmbH	
Crane companies, crane hire & special transport	p. 235	Lawyers	p. 211	Technical consultants	p. 205
<hr/>					
Schneider Electric GmbH		Stromag GmbH		TÜV SÜD Industrie Service GmbH	
Energy & data transmission	p. 228	Gears	p. 232	Certification	p. 204
<hr/>					
Schraubenwerk Zerbst GmbH		Strothmann Machines & Handling GmbH		Technical consultants	p. 205
Company profile	p. 105	Company profile	p. 180	Wind resource evaluators	p. 207
Bolts & fasteners	p. 231	Crane companies, crane hire & special transport	p. 235	Offshore	p. 221
<hr/>					
Schunk Carbon Technology		Sulzer & Schmid Laboratories AG		U	
Energy & data transmission	p. 228	Service, maintenance & repair	p. 215	UKA – Umweltgerechte Kraftanlagen GmbH & Co. KG	
<hr/>					
SHE Solution Bergmann GmbH & Co. KG		T		Company profile	p. 183
Safety training	p. 203	<hr/>			
Safety features & equipment	p. 229	Taylor Wessing		Planners & project developers	p. 224
<hr/>					
SICK AG		Lawyers	p. 211	UL DEWI-OCC	
Safety features & equipment	p. 229	<hr/>			
<hr/>					
Siemens AG		TECHNO-PARTS GmbH		Offshore and Certification Centre GmbH	
Company profile	p. 109	Sealing and Plastics Technology		Certification	p. 204
Safety features & equipment	p. 229	Company profile	p. 115	<hr/>	
<hr/>					
Siemens Gamesa Renewable Energy GmbH & Co. KG		Seals & vibration control	p. 234	UL International GmbH	
Company profile	p. 79	<hr/>			
Wind turbines	p. 212	THEOLIA Natureenergien GmbH		Wind resource evaluators	p. 207
<hr/>					
Sika Deutschland GmbH		Technical & commercial operational management	p. 217	UmweltBank AG	
Surface technology	p. 234	<hr/>			
Offshore	p. 220	THEVA		Banks, financial institutions & financial service providers	p. 208
<hr/>					
SKF Lubrication Systems Germany GmbH		Innovative projects	p. 56	V	
Lubricants & lubrication systems	p. 233	<hr/>			
<hr/>					
SpanSet Axzion GmbH		thyssenkrupp rothe erde Germany GmbH		VENSYS Energy AG	
Company profile	p. 113	Company profile	p. 118	Company profile	p. 81
Service, maintenance & repair	p. 215	Bearings	p. 231	Wind turbines	p. 212
<hr/>					
SpanSet GmbH & Co. KG		TOTAL Deutschland GmbH		Ventur GmbH	
Company profile	p. 112	Company profile	p. 117	Towers	p. 230
Tools & machine tools	p. 235	Lubricants & lubrication systems	p. 233	<hr/>	
<hr/>					
Statkraft Markets GmbH		Tractebel Engineering GmbH		VERBUND	
Innovative projects	p. 54	Wind resource evaluators	p. 207	Company profile	p. 184
Company profile	p. 179	Consulting & business consulting	p. 209	Direct marketers	p. 202
Direct marketers	p. 202	Offshore	p. 220	<hr/>	
<hr/>					
TRICON Assets GmbH		Planners & project developers	p. 224	Volkswind GmbH	
Software solutions	p. 219	<hr/>			
<hr/>					
Triflex GmbH & Co. KG		Volta Windkraft GmbH		Company profile	p. 185
Service, maintenance & repair	p. 215	Technical & commercial operational management	p. 217	Planners & project developers	p. 224
<hr/>					
<hr/>					
VSB Gruppe					
				Company profile	p. 186
				Planners & project developers	p. 224
<hr/>					

An overview of all categories
is inside the back cover page. ►

VS Service GmbH Technical & commercial operational management	p. 217	Windservice Westerwald GmbH Service, maintenance & repair	p. 215
VS Technik GmbH Service, maintenance & repair	p. 215	WindStrom Erneuerbare Energien GmbH & Co. KG Planners & project developers	p. 224
W		Wind-Tech Services Rechlin GmbH Company profile Service, maintenance & repair	p. 187 p. 215
Weidmüller GmbH & Co. KG Company profile Controls, cables & switchgear cabinets	p. 119 p. 227	Wind-Tech Services Rechlin GmbH Special Unit Technical consultants	p. 206
Weidmüller Monitoring Systems GmbH Condition monitoring systems	p. 226	windtest grevenbroich gmbh Technical consultants	p. 206
Weitkowitz GmbH Company profile Energy & data transmission	p. 120 p. 228	Windwärts Energie GmbH Company profile Technical & commercial operational management Planners & project developers Repowering	p. 188 p. 217 p. 225 p. 225
WestWind Projektierungs GmbH & Co. KG Planners & project developers	p. 224	Winergy Company profile Service, maintenance & repair Gears	p. 121 p. 215 p. 233
WestWind Service GmbH & Co. KG Technical & commercial operational management	p. 217	WKA Blade Service GmbH Service, maintenance & repair	p. 215
Wieland Electric GmbH Controls, cables & switchgear cabinets	p. 227	WKN GmbH Company profile Planners & project developers	p. 189 p. 225
WIND-certification GmbH Certification	p. 204	Wölfel Wind Systems GmbH Company profile Technical consultants Condition monitoring systems Seals & vibration control	p. 190 p. 206 p. 226 p. 234
WIND-consult GmbH Technical consultants Wind resource evaluators Offshore	p. 206 p. 207 p. 221	wpd windmanager GmbH & Co. KG Company profile Technical & commercial operational management	p. 191 p. 217
windexperts Prüfgesellschaft mbH Technical consultants	p. 206	WT Energiesysteme GmbH Grids & grid connection	p. 220
WindGuard Certification Certification	p. 204	WTSH – Business Development and Technology Transfer Corporation of Schleswig-Holstein GmbH Institutions	p. 218
Wind Multiplikator GmbH Consulting & business consulting	p. 209		
Wind Multiplikator QHSE GmbH Consulting & business consulting	p. 209		
Windrad Engineering GmbH Development & construction	p. 218		
Windräder Ingenieurbüro Cerbe & Dr. Rische Technical consultants	p. 206		

Picture credits

Photos and graphics in the company profiles were provided by the respective companies.

Imprint

BWE Industry Report Wind Industry in Germany

Publisher:

Legally responsible for content:
Bundesverband WindEnergie e. V. (BWE)
represented by the President

Concept: Thorsten Paulsen, Benjamin Gruhn, Marie Kunath

Editorial team:

neue energie – das magazin für klimaschutz
und erneuerbare energien. Autor: Michael Hahn

9th edition, September 2019

Print run, German: 15,000 copies

Print run, English: 7,500 copies

Order address:

Bundesverband WindEnergie e.V. (BWE)
Neustädtische Kirchstr. 6
10117 Berlin, Germany
Tel.: +49 (0)30 21 23 41-210
Fax: +49 (0)30 21 23 41-410
bestellung@wind-energie.de

Sector portal:

www.windindustry-in-germany.com

Advertising / Company profiles:

Bundesverband WindEnergie e. V.

Tel.: +49 (0)30 21 23 41-210

Klaus Barkeling (k.barkeling@wind-energie.de; Tel: -177)

Nikos Fucicis (n.fucicis@wind-energie.de; Tel.: -178)

Design / Layout:

Mike Müller Visuelle Kommunikation

mail@muellerstudio.de

www.muellerstudio.de

Translation:

Kira Gee

kira.gee@gmx.de

www.echoo.de

Printing:

Müller Ditzen AG

Hoebelstr. 19

27572 Bremerhaven, Germany



wind-turbine.com

GLOBAL MARKETPLACE



Windindustry
in Germany



IDENTIFY NEW MARKETS



The world's leading online marketplace for plant operators, investors, suppliers, service providers and manufacturers. Get in touch with buyers and sellers from over 190 countries and take advantage of new business opportunities.

Reach the right partners with “Wind Industry in Germany”

The edition is distributed by the German Wind Energy Association as part of its ongoing work. The industry report “Wind Industry in Germany” is also distributed free of charge at **all sector events** in Germany, at **large international events** and by our cooperation partners.

Selected cooperation partners:



Twice the visibility of your entry online

All company profiles featured in this edition are also displayed on www.windindustrie-in-deutschland.de (Sector portal of the BWE) and www.wind-turbine.com (largest online marketplace for wind energy)



**You are interested in a media partnership with “Wind Industry in Germany”?
Contact us:**

Benjamin Gruhn, Senior Produktmanager
Corporate Publishing,
Tel.: +49 (0)30 212341-164,
b.gruhn@wind-energie.de
www.windindustrie-in-deutschland.de

Category overview

Here we list all companies by the services and products they offer.
An alphabetical list of companies is on page 236.

<p>Direct marketing </p> <hr/> <p>Direct marketers p. 202 Forecasting services providers p. 202</p>	<p>Operation & service </p> <hr/> <p>Quality assurance p. 212 Service, maintenance & repair p. 212 Technical & commercial operational management p. 216</p>	<p>Suppliers of electrical and electronic components </p> <hr/> <p>Aviation obstruction markers & lighting systems p. 225 Condition monitoring systems p. 226 Controls, cables & switchgear cabinets p. 226 Cooling & climatisation p. 227 Energy & data transmission p. 228 Generators p. 228 Measurement equipment & measuring masts p. 228 Safety features & equipment p. 229 Sensors p. 229 Transformers, converters & power resistors p. 229</p>
<p>Education & training </p> <hr/> <p>Education & training p. 202 Safety training p. 203</p>	<p>Organisations & public institutions </p> <hr/> <p>Associations p. 218 Institutions p. 218</p>	<p>Suppliers of large components </p> <hr/> <p>Foundations & footings p. 230 Rotor blades & rotor blade materials p. 230 Towers p. 230</p>
<p>Energy services </p> <hr/> <p>Energy services p. 203</p>	<p>Other services </p> <hr/> <p>Development & construction p. 218 Human resource services p. 218 Media & communication p. 218 Software solutions p. 219 Trade fairs & conferences for the wind energy industry p. 219</p>	<p>Suppliers of mechanical components </p> <hr/> <p>Access technology p. 231 Bearings p. 231 Bolts & fasteners p. 231 Brakes p. 232 Coupling p. 232 Electric actuator systems p. 232 Gears p. 232 Hydraulic components p. 233 Lubricants & lubrication systems p. 233 Seals & vibration control p. 234 Surface technology p. 234 Tools & machine tools p. 234 Synthetic components p. 234</p>
<p>Experts </p> <hr/> <p>Certification p. 204 Technical consultants p. 204 Wind resource evaluators p. 206</p>	<p>Planning </p> <hr/> <p>Grids & grid connection p. 220 Offshore p. 220 Planners & project developers p. 221 Repowering p. 225</p>	<p>Transport & logistics </p> <hr/> <p>Crane companies, crane hire & special transport p. 235</p>
<p>Finance & law </p> <hr/> <p>Banks, financial institutions & financial service providers p. 208 Consulting & business consulting p. 209 Fund providers p. 209 Insurance companies p. 210 Lawyers p. 210 Tax accountants p. 211</p>	<p>Sector Coupling </p> <hr/> <p>Sector Coupling p. 225</p>	
<p>Manufacturers </p> <hr/> <p>Wind turbines (> 100 kW) p. 211</p>		

